

Global LED lighting portfolio

CROUSE-HINDS
SERIES

Safe. Reliable. Efficient.

Global LED solutions for harsh and hazardous environments



EATON

Powering Business Worldwide

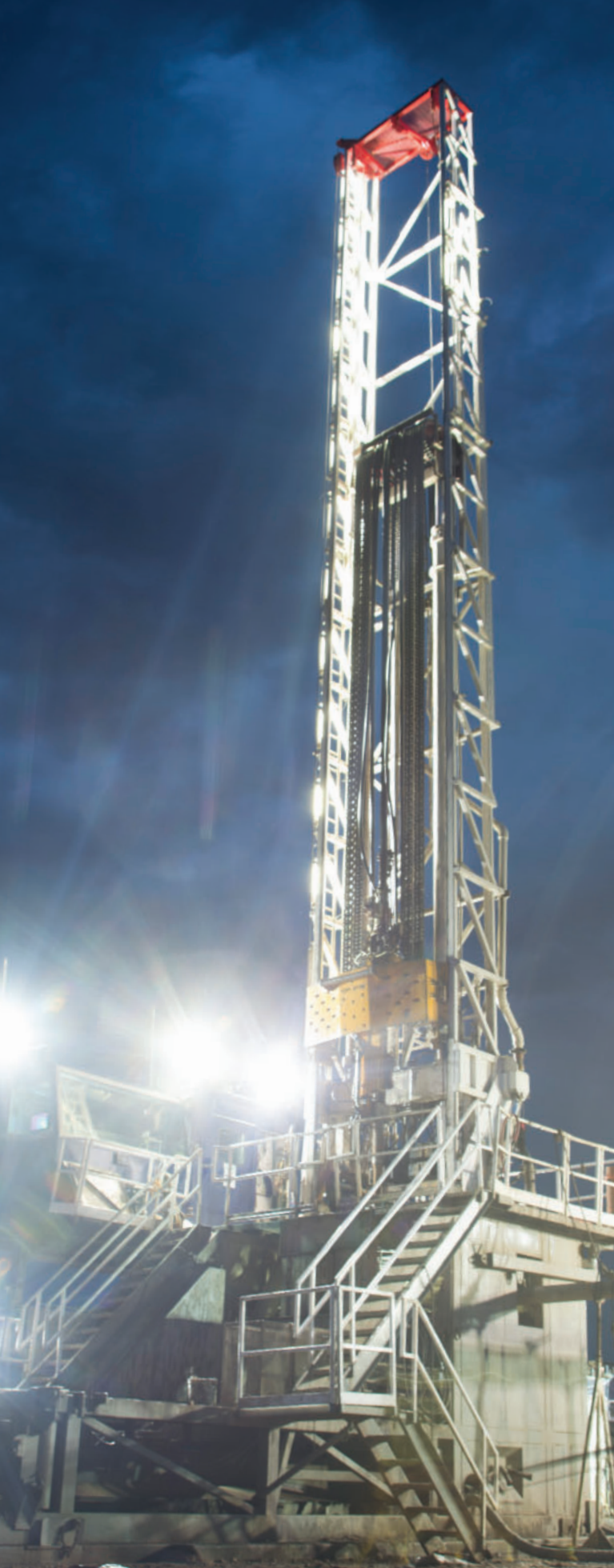

Global LED solutions for harsh and hazardous environments

Safe. Reliable. Efficient.

Featuring the industry's broadest range of LED luminaires for harsh, hazardous and industrial environments, Eaton's Crouse-Hinds Division can deliver a lighting solution that performs safely and reliably in even the worst operating conditions. All the while reducing your energy, maintenance and manpower costs.

Why LED?

Energy efficiency

LED average energy consumption is significantly less than traditional fluorescent and HID fixtures

Start/restart time

Instant illumination vs. 10 minute restrike time for HID

Light quality

Higher color rendering compared to fluorescent and HID

Environmental benefits

Mercury-free LED eliminates disposal costs and lowers energy consumption for a smaller carbon footprint

Why Crouse-Hinds?

Industry-best reliability

Built to withstand a wide array of applications

Thermal management

Effective heat sinking ensures longer life

Quality of light

Custom optics designed to maximize light distribution and intensity

Globally certified

Designed to global specifications for NEC and IEC applications, including many local certifications for regional markets











Serviceable drivers

Easy access to drivers for service or replacement

Crouse-Hinds series LED family selection guide

Find out which solution is right for you

Selection guide – Hazardous areas

Area classification	Application	Product	Equivalent light output	Lumen level	Temp Range†	Emergency battery option	DLC qualified
Class I, Division 2, Class II and/or Zone 2 & Zone 22	Flood cUL US LISTED ABS IECEx Ex	Champ™ FMVA 	11 models - 70W to 1500W HID replacement	3,300 - 50,500 lumens	+65°C -40°C		DLC <i>(select models)*</i>
	High/mid bay cUL US LISTED ABS IECEx Ex	Champ™ VMVL 	9 models - 70W to 1000W HID replacement	3,250 - 26,500 lumens	+65°C -40°C	✓	DLC <i>(select models)*</i>
	High/mid bay cUL US LISTED	Champ™ VMV Connected 	5 models - 70W to 400W HID replacement	3,300 - 11,300 lumens	+65°C -40°C		DLC <i>(select models)*</i>
	Mid/low bay IECEx Ex	NLE 	4 models - 70W to 175W HID replacement	3,000 - 8,000 lumens	+55°C -40°C		N/A
Class I, Division 2, Class II and/or Zone 2 & Zone 22	Linear cUL US LISTED ABS	Champ™ MLLA 	2 models - 2 lamp T5HO replacement	3,700 - 7,900 lumens	+65°C -40°C	✓	DLC <i>(select models)*</i>
	Linear cUL US LISTED NSF	Pauluhn™ Summit 	3 models - up to 6 lamp T5HO replacement	13,000 - 25,100 lumens	+55°C -40°C		DLC <i>(select models)*</i>
	Linear Ex	CEAG nLLK15 	2 models - 2x18W, 2x36W and 2x58W fluorescent replacement	2,100 - 9,300 lumens	+50°C -25°C	✓	N/A
	Linear IECEx Ex	nHLL 	4 models - 2x18W, 2x36W and 2x58W fluorescent replacement	3,000 - 8,000 lumens	+55°C -40°C	✓	N/A
	Low bay cUL US LISTED Ex	Vaporgard™ V2L/V3L 	2 models - 100W to 200W incandescent & 50W-70W HID	1,700 - 3,300 lumens	+55°C -30°C		DLC <i>(select models)*</i>
	Emergency and Exit cUL US LISTED IECEx Ex	N2LPS, UX, Ex-Lite, Exit, Exit2 	N/A	N/A	Varies by family	✓	N/A
	Wallpack cUL US LISTED NEW!	Champ™ CPMV 	3 models - 70W to 175W HID replacement	3,400 - 6,800 lumens	+55°C -40°C		DLC <i>(pending)*</i>

† Operating temperature range may vary by lumen models within a product family. Refer to product catalog pages for complete temperature range details.

* Refer to www.designlights.org Qualified Products List under family models for full listing details. Not all models are approved for all application categories.

Crouse-Hinds series LED family selection guide

Selection guide – Hazardous areas

Area classification	Application	Product	Equivalent light output	Lumen level	Extreme ambientst†	Emergency battery option	DLC qualified
Class I, Division 1 Class II and/or Zone 1 & Zone 21	Floodlight	CEAG PXLED 	6 models - 70W to 600W HID replacement	5,000 - 30,000 lumens	+55°C -50°C		N/A
	IECEEx 						
	High/mid bay	Hazard-Gard™ EVLL/nEVLL 	5 models - 70W to 400W HID replacement	5,700 - 13,500 lumens	+65°C -25°C		 <i>(select models)*</i>
	 IECEEx						
	High/mid bay	HPLN 	8 models - 70W to 400W HID replacement	3,400 - 24,200 lumens	+55°C -40°C		N/A
	IECEEx 						
	Mid/low bay	HPL 	4 models - 70W to 175W HID replacement	3,000 - 8,000 lumens	+50°C -40°C		N/A
	IECEEx 						
	Linear	Hazard-Gard™ XPLA 	2 models - 2 lamp T5HO replacement	3,800 - 8,300 lumens	+65°C -40°C		N/A
	 						
Linear	CEAG Ex-Lin 	3 models - 2x18W, 2x36W and 2x58W fluorescent replacement	2,750 - 8,120 lumens	+55°C -40°C		N/A	
IECEEx 							
Linear	CEAG eLLK LED 	2 models - 2x18W and 2x36W fluorescent replacement	2,100 - 5,350 lumens	+55°C -25°C		N/A	
IECEEx 							
Linear	HLL 	2 models - 2x18W and 2x36W fluorescent replacement	2,800 - 5,700 lumens	+55°C -40°C		N/A	
IECEEx 							
Linear	HRL RECESSED 	3 models - 2x18W, 2x36W and 4x18W fluorescent replacement	2,700 - 5,500 lumens	+55°C -40°C		N/A	
IECEEx 							
Low bay	Hazard-Gard™ EV LED 	2 models - 100W to 200W incandescent & 70W-100W HID replacement	1,500 - 2,000 lumens	+55°C -30°C		N/A	
							
Bulkhead	AB05 LED 	1 model - 150W incandescent replacement	2,000 lumens	+55°C -55°C		N/A	
IECEEx 							

† Operating temperature range may vary by lumen models within a product family. Refer to product catalog pages for complete temperature range details.

* Refer to www.designlights.org Qualified Products List under family models for full listing details.
Not all models are approved for all application categories.

Find out which solution is right for you

Selection guide – Harsh/heavy & light industrial

Area classification	Application	Product	Equivalent light output	Lumen level	Extreme ambients†	Emergency battery option	DLC qualified
Harsh/heavy industrial	Flood 	Champ™ Pro PFMA 	11 models - 70W to 1500W HID replacement	3,300 - 50,500 lumens	+65°C -40°C		 <i>(select models)*</i>
	High/mid bay 	Champ™ Pro PVML 	9 models - 70W to 1000W HID replacement	3,250 - 26,500 lumens	+65°C -40°C		 <i>(select models)*</i>
	High/mid bay 	Champ™ Pro PVMA 	2 models - 150W to 175W HID replacement	5,800 - 7,700 lumens	+55°C -40°C		 <i>(select models)*</i>
	Mid/low bay 	PLE 	4 models - 70W to 175W HID replacement	3,000 - 8,000 lumens	+55°C -40°C		N/A
	Linear 	Champ™ Pro PLLA 	2 models - 2 lamp T5HO replacement	3,700 - 7,900 lumens	+65°C -40°C		 <i>(select models)*</i>
	Linear 	Pauluhn™ APEX 	3 models - up to 6 lamp T5HO replacement	13,000 - 25,100 lumens	+55°C -40°C		 <i>(select models)*</i>
	Linear 	Pauluhn™ Intrepid 	1 model - 2 lamp T8 replacement	3,494 lumens	+50°C -20°C		N/A
	Linear 	PLLE 	4 models - 2x18W, 2x36W and 2x58W fluorescent replacement	3,000 - 8,000 lumens	+55°C -40°C		N/A
	Linear 	CEAG LLK15 	2 models - 2x18W and 2x36W fluorescent replacement	2,100 - 4,100 lumens	+55°C -40°C		N/A
	Low bay 	Vaporgard™ Pro P2L/P3L 	2 models - 100W to 200W incandescent; 50W-70W HID	1,700 - 3,300 lumens	+55°C -30°C		 <i>(select models)*</i>
Wallpack 	Champ™ Pro WPMV 	3 models - 70W to 175W HID replacement	3,400 - 6,800 lumens	+55°C -40°C		 <i>(pending)*</i>	
Light Industrial	High bay 	Industrial high bay 	5 models - 250W-1000W HID & 4-10 Lamp T5HO replacement	16,000 - 67,000 lumens	+60°C -40°C		 <i>(select models)</i>
	High bay 	Champ® Pro PVM High Bay 	2 models - 1000W to 1500W HID replacement	60,000 - 85,000 lumens	+65°C -40°C		N/A

† Operating temperature range may vary by lumen models within a product family. Refer to product catalog pages for complete temperature range details.

* Refer to www.designlights.org Qualified Products List under family models for full listing details.

Not all models are approved for all application categories.



Champ™ FMVA LED floodlights

PRIMARY APPLICATIONS

Indoor and outdoor area lighting in manufacturing plants, heavy industrial chemical and petrochemical facilities, platforms, loading docks and parking lots.

LUMINAIRE MODELS

Model number	Equivalent HID luminaire	Typical energy savings/lifetime
FMVA3L	70W	Up to 78% reduction in energy costs and 60,000 hours of continuous operation!
FMVA5L	100W	
FMVA7L	175W	
FMVA9L	250W	
FMVA11L	320W	
FMVA13L	400W	
FMVA15L	500W	
FMVA20L	600W-750W	
FMVA25L	705W-1000W	
FMVA40L	1,500W+	
FMVA50L	1,500W+	

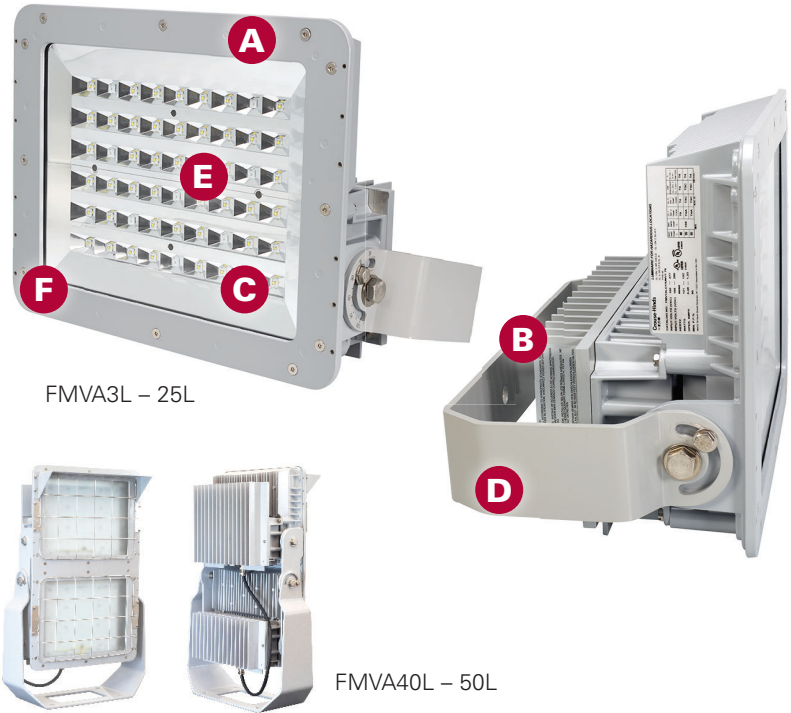

CERTIFICATIONS & COMPLIANCES

- Class I, Division 2, Groups A, B, C, D
- Class I, Zone 2
- Class II, Division 1, Groups E, F, G; Simultaneous Presence; Class III
- Type 4X, IP66
- UL844; UL1598; UL1598A; UL8750
- CSA C22.2 No. 137
- IECEx/ATEX Certified; Zone 2/22
- CE
- DesignLights Consortium® approved for select models*



ELECTRICAL RATINGS

- Voltages: 100-277 VAC/108-250 VDC, 347-480 VAC
- Input power: 28W, 45W, 62W, 79W, 99W, 112W, 131W, 175W, 216W, 340W, 411W

OPTIONS AND ACCESSORIES

- Bolt-on visor; bolt-on wire guard
- Floodlight slipfitter (not available for 40L & 50L)
- Slipfitter wall mount adapter (not available for 40L & 50L)
- Diffused glass lens
- Dimmable driver
- 3x3 optic (select models)

Up to 6 times longer life and 78% reduction in power consumption compared to equivalent HID floodlights

DESIGN FEATURES

- A Versatile design** - Can be used for outdoor or indoor applications, and for a wide range of mounting heights depending on model and light level requirement.
- B Rugged heat sink** - Designed to perform in high ambient temperatures up to +65°C and as low as -40°C. The thick walls of the castings make for a tough, rugged housing that keeps the internal driver and LED temperatures down.
- C High lumen output** - Up to 120 lumens per watt.
- D Full-frame yoke** - Designed to utilize the SFA6 slipfitter and SWB6 wall mount bracket, making it ideal for retrofit or new installations (not available for 40L & 50L).
- E Multiple lens options** - Tempered and clear glass standard, polycarbonate and diffused glass options available.
- F Smaller and lighter** - 25% smaller and 10 lbs (4.5 kg) lighter than previous model (3L-25L models).



† Operating temperature range may vary by lumen models within a product family. Refer to product catalog pages for complete temperature range details.

* Refer to www.designlights.org Qualified Products List under family models for full listing details. Not all models are approved for all application categories.

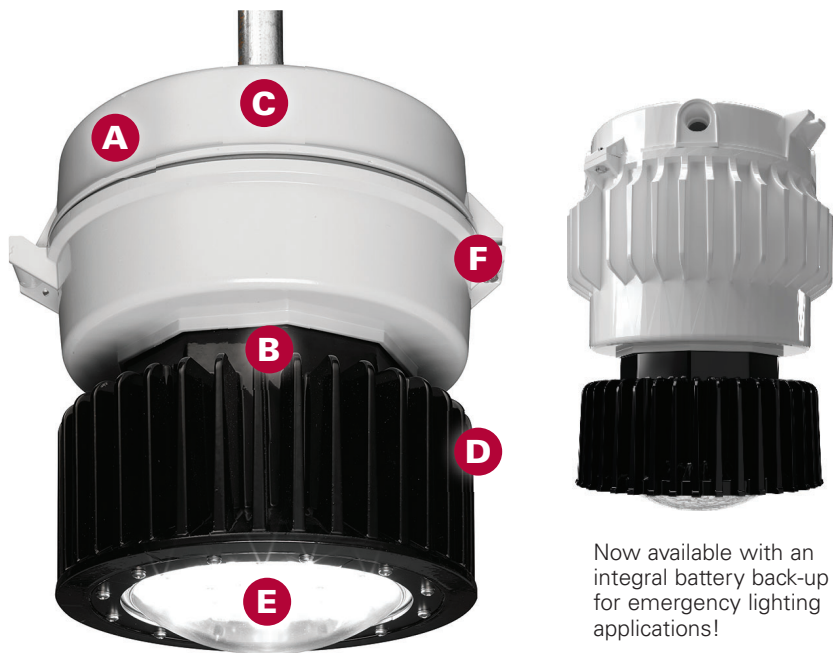

VMVL-3 – VMVL-11

Now available with an integral battery back-up for emergency lighting applications!

Custom Type I, III and V optics for better output, zero maintenance and reduced energy consumption

DESIGN FEATURES

- A Modular design** - This contractor-friendly design is ideal for both retrofit and new construction applications.
- B Safe, reliable heat transfer** - Die cast aluminum housing provides safe and effective heat transfer from the LED assembly to the outside environment, ensuring low LED junction temperature, reliability and sustained lumen performance.
- C High efficiency drivers** - Designed to provide reliable operation in even the harshest environments.
- D Type 4X rated** - The LED housing is constructed of durable die cast aluminum, providing an efficient thermal path to the heat sink assembly. The impact-resistant lens is sealed from the outside environment and provides ingress protection against water and dust.
- E Custom optics** - Type I, III and V optics designed to maximize light distribution and intensity.
- F Lever-lock connectors and 3-pole terminal block.**



† Operating temperature range may vary by lumen models within a product family. Refer to product catalog pages for complete temperature range details.

* Refer to www.designlights.org Qualified Products List under family models for full listing details. Not all models are approved for all application categories.

Champ™ VMVL LED luminaires

PRIMARY APPLICATIONS

Locations requiring continuous and consistent light levels in extreme ambient temperatures, such as manufacturing plants, heavy industrial or petrochemical facilities, food and beverage facilities, platforms, loading docks, tunnels, outdoor wall and stanchion mounted general area lighting.

LUMINAIRE MODELS

Model number	Equivalent HID luminaire	Typical energy savings/lifetime
VMVL-3	70W	Up to 77% reduction in energy costs and 60,000 hours of continuous operation!
VMVL-5	100W	
VMVL-7	175W	
VMVL-9	250W	
VMVL-11	320W	
VMVL-13	400W	
VMVL-17	400W-600W	
VMVL-21	600W-750W	
VMVL-25	750W-1000W	

CERTIFICATIONS & COMPLIANCES

- Class I, Division 2, Groups A, B, C, D
- Class I, Zone 2 nA; Zone 21 tb
- Class II, Division 1, Groups E, F, G; Class III
- Simultaneous presence
- UL844; UL1598; UL1598A; UL8750; UL50; UL50E
- cUL Listed to CSA C22.2 No. 137
- NEMA 4X, IP66, Wet Locations
- IECEx/ATEX Certified; Zone 2/21
- DesignLights Consortium® approved for select models*
- CE



ELECTRICAL RATINGS

- Voltages: 120-277 VAC/ 108-250 VDC, 347/480 VAC
- Input power: 29W, 41W, 54W, 74W, 89W, 130W, 168W, 196W, 232W

OPTIONS AND ACCESSORIES

- Integral back-up battery (90 minutes of emergency lighting)
- Quick clip to simplify installation
- Diffused lens, teflon coated lens, and polycarbonate lens
- Wire guard
- Trunnion mount
- Cone top hat
- Type I, III and V optics
- Terminal block (TB6) 6-pole

Champ™ VMV LED Connected fixtures

PRIMARY APPLICATIONS

Indoor and outdoor area lighting in manufacturing plants, heavy industrial chemical and petrochemical facilities, platforms, loading docks and parking lots.

LUMINAIRE MODELS

Model number	Equivalent HID luminaire	Typical energy savings/lifetime
VMV3L	70W-100W	
VMV5L	100W-150W	Up to 77% more efficient than standard LED light fixtures!
VMV7L	150W-175W	
VMV9L	250W-320W	
VMV11L	320W-400W	

CERTIFICATIONS & COMPLIANCES

- Class I, Division 2, Groups A, B, C, D
- Class I, Zone 2, nA nR
- Class II, Division 1, Groups E, F, G; Simultaneous Presence; Class III
- Zone 21 tb
- Type 4X, IP66, Wet Locations, Marine Listed
- UL1598; UL1598A; UL8750; UL844; UL60079-0; UL60079-11; UL60079-15; UL60730; UL913; UL50; UL50E
- NEC NFPA 70
- R/C for sensor and controller
- cUL Listed to CSA Standard C22.2 No. 250 (for Luminaires)
- cUL Listed to CSA Standard C22.2 No. 137 (Electric Luminaires for Hazardous Locations)
- CSA 60079-11
- CSA 60079-0
- CE (pending)
- ATEX/IECEx nA, nR, ia (pending)
- DLC (pending)

ELECTRICAL RATINGS

- Voltages: 100-277 VAC; 108-250 VDC
- Input power: 29W, 41W, 54W, 74W, 89W

OPTIONS AND ACCESSORIES

- Pendant, cone pendant, ceiling, wall, and stanchion mounts
- Trunnion mount kit
- Safety cable
- Diffused lens; Teflon coated lens; Polycarbonate lens
- Terminal block (TB6) 6-pole

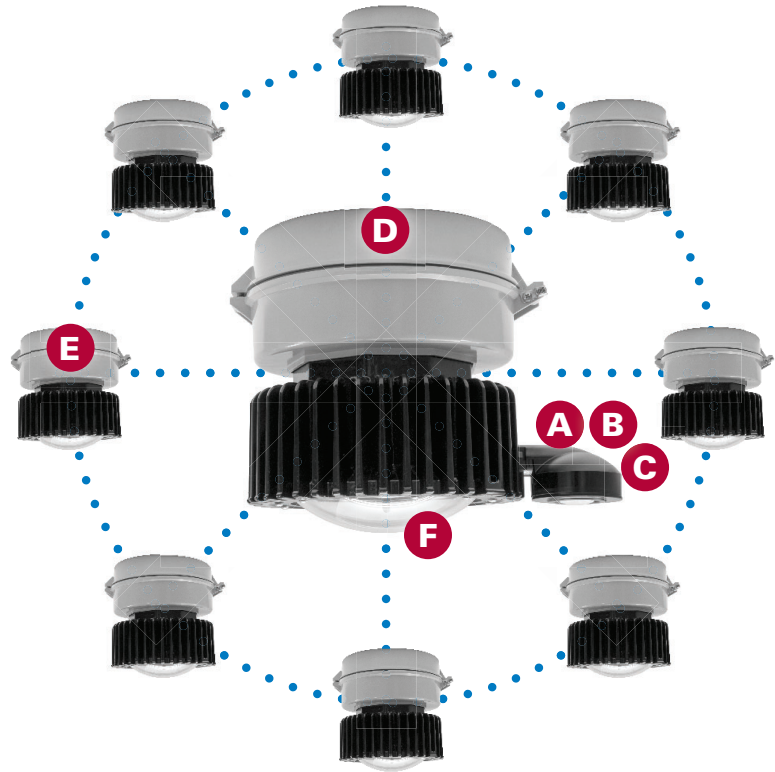

Full lighting control at your fingertips, allowing you to maximize energy savings and minimize maintenance costs

DESIGN FEATURES

- A Integral sensor** - Detects and measures area occupancy, lighting levels and ambient temperatures. Up to 40 ft. sensor range provides excellent coverage.
- B Occupancy sensing** - Motion sensing to monitor occupancy of a site or for control of infrequently used areas.
- C Daylight harvesting** - Photo sensing measures ambient light levels and adjusts light output accordingly, saving energy and extending fixture life.
- D Scheduled ON/OFF and Dimming** - Management of time scheduling to optimize energy usage installations.
- E Fixture grouping** - Tempered and clear glass standard, polycarbonate and diffused glass options available.
- F Integral controller** - Send commands to multiple fixtures to control lighting levels per predefined settings. Also communicates system notifications/alarms on the fixture, sensor and radio.



† Operating temperature range may vary by lumen models within a product family. Refer to product catalog pages for complete temperature range details.

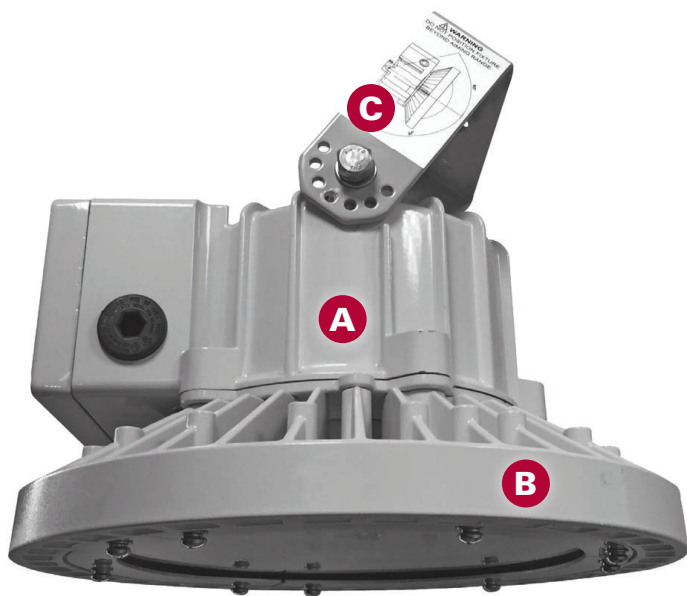

Low profile and lightweight design, easy to install and reliable illumination in Zone 2 and 22 areas

DESIGN FEATURES

- A Rugged design** - Highly durable aluminum housing with a tempered and impact resistant glass globe. NLE fixture has an operating temperature range of -40°C to +55°C.
- B Lightweight and compact** - Low profile and lightweight design is ideal for compact installations.
- C Ease of installation** - U-shaped yoke mount provides mounting flexibility - wall, ceiling, pole, etc.



† Operating temperature range may vary by lumen models within a product family. Refer to product catalog pages for complete temperature range details.

NLE LED light fixtures

PRIMARY APPLICATIONS

Certified for Zone 2 and Zone 22 hazardous areas. Suitable for mid bay and low bay lighting applications in chemical, petrochemical, pharmaceutical, platforms, shipyards, loading docks, wastewater treatment and paper mills.

LUMINAIRE MODELS

Model number	Equivalent HID luminaire	Typical energy savings/lifetime
NLE-3L	70W-100W	
NLE-5L	100W-150W	Up to 66% reduction in energy costs
NLE-7L	150W-175W	
NLE-8L	150W-175W	

CERTIFICATIONS & COMPLIANCES

- Ex nR IIC T6/T5 Gc
- Ex tb IIIC T80°C/T100°C Db
- Ex tD A21 IP66 T80°C/T100°C
- EN 55015:2013
- EN 61000-6-4:2007/A1:2011
- EN 61000-3-2:2006/A2:2009
- EN 61000-3-3:2013
- EN 61547:2009
- EN 61000-6-2:2005/AC:2005
- IEC 61000-4-2 ed2.0(2008-12);IEC 61000-4-3 ed3.2 Consol.with am 1&2(2010-04)
- IEC 61000-4-4 ed3.0(2012-04);IEC 61000-4-5 ed2.0 (2005-11);IEC 61000-4-6 ed4.0(2013-10)
- IEC 61000-4-8 ed2.0(2009-09);IEC 61000-4-11 ed2.0 (2004-03)
- IP66

ELECTRICAL RATINGS

- Voltages: 100-240 VAC; 108-250 VDC
- Input power: 30W, 50W, 70W, 80W

OPTIONS AND ACCESSORIES

- Clear or diffused glass lens
- Warm white (3000K) and cool white (5700K) color temperatures

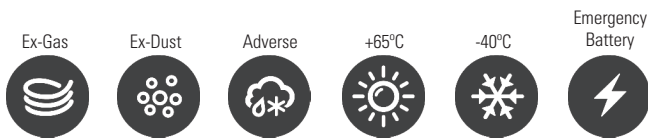

Champ™ MLLA linear LED light fixtures

PRIMARY APPLICATIONS

Oil and gas refineries, petrochemical facilities, food and beverage facilities, platforms, loading docks, tunnels outdoor and stanchion mounted general area lighting, and where flammable vapors, gases, ignitable dusts, fibers or flyings are present.

LUMINAIRE MODELS

Model number	Equivalent fluorescent luminaire	Typical energy savings/lifetime
MLLA2	2 x 2 ft. T5/T8/T12HO	Up to 67% reduction in energy costs and 60,000 hours of continuous operation!
MLLA4	2 x 4 ft. T5/T8/T12HO	Up to 67% reduction in energy costs and 60,000 hours of continuous operation!

CERTIFICATIONS & COMPLIANCES

- Class I, Division 2, Groups A, B, C, D
- Class I, Zone 2
- Class II, Division 1, Groups F, G
- UL844; UL1598; UL1598A; UL924
- CSA C22.2 No. 137
- NEMA 4X, IP66, Marine and Wet Locations
- DesignLights Consortium® approved for select models*
- ABS design assessed



ELECTRICAL RATINGS

- Voltage: 100-277 VAC, 347-480 VAC, 108-250 VDC
- Input power: 29W, 55W

OPTIONS AND ACCESSORIES

- Available with a self-contained battery system for emergency lighting applications
- Diffused glass or polycarbonate lens
- Flush/back, ceiling/swivel, wall, offset wall, pole and pendant mounts
- Safety chain kit
- Epoxy painted or natural aluminum finish

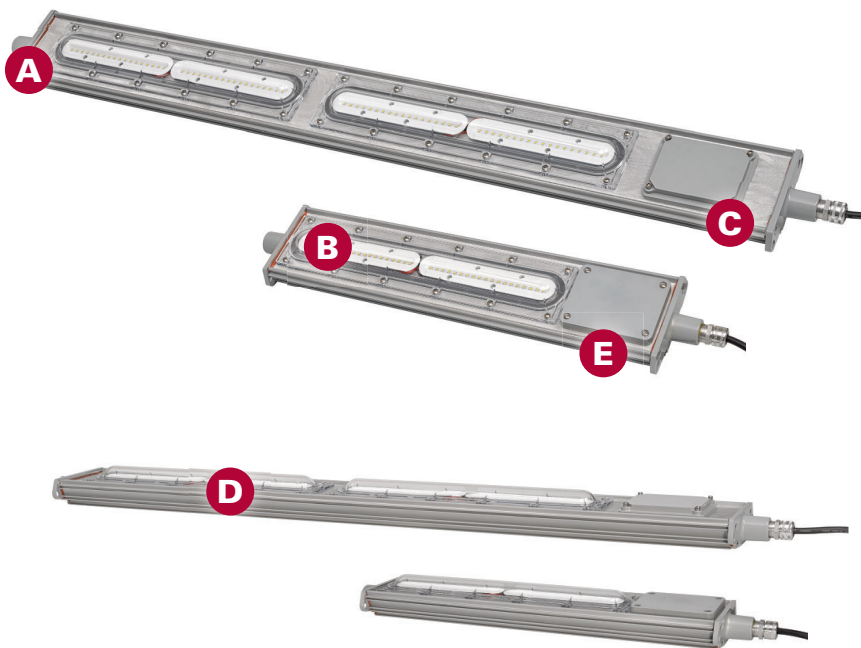

Up to 67% more energy efficient than a T5HO fluorescent light and 8 times the rated life

DESIGN FEATURES

- A Best-in-class efficacy** - Up to 130 lumens per watt.
- B Custom optics** - Standard wide (120°) and narrow (80°) beam pattern for a wide variety of general and targeted applications.
- C Built to last** - Passed 2,000 psi high pressure hose test; passed 5G vibration test; 60,000 hour lifetime @ 55°C ambient.
- D Slim profile** - 2.7" fixture height (excluding mounting brackets), perfect for mounting in confined or low height areas.
- E Quick & easy installation** - Easy access to drivers and wiring; no custom brackets or hardware needed; Seven mounting options available.



† Operating temperature range may vary by lumen models within a product family. Refer to product catalog pages for complete temperature range details.

* Refer to www.designlights.org Qualified Products List under family models for full listing details. Not all models are approved for all application categories.

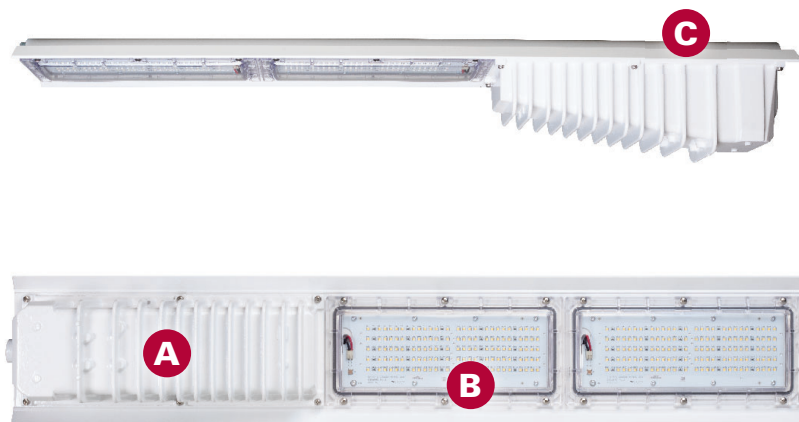

NSF Splash Zone rated, 1500 PSI hose down tested and an angled housing to mitigate debris build-up

DESIGN FEATURES

- A Innovative and robust design** - Angled light fixture mitigates debris build-up. Withstands 1500 psi high pressure wash down, and food rated paint maintains safety.
- B High performance optics and drivers** - 100+ lumens per watt provides highly efficient lighting. Rated life is up to 60,000 hours of maintenance-free and safe operation.
- C Easily customized for application-specific performance** - Versatile mounting options with a through feed design for simplified multiple fixture wiring.



† Operating temperature range may vary by lumen models within a product family. Refer to product catalog pages for complete temperature range details.

Pauluhn™ Summit LED linear light fixtures

PRIMARY APPLICATIONS

Replaces fluorescent T12, T8, and T5HO fixtures in hazardous rated food processing, hose down and corrosive environments.

The Summit LED was designed with food and beverage processing facilities in mind. The fixture housing is angled to mitigate debris build-up and features a food-rated epoxy powder coat finish. Plus, its robust design can withstand 1,500 PSI hose pressure for wash down applications.

LUMINAIRE MODELS

Model number	Equivalent luminaire	Typical energy savings/lifetime
SUM13L	3 lamp T5HO	Up to 50% reduction in energy costs and minimum 60,000 hours of continuous operation!
SUM17L	4 lamp T5HO	
SUM25L	6 lamp T5HO	

CERTIFICATIONS & COMPLIANCES

- Class I, Division 2, Groups A, B, C, D
- Class II, Division 1, Groups E, F, G
- UL1598; UL8750, UL844
- CSA 22.2 No. 137
- NSF Splash Zone
- Type 4X; IP66

ELECTRICAL RATINGS

- Voltages: 100-277 VAC/347-480 VAC, 127-250 VDC
- Input power: 122W, 144W, 217W

OPTIONS AND ACCESSORIES

- Polycarbonate lens in clear or diffused
- 0-10V dimming capabilities
- Surface/swivel mount, cable/chain mount and threaded rod mount
- Available with cord assemblies and quick disconnect receptacle



CEAG™ nLLK15 LED linear light fixtures

PRIMARY APPLICATIONS

Long-life LED tubes provide general illumination, indoors or out, in Zone 2 and 22 hazardous environments around the globe. Heavy duty, non-metallic construction stands up to tough physical and environmental demands, making it an excellent choice where dust, dirt, gas, vapor, smoke, fumes, moisture, corrosive and wet conditions are present.

LUMINAIRE MODELS

Model number	Equivalent fluorescent luminaire	Typical energy savings/lifetime
nLLK15 LED 600	2 x 18W	Up to 77% more efficient than standard LED light fixtures!
nLLK15 LED 1200	2 x 36W	
nLLK15 LED 1500	2 x 58W	

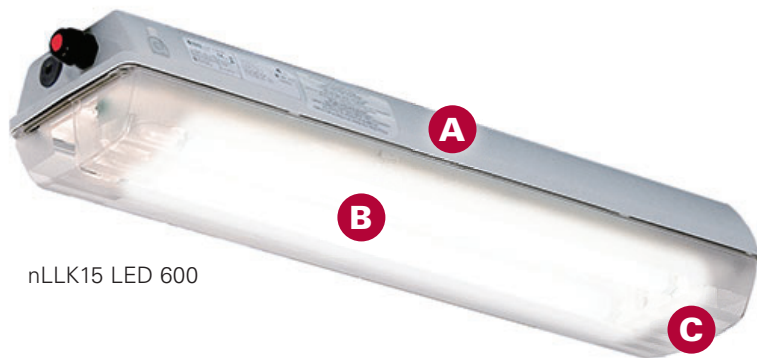

nLLK15 LED 600



nLLK15 LED 1200 and 1500

CERTIFICATIONS & COMPLIANCES

Marking accd.to 2014/34/EU:

- Ex II 3 G Ex ec IICT4 Gc
- Ex II 3 D Ex tc IICT80°C Dc
- EC-Declaration of Conformity: CCH 15 ATEX 1044
- IP66

ELECTRICAL RATINGS

- Voltage: 220-240 VAC/DC
- Input power: 18W, 37W, 49W

OPTIONS AND ACCESSORIES

- Available with safety switch on request
- Self-contained battery version available
- Connection to CEAG emergency light monitoring systems possible (V-CG-S)
- Light controlling via DALI interface (DALI option)

Crisp, bright light and durability in harsh environments provides a long-life solution in Zone 2 and 22 areas

DESIGN FEATURES

- A Built to last** - Heavy duty, non-metallic construction stands up to tough physical and environmental demands, making it an excellent choice where dust, dirt, gas, vapor, smoke, fumes, moisture, corrosive and wet conditions are present.
- B High output** - Utilizes Aura UltiLED LED tubes for extreme applications, providing high efficacy and long life.
- C Emergency** - Available with a self-contained battery system or V-CG-S module for monitoring with an Eaton central battery system.



† Operating temperature range may vary by lumen models within a product family. Refer to product catalog pages for complete temperature range details.

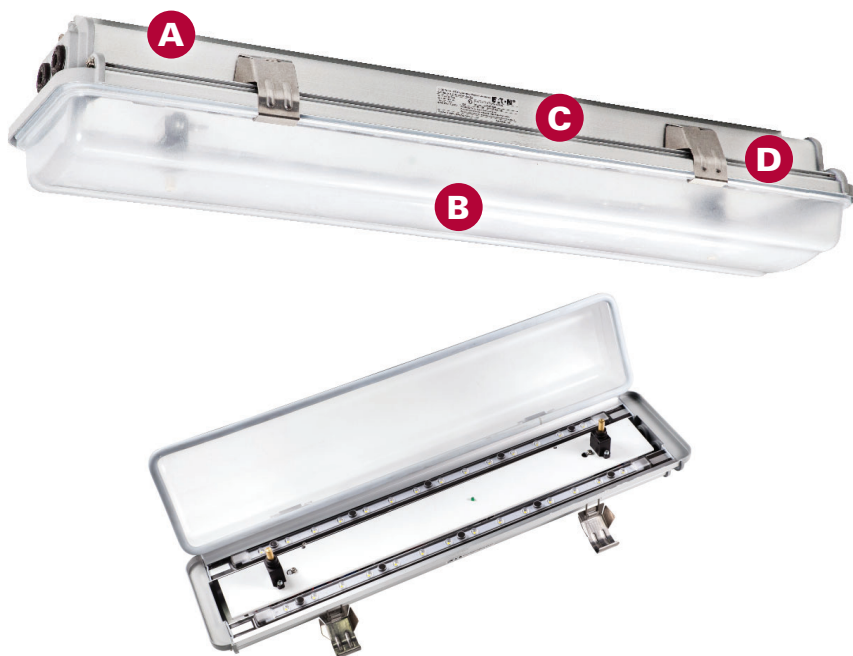
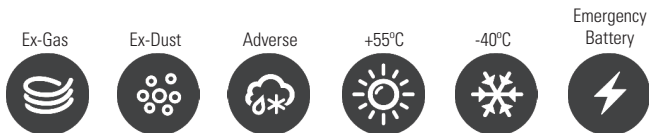

Rugged, low profile fixture that is easy to install and provides clear illumination in Zone 2 and 22 hazardous areas

DESIGN FEATURES

- A Rugged design** - Copper-free aluminum housing and impact-resistant polycarbonate lens provide excellent resistance to corrosion and heat.
- B Easy installation** - Lightweight design, hinged cover, and a terminal block wing for easy installation and maintenance.
- C Industry leading thermal management** - For safe and reliable operation over a wide temperature range.
- D Retrofit friendly** - Fixture utilizes the same mounting footprint of linear fluorescent lighting.



† Operating temperature range may vary by lumen models within a product family. Refer to product catalog pages for complete temperature range details.

nHLL LED linear light fixtures

PRIMARY APPLICATIONS

Constructed with an aluminum housing and high impact-resistant polycarbonate cover for use in Zone 2 and 22 hazardous areas where moisture or corrosion may be a problem, such as offshore oil platforms, pharmaceutical and chemical plants, oil refineries and industrial locations.

LUMINAIRE MODELS

Model number	Equivalent luminaire	Typical energy savings/lifetime
NHLL-2-C2-3L	2x18W	Up to 39% reduction in energy costs and 50,000 hours of continuous operation!
NHLL-2-C2-4L	2x36W	
NHLL-4-C2-5L	2x36W	
NHLL-4-C2-8L	2x58W	

CERTIFICATIONS & COMPLIANCES

- Ex db ec IIC T5/T6 Gc
- Ex ec IIC T5/T6 Gc
- Ex db ec ib mb IIC T5/T6 Gc
- Ex ec ib mb IIC T5/T6 Gc
- Ex tb IIIC T80°C Db
- IECEx-certification of conformity: IECEx NEP 18.0003X
- EC-Type examination certificate: SEV 18 ATEX 0171X
- IP66

ELECTRICAL RATINGS

- Voltages: 100-240 VAC
- Input power: 30W, 40W, 60W, 80W

OPTIONS AND ACCESSORIES

- Epoxy coating on aluminum housing
- Emergency battery back-up
- Pipe, wall, and ceiling mounts available

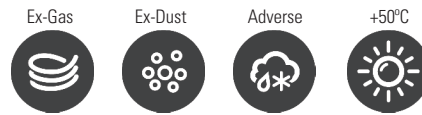

Vaporgard™ V2L/V3L LED luminaires

PRIMARY APPLICATIONS

Indoor or outdoor areas with low mounting heights or confined spaces, such as tunnels and catwalks, over doorways or entries, landing areas, utility rooms, etc.

LUMINAIRE MODEL

Model number	Equivalent luminaire	Typical energy savings/lifetime
V2LM2	50W HID or 150-200W incandescent	Up to 85% reduction in energy costs and 50,000 hours of continuous operation!
V3LM2		

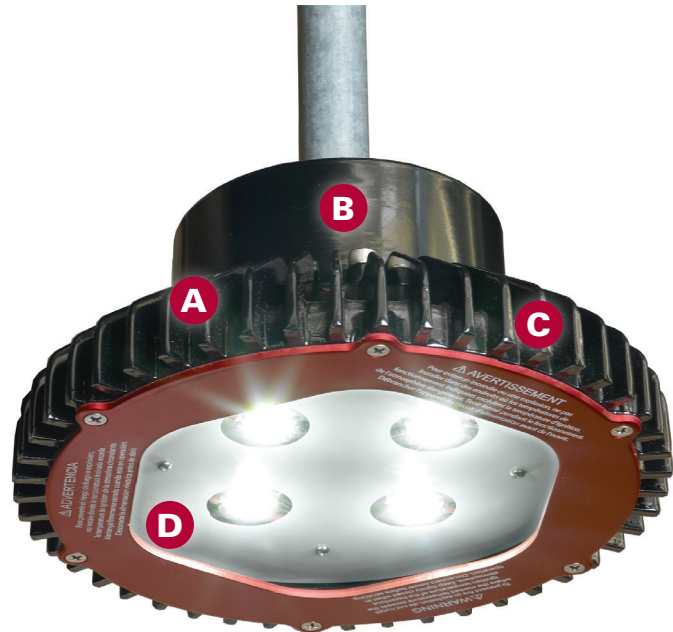

CERTIFICATIONS & COMPLIANCES

- Class I, Division 2, Groups A, B, C, D
- Class II, Division 1, Groups F, G
- UL844; UL1598; UL1598A
- CSA C22.2 No. 137
- NEMA 4X
- UL1598; UL1598A
- IP66
- RoHS Compliant
- ATEX/IECEX Zone2/22
- DesignLights Consortium® approved for select models*



ELECTRICAL RATINGS

- Voltages: 120-277 VAC, 12-24 VDC
- Input power: 14W, 29W

OPTIONS AND ACCESSORIES

- Frosted lens
- Teflon coated lens
- Brazil (CEPEL) Certification
- Color temperature: Warm white (3000K)
- 12-24 VDC Driver

85% more energy-efficient than a 200 watt incandescent and over 20 times the rated life

DESIGN FEATURES

- A Domeless reflector, low profile design** - Designed for low mounting heights and confined spaces where incandescent and HID based luminaires are too large.
- B Installation and replacement made simple** - Installed using the same mounting modules as existing Eaton's Crouse-Hinds Vaporgard™ fixtures.
- C Safe, reliable heat transfer** - Heat sink engineered to safely and effectively remove heat from the LED and driver, ensuring long product life and superior T-ratings.
- D High power multi-die LED arrays** - Provides instant on and full illumination in the harshest conditions, even when exposed to high, repeated vibration.



† Operating temperature range may vary by lumen models within a product family. Refer to product catalog pages for complete temperature range details.

* Refer to www.designlights.org Qualified Products List under family models for full listing details. Not all models are approved for all application categories.

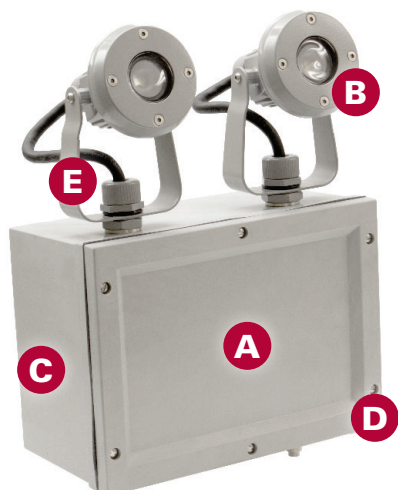
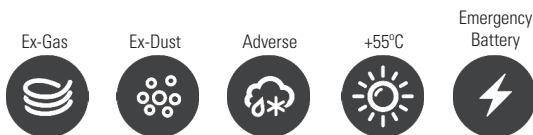

Our N2LPS M2 is smaller, lighter and more energy efficient than the previous model!



LED egress, emergency and exit lighting designed for harsh and hazardous locations

N2LPS M2 DESIGN FEATURES

- A Non-metallic, enclosed, gasketed housing** - Provides corrosion protection in the most extreme environments.
- B Durable and marine rated LED lamp head assemblies** - Provide protection against water ingress, corrosion and impact.
- C Nickel cadmium battery** - High temperature rated nickel cadmium battery for reliable operation up to 55°C ambient.
- D Reduced maintenance costs** - Self-test, monitoring and diagnostics reduce costly maintenance checks.
- E Remote mountable lamp heads** - Lamp heads can be mounted independently from the enclosure, allowing you to focus light where you need it.

Exit Lighting DESIGN FEATURES

- F Corrosion- and impact-resistant housing** - Ensures long product life and reliability.
- G Nickel cadmium battery** - Premium heavy duty nickel cadmium battery with 24-hour charge and recharge time increases safety by recovering quickly from an outage.
- H Multiple "EXIT" legend options** - EXIT inscriptions, pictograms, and directional arrows to meet customer preferences.



* Zone ratings vary by product family. Refer to individual catalog pages for complete certifications and compliances.

† Operating temperature range may vary by lumen models within a product family. Refer to product catalog pages for complete temperature range details.

LED emergency and exit lights

N2LPS M2 Emergency Lighting PRIMARY APPLICATIONS

Used to provide reliable illumination for egress areas during failure or interruption of power to the normal lighting system.

LUMINAIRE MODEL

Model number	Battery life
N2LPSM2	90 minutes

CERTIFICATIONS & COMPLIANCES

- Class I, Division 2, Groups B, C, D
- Class I, Zone 2
- UL844; UL924; UL1598A
- CSA C22.2 No. 141-M1985; C22.2 No. 137-M1981
- Life Safety Code NFPA101® - Section 5-9
- Type 4X, Marine Wet Locations

ELECTRICAL RATINGS

- Power supply input: 102-277VAC; 6W max.
- LED heads: 12VDC, 1W LED, 6W max.

LED Exit Signs

PRIMARY APPLICATIONS

Used for marking escape routes and exits in potentially explosive atmospheres.

LUMINAIRE MODELS

Model Number	Rating	Battery
Ex-Lite	Hazardous	Optional
UX LED	Industrial or Hazardous	Optional
EXIT / EXIT 2	Hazardous	Optional

CERTIFICATIONS & COMPLIANCES

Ex-Lite:

- Class I, Division 2, Groups A, B, C, D
- Class I, Zone 1
- Class II, Division 2, Groups F, G (NEC)
- IP66
- UL844; UL924; UL60079; UL1203

UX LED:

- Class I, Division 2, Groups A, B, C, D
- NEMA 4X, IP66, Outdoor Wet Locations
- UL50; UL844; UL924; UL1598A

EXIT / EXIT 2

- Ex e ib mb IIC T6/T5 Gb; Ex tb IIIC T80°C Db
- IECEx BVS 13.0017
- EC-Type Examination Certificate: BVS 09 ATEX E 029

ELECTRICAL RATINGS

- Please refer to individual catalog pages



Champ™ CPMV LED wallpack light fixtures

PRIMARY APPLICATIONS

Provides a low profile solution for hazardous lighting applications. It's the ideal choice for vertical surface lighting where harsh and hazardous conditions require high quality, reliable illumination.

LUMINAIRE MODELS

Model number	Equivalent HID luminaire	Typical energy savings/lifetime
CPMV3L	70W	Up to 70% reduction in energy costs and 60,000 hours of continuous operation!
CPMV5L	100W	
CPMV7L	150W-175W	

CERTIFICATIONS & COMPLIANCES

- Class I, Division 2, Groups A, B, C, D
- Class II, Division 1, Groups E, F, G
- UL844; UL1598; UL1598A; UL8750
- CSA C22.2 No. 137
- NEMA 4X, IP66, Marine and Wet Locations
- DesignLights Consortium® pending*



ELECTRICAL RATINGS

- Voltage: 100-277 VAC, 347-480 VAC, 125/250 VDC
- Input power: 30W, 45W, 59W

OPTIONS AND ACCESSORIES

- Available with a variety of lens types, including clear glass, diffused glass, clear polycarbonate and diffused polycarbonate
- Yoke mount and hub mount options are available
- Available with a photocell

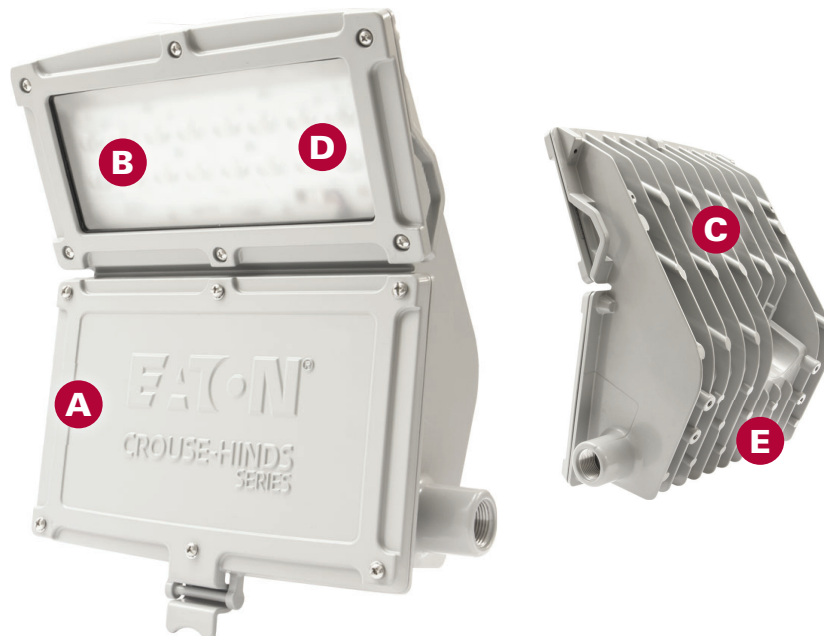

Low profile, long life and high performance in Class I, Division 2 and Class II, Division 1 areas.

DESIGN FEATURES

- A Built to last** - Rated for 60,000+ hours of operation at 55°C. Impact-resistant lens sealed from the outside environment provides ingress protection against water and dust
- B High efficiency** - Up to 116 lumens per watt
- C Rugged Design** - Engineered to perform in ambient temperatures from -40°C to +55°C. Die cast aluminum LED housing provides efficient thermal path to heat sink assembly, and vertical fin design facilitates air flow and dust shedding.
- D Multiple optic and lens options** - Narrow and wide optics for ideal light output. Four lens styles provide flexibility for specific applications and customer preferences
- E Simple installation** - Contractor-friendly design is ideal for both retrofit and new construction. Available with lever lock connectors



† Operating temperature range may vary by lumen models within a product family. Refer to product catalog pages for complete temperature range details.

* Refer to www.designlights.org Qualified Products List under family models for full listing details. Not all models are approved for all application categories.



LED vs. Conventional lighting technologies

Why are so many facilities making the switch to Crouse-Hinds series LED?

The numbers say it all.

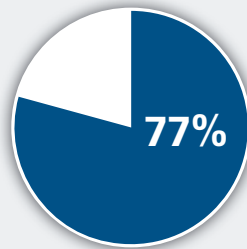

AVERAGE REDUCTION IN ENERGY COSTS



MAINTENANCE REDUCTION

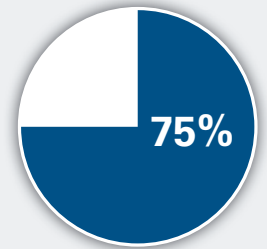

75% LOWER TOTAL COST OF OWNERSHIP

Assumptions: Calculations based on overall life of the LED system. Energy cost of \$.09 per kilowatt; 24 hour per day operation; labor rate of \$75 each for 2 workers; average time for fixture maintenance of 1 hour.



CEAG™ PX LED Floodlights

PRIMARY APPLICATIONS

Ideal for ceiling and wall mounted general area lighting where flammable vapors and gases are present, along with harsh conditions including vibration, dust, moisture, corrosive atmospheres and extreme temperatures

LUMINAIRE MODELS

Model number	Equivalent HID luminaire	Typical energy savings/lifetime
PXLED5L	100W-150W	Up to 70% reduction in energy costs and 60,000 hours of continuous operation!
PXLED10L	175W-250W	
PXLED15L	400W-500W	
PXLED20L	600W-750W	
PXLED25L	750W-1000W	
PXLED30L	1500W	



CERTIFICATIONS & COMPLIANCES

Marking accd.to IECEx:

- Ex db eb op is q IIC T4 Gb
- Ex tb op is IIIC T100°C Db

Marking accd.to 2014/34/EU:

- Ex II 2 G Ex db eb op is q IIC T4 Gb
- Ex II 2 D Ex tb op is IIIC T100°C Db
- BVS 17 ATEX E 013 X
- IECEx Certificate of conformity: IECEx BVS 17.0004 X
- IP66/67

ELECTRICAL RATINGS

- Voltages: 110-277 VAC; 127-270 VDC
24-48VDC available for PXLED 5L
- Input power: 49W, 98W, 147W, 196W, 245W, 294W

OPTIONS AND ACCESSORIES

- Wide, narrow and asymmetric beam options
- Pole mounting

60,000 hour rated life at 55°C ensures years of reliable performance in hazardous IEC applications

DESIGN FEATURES

- A Modular design** - Provides six models with light output ranging from 5,000 lumens up to 32,000 lumens.
- B High efficiency LEDs** - Delivers up to 110 lm/W, reducing energy costs by up to 70% over conventional lamps.
- C Easy installation and maintenance** - Ex-e compartment provides quick access to the driver and terminals.
- D Simple, flexible alignment** - Stainless steel swivel bracket with adjustable setting angle allows an easy alignment of the floodlight.
- E Custom optics** - Wide and narrow beam pattern options distribute light where you need it most.
- F Built to last** - Designed for offshore and high vibration applications.



† Operating temperature range may vary by lumen models within a product family. Refer to product catalog pages for complete temperature range details.



**Energy-efficient and globally certified
explosionproof workhorse for general area
and high bay lighting applications**

DESIGN FEATURES

- A Retrofittable to install base** - Adapter available for connection to existing Hazard•Gard® EVI, EVLP and EVM modules.
- B Quick-connect design** - Install and wire the mounting module, then simply screw in the luminaire.
- C Factory sealed** - No external sealing fittings required in Groups B, C and D.
- D 60,000 hours rated life** - Eliminates the need for frequent lamp replacement.
- E Shock- and vibration-resistant** - The LED housing is constructed of durable die cast aluminum, providing efficient long life.



† Operating temperature range may vary by lumen models within a product family. Refer to product catalog pages for complete temperature range details.

Hazard-Gard™ EVLL LED luminaires

PRIMARY APPLICATIONS

Used for general lighting in areas where flammable or explosive vapors or gases are present, such as petroleum refineries, chemical and petrochemical plants, oil terminals, gas plants, drilling platforms and wastewater treatment plants.

LUMINAIRE MODELS

Model number	Equivalent HID luminaire	Typical energy savings/lifetime
EVLL5L	100W-150W	Up to 62% reduction in energy costs and 60,000 hours of continuous operation!
EVLL7L	150W-175W	
EVLL9L	175W-250W	
EVLL11L	250W-320W	
EVLL13L	320W-400W	

CERTIFICATIONS & COMPLIANCES

- Class I, Division 1, Groups B, C, D
- Class I, Zone 1, Groups IIB + H₂, IIB, IIA
- Class II, Groups E, F, G
- Class III, Simultaneous Presence
- UL844; UL1598; UL1598A
- CSA C22.2 No. 137
- NEMA 4X, IP66, Wet Locations
- CE
- ATEX/IECEX, Zone 1/21

ELECTRICAL RATINGS

- Voltages: 120-277 VAC/108-250 VDC, 347-480 VAC
- Input power: 56W, 85W, 112W, 115W, 149W

OPTIONS AND ACCESSORIES

- Trunnion mount
- Guard
- Color temperature: warm (3000K) or cool (5000K)
- Pendant, ceiling, stanchion and wall mounts
- Epoxy painted



HPLN LED light fixtures

PRIMARY APPLICATIONS

Suitable for Zone 1 and Zone 2 Ex-Gas and Zone 21/22 Ex-Dust hazardous areas, such as heavy industrial, chemical, petrochemical or pharmaceutical facilities, platforms, shipyards, electric power, loading docks, wastewater treatment plants and paper mills.

LUMINAIRE MODELS

Model Number	Equivalent HID Luminaire	Typical Energy Savings/ Lifetime
HPLN-3L	70W-100W	Up to 60% reduction in energy costs
HPLN-5L	100W-150W	
HPLN-7L	150W-175W	
HPLN-9L	175W-250W	
HPLN-11L	250W-450W	
HPLN-15L	400W	
HPLN-21L	600W	
HPLN-25L	600W-1000W	



A long-life, energy-efficient luminaire for general area lighting in hazardous IEC applications

CERTIFICATIONS & COMPLIANCES

Marking accd.to IECEx:

- Ex db eb mb op is IIC T4 Gb
- Ex tb op is IIIC T95°C Db

Marking accd.to 2014/34/EU:

- II 2 G Ex db eb mb op is IIC T4 Gb
- II 2 D Ex tb op is IIIC T95°C Db

Certificate No.

- IECEx PRE 19.0058X
- Presafe 19 ATEX 09286X

Permissible ambient temperature

- -40°C up to +55°C

Degree of protection accd. to EN60529

- IP66

ELECTRICAL RATINGS

- Voltage: 100-240 VAC 50/60Hz; 120-250 VDC

OPTIONS AND ACCESSORIES

- Cool white (5,700K) and warm white (3,000K) are available
- Frosted lens reduces glare on critical processes
- Mounting: Pendant, ceiling, wall, stanchion, trunnion

DESIGN FEATURES

- A Rugged design** - Copper-free aluminum housing, tempered and impact resistant glass globe. Outstanding corrosion proof capability (C5M-IEC, UL1598A-UL) and anti vibration design
- B Surge Protection** - 4 kV protection as standard, but option up to 10kV surge protection for offshore applications resistant glass globe.
- C Robust heat sink** - Innovative heat sink facilitates air flow, ensuring long life in extreme environments
- D Installation flexibility** - Stanchion, pendant, ceiling, wall and trunnion mount options allow for easy installation in a variety of applications.
- E Superior optical performance** - Cool white 5700K & warm white 3000K models available. Narrow (25°) / medium (60°) / wide (120°) beam optics available to distribute the light where it is needed the most



† Operating temperature range may vary by lumen models within a product family. Refer to product catalog pages for complete temperature range details.

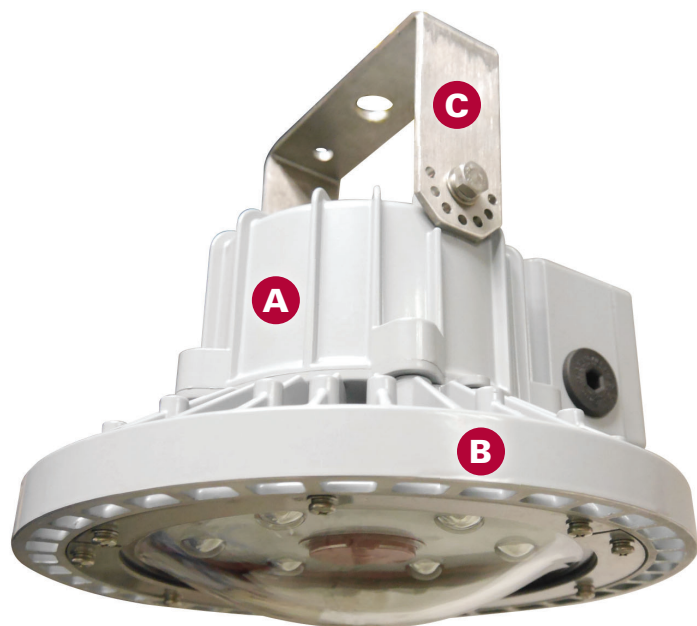
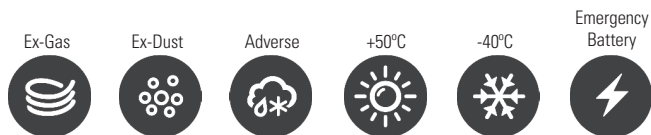

Energy-efficient and globally certified explosionproof workhorse for general area and low/mid bay lighting applications

DESIGN FEATURES

- A Rugged design** - Highly durable aluminum housing with a tempered and impact resistant glass globe. HPL fixture has an operating temperature range of -40°C to +50°C.
- B Lightweight and compact** - Low profile and lightweight design is ideal for compact installations.
- C Ease of installation** - U-shaped yoke mount provides mounting flexibility - wall, ceiling, pole, etc.

HPL LED light fixtures

PRIMARY APPLICATIONS

Certified for Zone 1, 2, 21 and 22 hazardous areas. Suitable for mid bay and low bay lighting applications in chemical, petrochemical, pharmaceutical, platforms, shipyards, loading docks, wastewater treatment and paper mills.

LUMINAIRE MODELS

Model number	Equivalent HID luminaire	Typical energy savings/lifetime
HPL-3L	70W-100W	
HPL-5L	100W-150W	Up to 66% reduction in energy costs
HPL-7L	150W-175W	
HPL-8L	150W-175W	

CERTIFICATIONS & COMPLIANCES

- Ex db e mb IIC T6 Gb
- Ex tb IIIC T80°C Db IP66
- Ex tD A21 IP66 T80°C
- IECEx-Certification of Conformity: IECEx CQM 15.0054X
- EC-Type Examination Certificate: EPT 16 ATEX 2405X
- GB Certificate: GYJ15.1157X
- IP66

ELECTRICAL RATINGS

- Voltages: 100-247 VAC; 108-250 VDC
- Input power: 30W, 50W, 70W, 80W

OPTIONS AND ACCESSORIES

- Clear or diffused glass lens
- Warm white (3000K) and cool white (5700K) color temperatures
- Emergency back-up battery available



† Operating temperature range may vary by lumen models within a product family. Refer to product catalog pages for complete temperature range details.

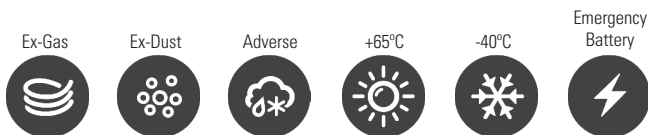

Hazard-Gard™ XPLA linear LED luminaires

PRIMARY APPLICATIONS

Ideal for Class I, Division 1 and Class II, Division 1 areas in wastewater treatment, oil and gas refineries, drilling rigs, petrochemical facilities, food and beverage facilities, tunnels, outdoor wall and stanchion mounted general area lighting, and where flammable vapors, gases, ignitable dusts, fibers or flying are present.

LUMINAIRE MODELS

Model number	Equivalent fluorescent luminaire	Typical energy savings/lifetime
XPLA2	2 x 2 ft. T5/T8/T12HO	Up to 53% reduction in energy costs and 60,000 hours of continuous operation!
XPLA4	2 x 4 ft. T5/T8/T12HO	Up to 53% reduction in energy costs and 60,000 hours of continuous operation!

CERTIFICATIONS & COMPLIANCES

- Class I, Division 1, Groups C, D
- Class II, Division 1, Groups E, F, G
- Class III
- UL844; UL1598; UL1598A
- CSA C22.2 No. 137
- NEMA 4X, IP66, Marine and Wet Locations, Paint spray rated

ELECTRICAL RATINGS

- Voltage: 100-277 VAC/108-250 VDC, 347-480 VAC
- Input power: 34W, 63W, 78W (EM model)

OPTIONS AND ACCESSORIES

- Glass or diffused glass lens
- Epoxy paint finish
- Flush, pole and swivel/surface mounts
- Polycarbonate paint spray lens shield kit
- Safety chain kit



XPLA with emergency battery

Up to 53% more energy efficient than a T5HO fluorescent light and 8 times the rated life

DESIGN FEATURES

- A High efficacy** - Up to 130 lumens per watt.
- B Custom optics** - Standard wide (120°) beam spread maximizes illumination on wall panels.
- C Built to last** - 2,000 psi high pressure hose down rated; passed 5G vibration test; 60,000 hour lifetime @ 55°C ambient.
- D Slim profile** - Less than 5" fixture height (excluding mounting brackets), perfect for mounting in confined or low height areas.
- E Quick & easy installation** - Easy access to drivers and wiring; no custom brackets or hardware needed; Two mounting options available.
- F Emergency battery back-up** - 90-minute minimum run time at 700 lumens in emergency mode.



† Operating temperature range may vary by lumen models within a product family. Refer to product catalog pages for complete temperature range details.

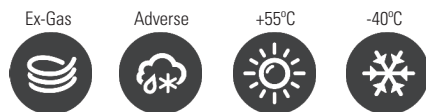

CEAG™ ExLin LED linear light fixtures

PRIMARY APPLICATIONS

Approved for use in Zone 1 and 2 hazardous areas, ExLin provides longer life, improved efficiency and superior performance with a competitive payback versus fluorescent fixtures. Designed to provide general illumination where moisture, dust, corrosion and extreme temperature exist.

LUMINAIRE MODELS

Model number	Equivalent fluorescent luminaire	Typical energy savings/lifetime
ExLin 3L-1	2 x 18W	Up to 40% reduction in energy costs and a rated life of 100,000 hours at 25°C
ExLin 5L-1	2 x 36W	
ExLin 5L-2	2 x 36W	
ExLin 7L-2	2 x 58W	

CERTIFICATIONS & COMPLIANCES

Marking accd.to IECEx:

- Ex eb ib op is q IIC T4 Gb
- Ex tb op is IIIC T80/110°C Db

Marking accd.to 2014/34/EU:

- Ex II 2G Ex eb ib op is q IIC T4/T5 Gb
- Ex II 2D Ex tb op is IIIC T80/110°C Db
- IECEx-Certification of Conformity: IECEx BVS 18.0028X
- EC-Type Examination Certificate: BVS 18 ATEX E 037 X
- IP66/67

ELECTRICAL RATINGS

- Voltages: 110-277 VAC/DC
- Input power: 22W, 44W, 67W

OPTIONS AND ACCESSORIES

- Clear or diffused lens
- Standard, narrow, and wide beam options
- Pole adapter
- Available with V-CG-S emergency lighting technology, allowing the fixtures to be connected to CEAG's central emergency lighting system

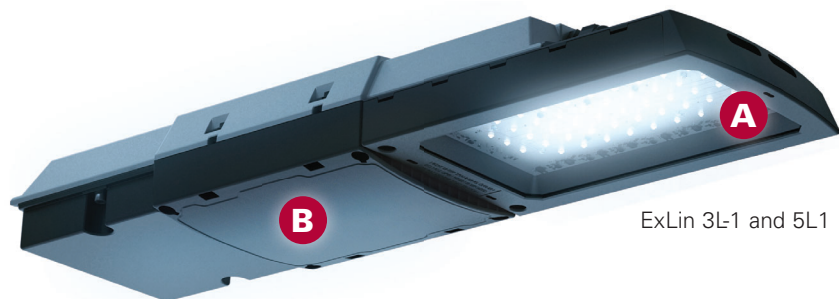

ExLin 3L-1 and 5L1

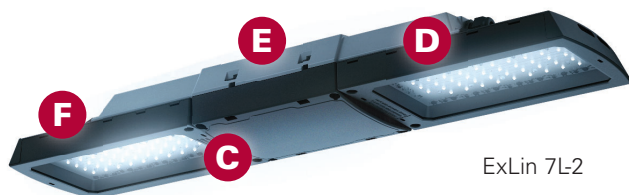

ExLin 7L-2

State-of-the-art LED technology with optimized thermal management and a time-tested, field-proven enclosure

DESIGN FEATURES

- A Superior performance and efficiency** - Up to 120 LM/W provides up to 40% energy efficiency compared to traditional fluorescent fixtures.
- B Built to last** - Rated life of 100,000 hours at 25°C based on L90C5 provides long term, low-maintenance operation.
- C Optimized light distribution** - Standard, narrow and wide beam optics optimise light distribution, providing light where the customer needs it with the potential to reduce the number of fixtures required.
- D Low profile and lightweight** - Decreases footprint in confined applications and reduces installation effort while still providing IK10.
- E Drop-in mounting capability to eLLK fluorescent** - Same fixing point as eLLK 2x18W fixtures and a mounting kit is available allowing for easy replacement of 2x36W and 2x58W without changing cables.
- F Optimized for offshore applications** - Designed to reduce water condensation for high humidity environments and increase reliability in corrosive environments.



† Operating temperature range may vary by lumen models within a product family. Refer to product catalog pages for complete temperature range details.



CEAG™ eLLK LED linear light fixtures

PRIMARY APPLICATIONS

Designed for use in outdoor and indoor hazardous and non-hazardous areas where moisture or corrosion may be a problem, such as offshore oil platforms, pharmaceutical plants, oil refineries and industrial locations.

LUMINAIRE MODELS

Model number	Equivalent luminaire	Battery	Typical energy savings/lifetime
eLLK LED 400A	2x18W fluorescent	No	Up to 20% reduction in energy costs and 60,000 hours of continuous operation!
eLLK LED 800A	2x36W fluorescent	No	
eLLK LED 400A NE	2x18W fluorescent	Yes	
eLLK LED 800A NE	2x36W fluorescent	Yes	

CERTIFICATIONS & COMPLIANCES

- II 2G Ex de mb IIC T4 Gb
- II 2D Ex tb IIIC T80 °C Db IP66
- BVS 09 ATEX E 034
- Ex de mb IIC T4 Gb/Ex tb IIIC T80 °C
- IECEx BVS 09.0033

ELECTRICAL RATINGS

- Voltages: 110-254 VAC, 110-250 VDC; 50/60 Hz
- Input power: 2x13W, 2x26W

OPTIONS AND ACCESSORIES

- LED module 400A (2x13W) for eLLK/M 92 018/18
- LED module 800A (2x26W) for eLLK/M 92 036/36
- Self contained battery system (NE models)
- Available with V-CG-S module for monitoring with an Eaton central battery system

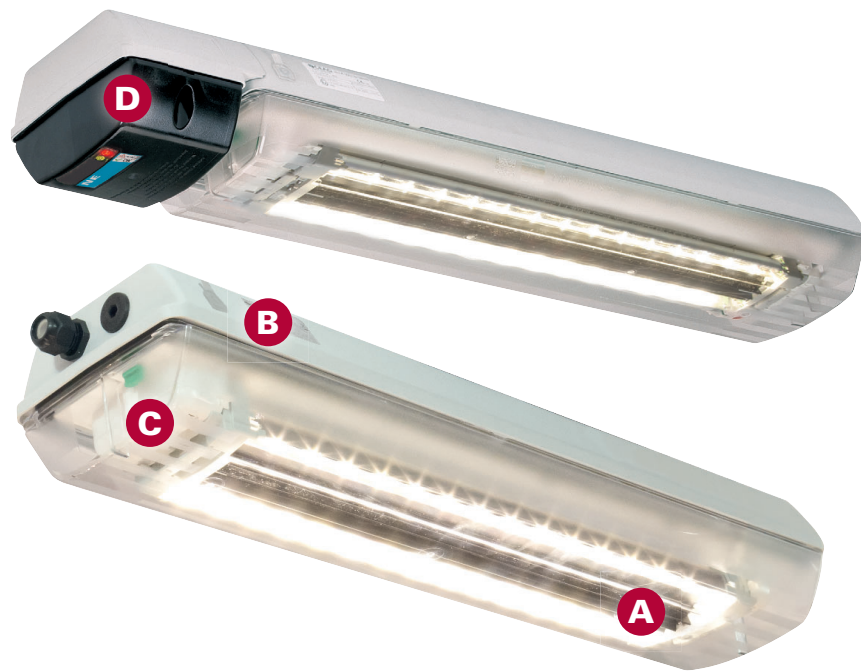

Saves on energy consumption and easily retrofit existing luminaires in hazardous and corrosive environments

DESIGN FEATURES

- A High output** - Illuminance (lux/Fc) equivalent to related fluorescent tubes at measurement plane.
- B Non-metallic design** - Fiberglass-reinforced polyester construction for extreme durability.
- C Retrofit friendly** - Retrofits to existing eLLK/nLLK fixtures with existing EVG 09 ballast or as a complete unit.
- D Emergency** - eLLK NE models include a 7 Ah-NC battery with LED display and monitoring via microprocessor. Provides 1.5 or 3 hours of emergency lighting.



† Operating temperature range may vary by lumen models within a product family. Refer to product catalog pages for complete temperature range details.

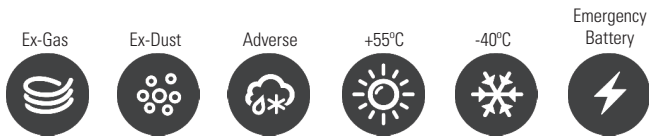

Rugged, low profile fixture that is easy to install and provides clear illumination in Zone 1, 2, 21 and 22 hazardous areas

DESIGN FEATURES

- A Rugged design** - Copper-free aluminum housing and impact-resistant polycarbonate lens provide excellent resistance to corrosion and heat.
- B Easy installation** - Lightweight design, hinged cover, and a terminal block wing for easy installation and maintenance.
- C Industry leading thermal management** - For safe and reliable operation over a wide temperature range.
- D Retrofit friendly** - Fixture utilizes the same mounting footprint of linear fluorescent lighting.

HLL LED linear light fixtures

PRIMARY APPLICATIONS

Constructed with an aluminum housing and high impact-resistant polycarbonate cover, providing extreme durability and reliability in Zone 1, 2, 21 and 22 hazardous areas. Designed for use in hazardous areas where moisture or corrosion may be a problem, such as offshore oil platforms, pharmaceutical and chemical plants, oil refineries and industrial locations.

LUMINAIRE MODELS

Model number	Equivalent luminaire	Typical energy savings/lifetime
HLL-2-3L	2x18W	Up to 39% reduction in energy costs and 50,000 hours of continuous operation!
HLL-4-5L	2x36W	Up to 39% reduction in energy costs and 50,000 hours of continuous operation!

CERTIFICATIONS & COMPLIANCES

- Ex db ec IIC T5/T6 Gc
- Ex ec IIC T5/T6 Gc
- Ex db ec ib mb IIC T5/T6 Gc
- Ex ec ib mb IIC T5/T6 Gc
- Ex tb IIIC T80°C Db
- IECEx-certification of conformity: IECEx CQM 16.0030X
- EC-Type examination certificate: CML 17ATEX3305X
- IP66

ELECTRICAL RATINGS

- Voltages: 100-240 VAC, 108-250 VDC
- Input power: 40W, 80W

OPTIONS AND ACCESSORIES

- Epoxy coating on aluminum housing
- Emergency battery back-up
- Pipe, wall, and ceiling mounts available



† Operating temperature range may vary by lumen models within a product family. Refer to product catalog pages for complete temperature range details.

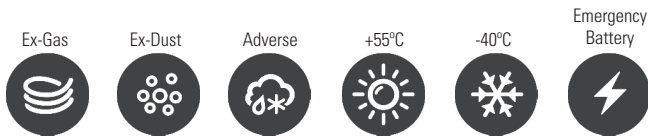

HRL LED recessed linear light fixtures

PRIMARY APPLICATIONS

Engineered to provide maintenance-free illumination in the most demanding environments, along with a competitive payback vs. fluorescent fixtures. Available in three common sizes, the HRL is certified for use in Zones 1, 21, 2, and 22 hazardous areas, as well as Class I, Division 2 locations.

LUMINAIRE MODELS

Model number	Equivalent luminaire	Battery	Typical energy savings/lifetime
HRL3060	2x18W fluorescent	Yes	Up to 20% reduction in energy costs and 55,000 hours of continuous operation!
HRL3012	2x36W fluorescent	Yes	
HRL6060	4x18W fluorescent	Yes	

CERTIFICATIONS & COMPLIANCES

- II 2G Ex de mb IIC T4 Gb
- II 2D Ex tb IIIC T80 °C Db IP66
- BVS 09 ATEX E 034
- Ex de mb IIC T4 Gb/Ex tb IIIC T80 °C
- IECEx BVS 09.0033

ELECTRICAL RATINGS

- Voltages: 110-254 VAC, 110-250 VDC; 50/60 Hz
- Input power: 2x13W, 2x26W

OPTIONS AND ACCESSORIES

- LED module 400A (2x13W) for eLLK/M 92 018/18
- LED module 800A (2x26W) for eLLK/M 92 036/36
- Self contained battery system (NE models)
- Available with V-CG-S module for monitoring with an Eaton central battery system



State-of-the-art LED technology and optimized thermal management extend service life in extreme environments

DESIGN FEATURES

- A High output** - Illuminance (lux/Fc) equivalent to related fluorescent tubes at measurement plane.
- B Non-metallic design** - Fiberglass-reinforced polyester construction for extreme durability.
- C Retrofit friendly** - Retrofits to existing eLLK/nLLK fixtures with existing EVG 09 ballast or as a complete unit.
- D Emergency** - eLLK NE models include a 7 Ah-NC battery with LED display and monitoring via microprocessor. Provides 1.5 or 3 hours of emergency lighting.



† Operating temperature range may vary by lumen models within a product family. Refer to product catalog pages for complete temperature range details.

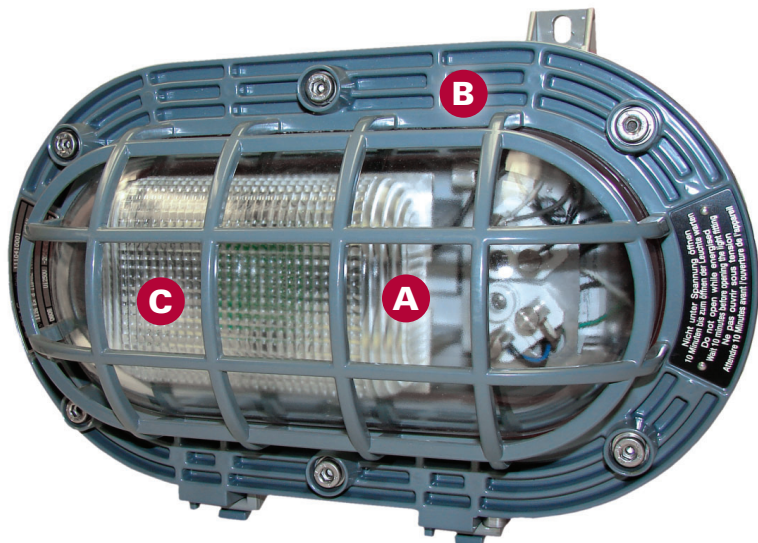

Up to 6 times longer life and 65% reduction in power consumption compared to equivalent HID floodlights

DESIGN FEATURES

- A Shock- and vibration-resistant** - Durable vibration-resistant LEDs decrease maintenance costs.
- B Lightweight enclosure** - Robust light alloy enclosure weighs only 7.0 kg, allowing the user to mount in areas where the available space is restricted, and making installation fast and easy.
- C Instant illumination and restrike** - Decreases facility downtime; no warm-up time required.



† Operating temperature range may vary by lumen models within a product family. Refer to product catalog pages for complete temperature range details.

AB05 LED marine wallpack

PRIMARY APPLICATIONS

Perfect for confined or restricted spaces, such as stairwells, storage areas and corridors that require consistent light.

LUMINAIRE MODELS

Model number	Equivalent luminaire	Typical energy savings/lifetime
AB05	150W incandescent	Up to 80%
60,000 hours of continuous operation!		

CERTIFICATIONS & COMPLIANCES

- Zone 1, 2, 21, 22
- Ex d IIB T6
- Ex II 2 G Ex d IIB T6/T5 Gb
- Ex II 2 D Ex tb IIIC T80°C/T100°C Db
- Certificate BVS 09 ATEX E 014 X
- IP66

ELECTRICAL RATINGS

- Voltage: 120-240 VAC
- Input power: 32W

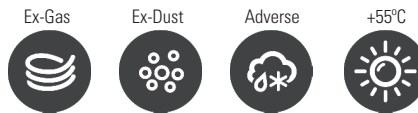

Hazard-Gard™ EV LED light fixtures

PRIMARY APPLICATIONS

Indoors or outdoors in process and storage areas, corridors, bridges and stairs.

LUMINAIRE MODELS

Model number	Equivalent luminaire	Typical energy savings/lifetime
EVLEDC201	100W-200W incandescent	Up to 85% reduction in energy costs and 50,000 hours of continuous operation!
EVLEDC701	70W-100W HID	Up to 85% reduction in energy costs and 50,000 hours of continuous operation!

CERTIFICATIONS & COMPLIANCES

- Class I, Division 1, Groups C, D
- Class I, Zone 1 & 2, Group IIB
- Class II, Division 1, Groups E, F, G
- Class III; Simultaneous Presence
- UL844; UL1598; UL1598A
- CSA C22.2 No. 137
- Type 4X, IP66

ELECTRICAL RATINGS

- Voltages: 100-277 VAC, 10-30 VDC
- Input power: 15W, 30W

OPTIONS AND ACCESSORIES

- Amber color for wildlife-friendly applications
- Color temperature: cool white (3000K) and warm white (5600K)
- 24-27 VDC



Up to 85% reduction in energy costs and 50,000 hours of continuous operation

DESIGN FEATURES

- A Retrofittable mounting modules** - Compatible with existing EV Series mounting modules, which reduces retrofit installation time and materials costs, and makes new construction installation easy.
- B 20 times longer life than incandescents in tough-to-maintain Division 1 locations.**



† Operating temperature range may vary by lumen models within a product family. Refer to product catalog pages for complete temperature range details.

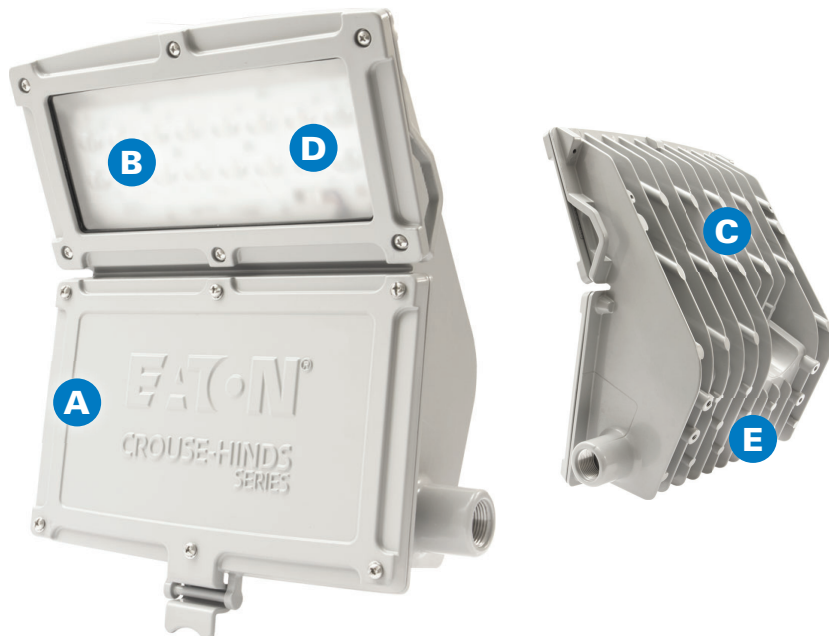

Industry-leading performance and reliability for outdoor area and site lighting in industrial locations

DESIGN FEATURES

- A Built to last** - Rated for 60,000+ hours of operation at 55°C. Impact-resistant lens sealed from the outside environment provides ingress protection against water and dust
- B High efficiency** - Up to 116 lumens per watt
- C Rugged Design** - Engineered to perform in ambient temperatures from -40°C to +55°C. Die cast aluminum LED housing provides efficient thermal path to heat sink assembly, and vertical fin design facilitates air flow and dust shedding.
- D Multiple optic and lens options** - Narrow and wide optics for ideal light output. Four lens styles provide flexibility for specific applications and customer preferences
- E Simple installation** - Contractor-friendly design is ideal for both retrofit and new construction. Available with lever lock connectors



† Operating temperature range may vary by lumen models within a product family. Refer to product catalog pages for complete temperature range details.

* Refer to www.designlights.org Qualified Products List under family models for full listing details. Not all models are approved for all application categories.

Champ™ Pro WPMV LED wallpack light fixtures

PRIMARY APPLICATIONS

Provides a low profile solution for industrial lighting applications. It's the ideal choice for vertical surface lighting where harsh conditions require high quality, reliable illumination.

LUMINAIRE MODELS

Model number	Equivalent HID luminaire	Typical energy savings/lifetime
WPMV3L	70W	Up to 70% reduction in energy costs and 60,000 hours of continuous operation!
WPMV5L	100W	
WPMV7L	150W-175W	

CERTIFICATIONS & COMPLIANCES

- UL1598; UL1598A; UL8750
- CSA C22.2 No. 137
- NEMA 4X, IP66, Marine and Wet Locations
- DesignLights Consortium® pending*



ELECTRICAL RATINGS

- Voltage: 100-277 VAC, 347-480 VAC, 125/250 VDC
- Input power: 30W, 45W, 59W

OPTIONS AND ACCESSORIES

- Available with a variety of lens types, including clear glass, diffused glass, clear polycarbonate and diffused polycarbonate
- Yoke mount and hub mount options are available
- Available with a photocell

Champ™ Pro PFMA LED floodlights

PRIMARY APPLICATIONS

Indoor and outdoor area lighting in manufacturing plants, mine sites and processing areas, platforms, loading docks and parking areas.

LUMINAIRE MODELS

Model number	Equivalent HID luminaire	Typical energy savings/lifetime
PFMA3L	70W	Up to 78% reduction in energy costs and 60,000 hours of continuous operation!
PFMA5L	100W	
PFMA7L	175W	
PFMA9L	250W	
PFMA11L	320W	
PFMA13L	400W	
PFMA15L	500W	
PFMA20L	600W-750W	
PFMA25L	750W-1000W	
PFMA40L	1,500W+	
PFMA50L	1,500W+	

CERTIFICATIONS & COMPLIANCES

- UL1598; UL1598A; UL8750
- cUL
- Type 4X
- IP66
- DesignLights Consortium® approved for select models* 
- UL approved up to 65°C ambient (3L-15L)
- cUL Listed to CSA Standard CSA C22.2 No. 250
- IEC Standards: IEC 60598; CE

ELECTRICAL RATINGS

- Voltages: 100-277 VAC, 347-480 VAC, 108-250 VDC
- Input power: 28W, 45W, 62W, 79W, 99W, 112W, 131W, 175W, 216W, 340W, 411W

OPTIONS AND ACCESSORIES

- Bolt-on visor and Bolt-on wire guard
- Floodlight slipfitter (not available on 40L & 50L)
- Slipfitter wall mount adapter (not available on 40L & 50L)
- Polycarbonate lens
- Diffused glass lens
- Dimmable driver (NEC only)
- 3x3 optic (select models)

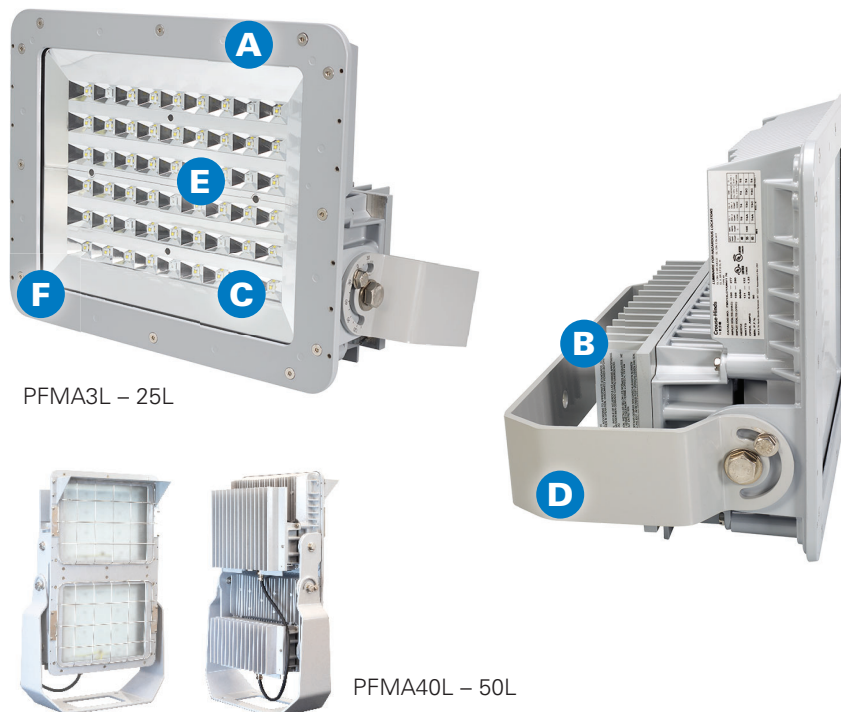

Up to 6 times longer life and 78% reduction in power consumption compared to equivalent HID floodlights

DESIGN FEATURES

- A Versatile design** - Can be used for outdoor or indoor applications, and for a wide range of mounting heights depending on model and light level requirement.
- B Rugged heat sink** - Designed to perform in high ambient temperatures up to +65°C and as low as -40°C. The thick walls of the castings make for a tough, rugged housing that keeps the internal driver and LED temperatures down.
- C High lumen output** - Up to 120 lumens per watt.
- D Full-frame yoke** - Designed to utilize the SFA6 slipfitter and SWB6 wall mount bracket, making it ideal for retrofit or new installations (not available on 40L & 50L).
- E Multiple lens options** - Tempered and clear glass standard, polycarbonate and diffused glass options available.
- F Smaller and lighter** - 25% smaller and 10 lbs (4.5 kg) lighter than previous model (3L-25L models).



† Operating temperature range may vary by lumen models within a product family. Refer to product catalog pages for complete temperature range details.

* Refer to www.designlights.org Qualified Products List under family models for full listing details. Not all models are approved for all application categories.

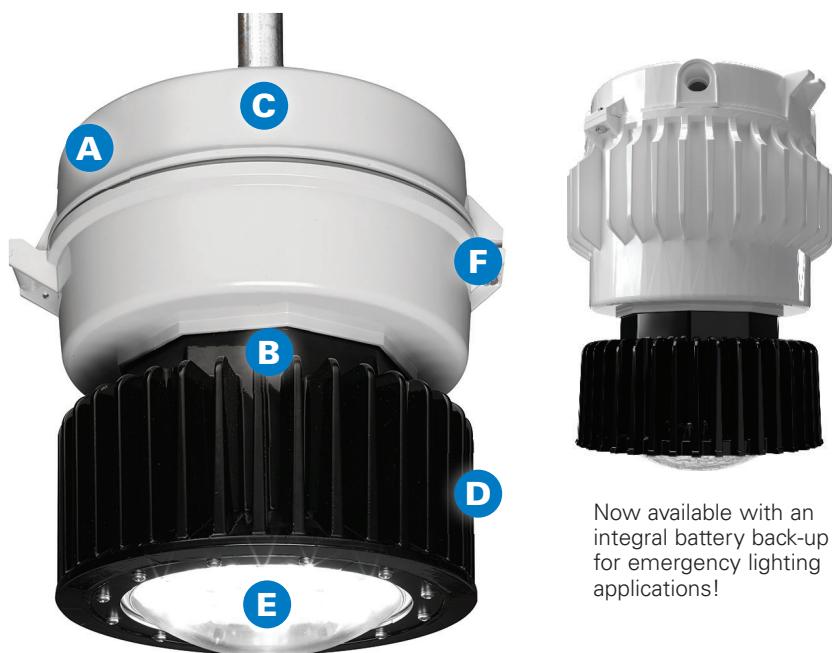

PVML-3 – PVML-11

Now available with an integral battery back-up for emergency lighting applications!

Custom Type I, III and V optics for better output, zero maintenance and reduced energy consumption

DESIGN FEATURES

- A Modular design** - This contractor-friendly design is ideal for both retrofit and new construction applications.
- B Safe, reliable heat transfer** - Die cast aluminum housing provides safe and effective heat transfer from the LED assembly to the outside environment, ensuring low LED junction temperature, reliability and sustained lumen performance.
- C High efficiency drivers** - Designed to provide reliable operation in even the harshest environments.
- D Type 4X rated** - The LED housing is constructed of durable die cast aluminum, providing an efficient thermal path to the heat sink assembly. The impact-resistant lens is sealed from the outside environment and provides ingress protection against water and dust.
- E Custom optics** - Type I, III and V optics designed to maximize light distribution and intensity.
- F Lever-lock connectors and 3-pole terminal block.**



† Operating temperature range may vary by lumen models within a product family. Refer to product catalog pages for complete temperature range details.

* Refer to www.designlights.org Qualified Products List under family models for full listing details. Not all models are approved for all application categories.

Champ™ Pro PVML LED light fixtures

PRIMARY APPLICATIONS

Locations requiring continuous and consistent light levels in extreme ambient temperatures, such as manufacturing plants, mine sites, heavy industrial or petrochemical facilities, food and beverage facilities, marine environments, platforms, loading docks, tunnels, outdoor wall and stanchion mounted general area lighting.

LUMINAIRE MODELS

Model number	Equivalent HID luminaire	Typical energy savings/lifetime
PVML-3	70W	
PVML-5	100W	
PVML-7	175W	Up to 77% reduction in energy costs and 60,000 hours of continuous operation!
PVML-9	250W	
PVML-11	320W	
PVML-13	400W	
PVML-17	400W-600W	
PVML-21	600W-750W	
PVML-25	750W-1,000W	

CERTIFICATIONS & COMPLIANCES

- UL1598; UL1598A
- cUL
- NEMA 4X, IP66, Wet Locations
- DesignLights Consortium® approved for select models*
- cUL Listed to CSA Standard CSA C22.2 No. 250
- IEC standard: CE
- UL approved up to 65°C ambient (3L-11L UNV1; all other models 55°C)



ELECTRICAL RATINGS

- Voltages: 120-277 VAC/108-250 VDC, 347/480 VAC
- Input power: 29W, 41W, 54W, 74W, 89W, 130W, 168W, 196W, 232W

OPTIONS AND ACCESSORIES

- Integral back-up battery (90 minutes of emergency lighting)
- Quick clip to simplify installation
- Diffused lens, teflon coated lens, and polycarbonate lens
- Wire guard
- Trunnion mount
- Cone top hat
- Type I, III and V optics
- Occupancy sensor and remote

Champ™ Pro PVMA LED light fixtures

PRIMARY APPLICATIONS

Ideal for a variety of non-hazardous medium or heavy-duty applications such as mining, marine, food processing, pulp and paper, wastewater treatment, power generation, and general industrial manufacturing areas.

LUMINAIRE MODELS

Model number	Equivalent HID luminaire	Typical energy savings/lifetime
PVMA5L	150W	Up to 77% reduction in energy costs and 60,000 hours of continuous operation!
PVMA7.5L	175W	

CERTIFICATIONS & COMPLIANCES

- UL1598; UL1598A
- CSA C22.2 No. 250
- IP66, Wet Locations
- RoHS
- IEC Standards: IEC 60598; CE
- DesignLights Consortium® approved for select models*



ELECTRICAL RATINGS

- Voltage: 100-277 VAC, 347-480 VAC, 127-300 VDC
- Input power: 48W, 64W

OPTIONS AND ACCESSORIES

- Ceiling, pendant, cone pendant, wall, and trunnion mounts
- Safety cable
- Quick clip

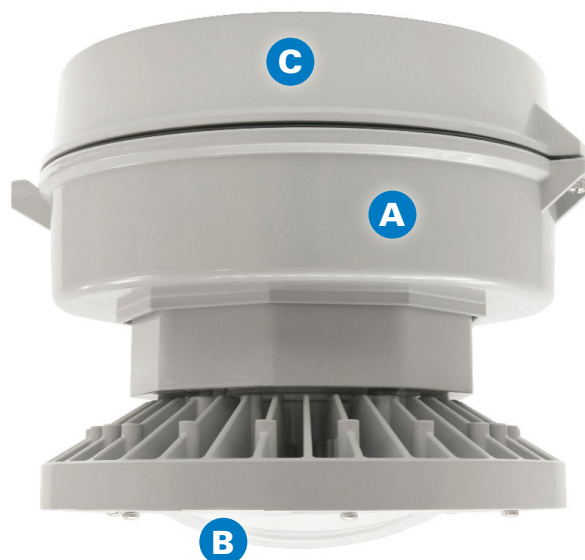

Smaller footprint, lightweight design, and maintenance-free illumination in demanding environments

DESIGN FEATURES

- A Rugged design** - Engineered for durability in complex environments.
- B High efficiency** - Up to 122 LPW and custom optics to maximize light on the work plane.
- C Ease of installation** - Compact footprint with ceiling, pendant, wall or stanchion mount options and the ability to retrofit Crouse installed base.



NEC



CEC

† Operating temperature range may vary by lumen models within a product family. Refer to product catalog pages for complete temperature range details.

* Refer to www.designlights.org Qualified Products List under family models for full listing details. Not all models are approved for all application categories.

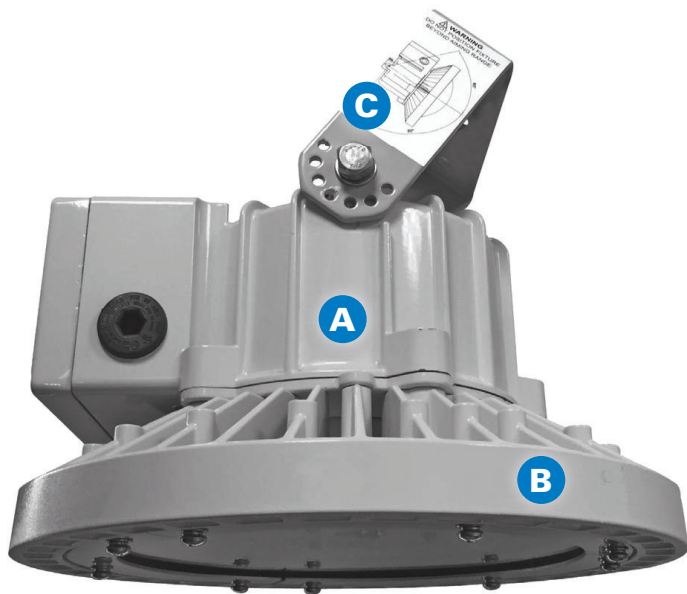
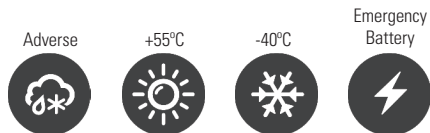

Low profile and lightweight design, easy to install and reliable illumination is demanding environments

DESIGN FEATURES

- A Rugged design** - Highly durable aluminum housing with a tempered and impact resistant glass globe. PLE fixture has an operating temperature range of -40°C to +55°C.
- B Lightweight and compact** - Low profile and lightweigh design is ideal for compact installations.
- C Ease of installation** - U-shaped yoke mount provides mounting flexibility - wall, ceiling, pole, etc.



† Operating temperature range may vary by lumen models within a product family. Refer to product catalog pages for complete temperature range details.

PLE LED light fixtures

PRIMARY APPLICATIONS

Ideal for a variety of non-hazardous medium or heavy-duty applications such as mining, platforms, loading docks, tunnels, and general industrial manufacturing areas.

LUMINAIRE MODELS

Model number	Equivalent HID luminaire	Typical energy savings/lifetime
PLE-3L	70W-100W	
PLE-5L	100W-150W	Up to 66% reduction in energy costs
PLE-7L	150W-175W	
PLE-8L	150W-175W	

CERTIFICATIONS & COMPLIANCES

- IEC Standard: CE
- IP66

ELECTRICAL RATINGS

- Voltages: 100-240 VAC; 108-250 VDC
- Input power: 30W, 50W, 70W, 80W

OPTIONS AND ACCESSORIES

- Emergency battery
- Clear or diffused glass lens
- Warm white (3000K) and cool white (5700K) color temperatures

Champ™ Pro PLLA LED linear light fixtures

PRIMARY APPLICATIONS

Ideal for a variety of non-hazardous applications such as mining, food processing, marine, waste-water treatment heavy manufacturing and general wash down areas.

LUMINAIRE MODELS

Model number	Equivalent fluorescent luminaire	Typical energy savings/lifetime
PLLA2	2 x 2 ft. T5/T8/T12HO	Up to 63% reduction in energy costs and 60,000 hours of continuous operation!
PLLA4	2 x 4 ft. T5/T8/T12HO	Up to 63% reduction in energy costs and 60,000 hours of continuous operation!

CERTIFICATIONS & COMPLIANCES

- UL1598; UL1598A; UL924
- CSA C22.2 No. 250
- Type 4X, IP66, Wet Locations
- ABS design assessed
- DesignLights Consortium® approved for select models*



ELECTRICAL RATINGS

- Voltage: 100-277 VAC, 347-480 VAC, 108-250 VDC
- Input power: 32W, 63W

OPTIONS AND ACCESSORIES

- Available with a self-contained battery system for emergency lighting applications
- Polycarbonate lens, available in clear or diffused
- Flush/back, ceiling/swivel, wall, offset wall, pole and pendant mounts
- Safety chain kit
- Epoxy painted or natural aluminum finish
- Emergency back-up battery option

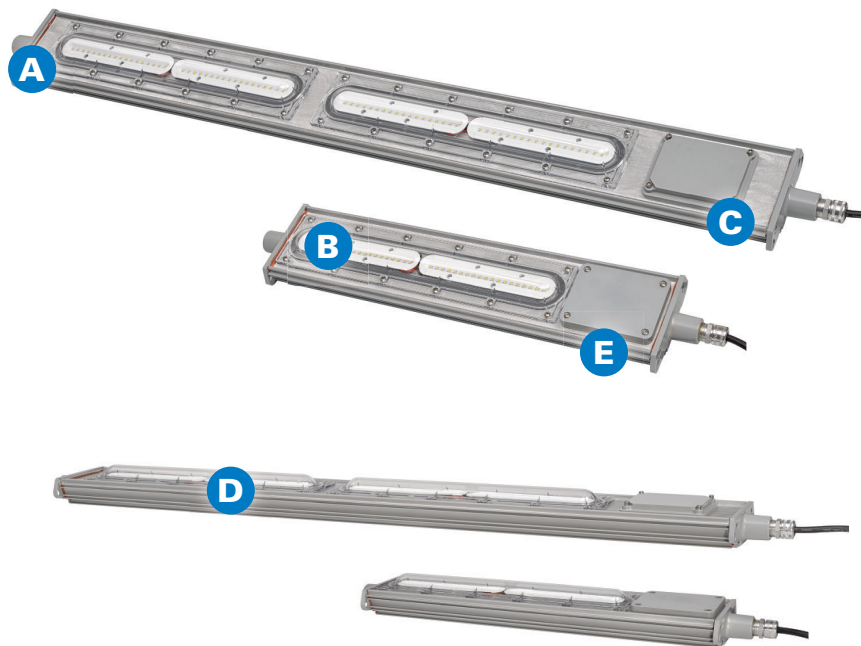
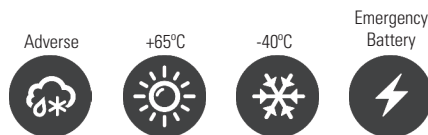

Up to 63% more energy efficient than a T5HO fluorescent light and 8 times the rated life

DESIGN FEATURES

- A Best-in-class efficacy** - Up to 123 lumens per watt.
- B Custom optics** - Standard wide (120°) and narrow (80°) beam pattern for a wide variety of general and targeted lighting applications.
- C Built to last** - 2,000 psi high pressure hose down rated; high vibration resistant; 60,000 hour lifetime @ 55°C ambient.
- D Slim profile** - 2.7" fixture height (excluding mounting brackets), perfect for mounting in confined or low height areas.
- E Quick & easy installation** - Easy access to drivers and wiring; no custom brackets or hardware needed; Seven mounting options available.



† Operating temperature range may vary by lumen models within a product family. Refer to product catalog pages for complete temperature range details.

* Refer to www.designlights.org Qualified Products List under family models for full listing details. Not all models are approved for all application categories.

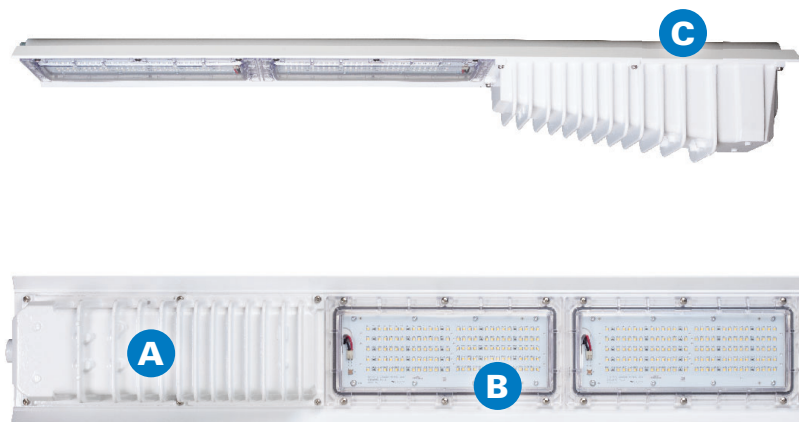
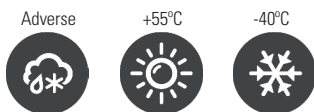

NSF Splash Zone rated, 1500 PSI hose down tested and an angled housing to mitigate debris build-up

DESIGN FEATURES

- A Innovative and robust design** - Angled light fixture mitigates debris build-up. Withstands 1500 psi high pressure wash down, and food rated paint maintains safety.
- B High performance optics and drivers** - 100+ lumens per watt provides highly efficient lighting. Rated life is up to 60,000 hours of maintenance-free and safe operation.
- C Easily customized for application-specific performance** - Versatile mounting options with a through feed design for simplified multiple fixture wiring.



† Operating temperature range may vary by lumen models within a product family. Refer to product catalog pages for complete temperature range details.

Pauluhn™ APEX LED linear light fixtures

PRIMARY APPLICATIONS

Replaces fluorescent T12, T8, and T5HO fixtures in hose down, corrosive and heavy industrial environments.

The APEX LED was designed with food and beverage processing facilities in mind. The fixture housing is angled to mitigate debris build-up and features a food-rated epoxy powder coat finish. Plus, its robust design can withstand 1,500 PSI hose pressure for wash down applications.

LUMINAIRE MODELS

Model number	Equivalent luminaire	Typical energy savings/lifetime
APX13L	3 lamp T5HO	Up to 50% reduction in energy costs and minimum 60,000 hours of continuous operation!
APX17L	4 lamp T5HO	
APX25L	6 lamp T5HO	

CERTIFICATIONS & COMPLIANCES

- UL1598; UL8750
- CSA 22.2 No. 250
- NSF Splash Zone
- Type 4X; IP66

ELECTRICAL RATINGS

- Voltages: 100-277 VAC/347-480 VAC, 127-250 VDC
- Input power: 122W, 144W, 217W

OPTIONS AND ACCESSORIES

- Polycarbonate lens in clear or diffused
- Optional 0-10V dimming capabilities
- Surface/swivel mount, cable/chain mount and threaded rod mount
- Available with cord assemblies and quick disconnect receptacle

Pauluhn™ Intrepid LED linear light fixtures

PRIMARY APPLICATIONS

A low/mid bay linear LED fixture for industrial and marine locations. The Intrepid is available with a non-metallic housing and is Type 4X / IP66 rated for moisture protection in hose down and marine applications.

LUMINAIRE MODELS

Model number	Equivalent fluorescent luminaire	Typical energy savings/lifetime
FPS2L	2 x 2 ft. T8/	Up to 63% reduction in energy costs and 60,000 hours of continuous operation!

CERTIFICATIONS & COMPLIANCES

- UL1598; UL1598A; UL924
- CSA C22.2 No. 250
- Type 4X
- IP66
- NSF Splash Zone
- ABS approved (pending)

ELECTRICAL RATINGS

- Voltage: 100-277 VAC
- Input power: 27W, 37W (EM model)

OPTIONS AND ACCESSORIES

- Red and Blue color LEDs for naval applications
- Emergency battery back-up
- Surface and pole mounts

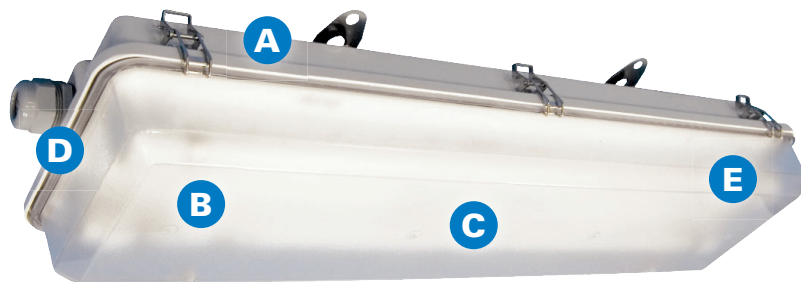
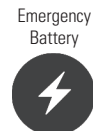

A nonmetallic, corrosion-resistant LED fixture designed for hose down and marine applications

DESIGN FEATURES

- A Built to last** - Nonmetallic housing and stainless steel mounts and latches provide excellent resistance to corrosion.
- B Low-glare design** - Diffused lens minimizing glare in low mounting height applications.
- C Color LED options** - Available with red or blue LEDs for naval or emergency applications.
- D Installation-friendly** - Versatile options for terminal blocks and through feed.
- E Emergency** - Available with a self-contained battery system for emergency power loss applications.



NEC



CEC

† Operating temperature range may vary by lumen models within a product family. Refer to product catalog pages for complete temperature range details.

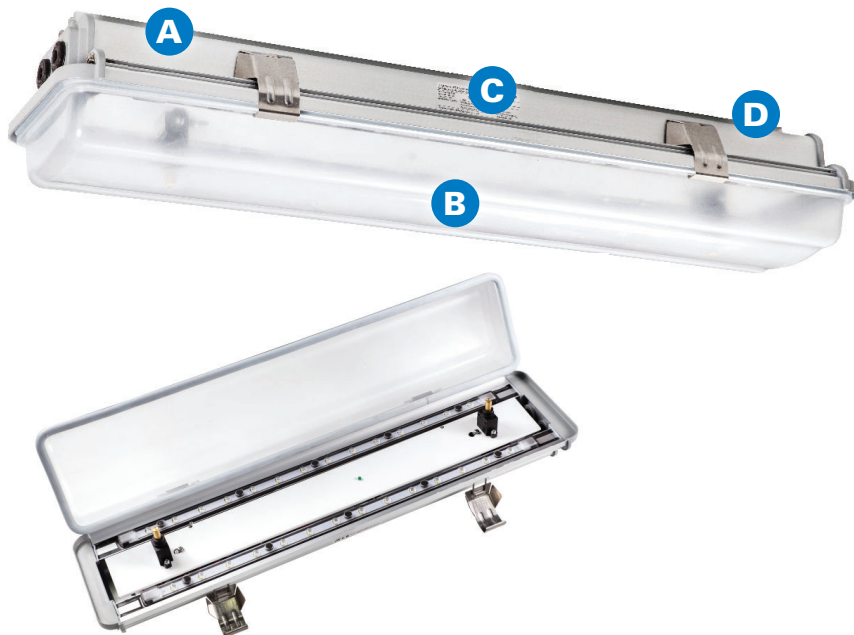
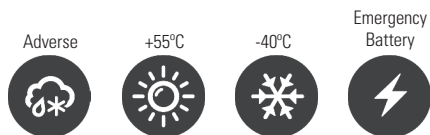

Rugged, low profile fixture that is easy to install and provides clear illumination in challenging areas

DESIGN FEATURES

- A Rugged design** - Copper-free aluminum housing and impact-resistant polycarbonate lens provide excellent resistance to corrosion and heat.
- B Easy installation** - Lightweight design, hinged cover, and a terminal block wing for easy installation and maintenance.
- C Industry leading thermal management** - For safe and reliable operation over a wide temperature range.
- D Retrofit friendly** - Fixture utilizes the same mounting footprint of linear fluorescent lighting.



† Operating temperature range may vary by lumen models within a product family. Refer to product catalog pages for complete temperature range details.

PLLE LED linear light fixtures

PRIMARY APPLICATIONS

Constructed with an aluminum housing and high impact-resistant polycarbonate cover for use in outdoor and indoor industrial areas where moisture or corrosion may be a problem, such as offshore oil platforms, pharmaceutical and chemical plants, oil refineries and industrial locations.

LUMINAIRE MODELS

Model number	Equivalent luminaire	Typical energy savings/lifetime
PLLE-2-C2-3L	2x18W	Up to 39% reduction in energy costs and 50,000 hours of continuous operation!
PLLE-2-C2-4L	2x36W	
PLLE-4-C2-5L	2x36W	
PLLE-4-C2-8L	2x58W	

CERTIFICATIONS & COMPLIANCES

- CE self declared
- IP66

ELECTRICAL RATINGS

- Voltages: 100-240 VAC
- Input power: 30W, 40W, 60W, 80W

OPTIONS AND ACCESSORIES

- Epoxy coating on aluminum housing
- Emergency battery back-up
- Pipe, wall, and ceiling mounts available

CEAG™ LLK15 LED linear light fixtures

PRIMARY APPLICATIONS

Crisp, bright light and durability in wet and harsh environments. Wide ambient temperature range from -40° to +55°C. Heavy duty, non-metallic construction stands up to dust, dirt, gas, vapor, smoke, fumes, moisture, corrosive and wet conditions are present.

LUMINAIRE MODELS

Model number	Equivalent fluorescent luminaire	Typical energy savings/lifetime
LLK15 LED 600	2 x 18W	Up to 60% more efficient than fluorescent light fixtures
LLK15 LED 1200	2 x 36W	
LLK15 LED 1500	2 x 58W	

CERTIFICATIONS & COMPLIANCES

- IP66
- Operating temperature range -40°C to +55°C

ELECTRICAL RATINGS

- Voltage: 220-240 VAC
- Input power: 18W, 37W, 49W

OPTIONS AND ACCESSORIES

- Available with safety switch on request
- Wall mount brackets, ceiling mount brackets and pipe clamps
- Available with battery
- Available with V-CG-S module for monitoring with an Eaton central battery system
- Available with DALI

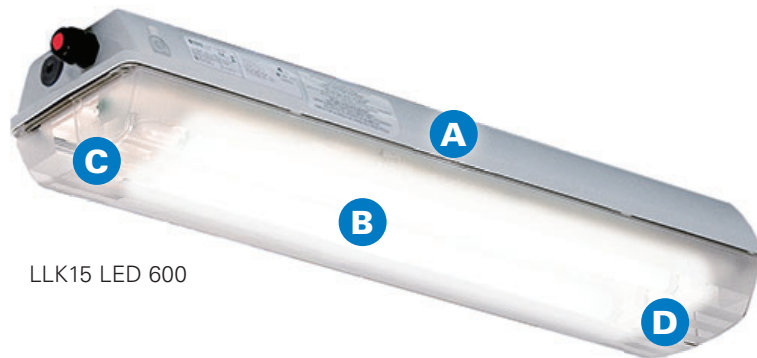
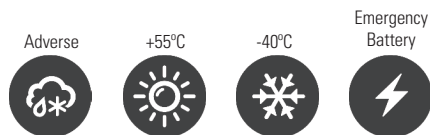

LLK15 LED 600



LLK15 LED 1200 and 1500

A rugged and durable LED fixture designed reliable performance in extreme ambient temperatures

DESIGN FEATURES

- A Built to last** - Heavy duty, non-metallic construction stands up to tough physical and environmental demands, making it an excellent choice where dust, dirt, gas, vapor, smoke, fumes, moisture, corrosive and wet conditions are present.
- B High output** - Utilizes long-life LED tubes for extreme applications, providing high efficacy and long life.
- C Extreme temperatures** - Rated for use in ambient temperatures from -40°C to +55°C
- D Emergency** - Available with a self-contained battery system or V-CG-S module for monitoring with an Eaton central battery system.

† Operating temperature range may vary by lumen models within a product family. Refer to product catalog pages for complete temperature range details.

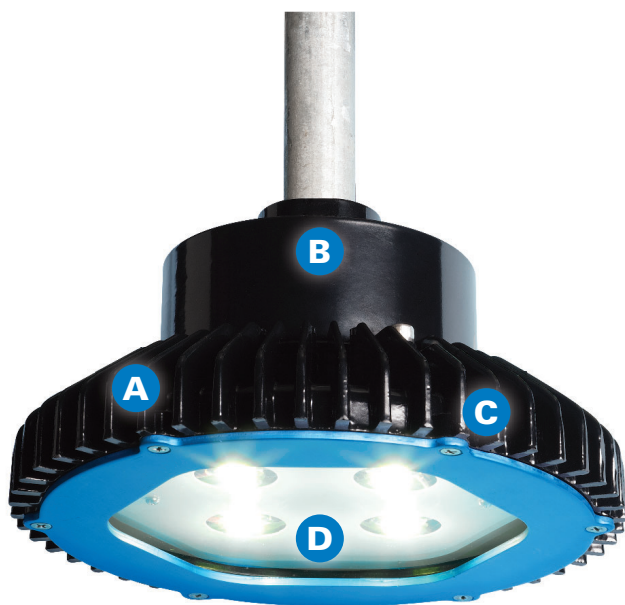

85% more energy-efficient than a 200 watt incandescent and over 20 times the rated life

DESIGN FEATURES

- A Domeless reflector, low profile design** - Designed for low mounting heights and confined spaces where incandescent and HID based luminaires are too large.
- B Installation and replacement made simple** - Installed using the same mounting modules as existing Eaton's Crouse-Hinds Vaporgard fixtures.
- C Safe, reliable heat transfer** - Heat sink engineered to safely and effectively remove heat from the LED and driver, ensuring long product life and superior T-ratings.
- D High power multi-die LED arrays** - Provides instant on and full illumination in the harshest conditions, even when exposed to high, repeated vibration.



† Operating temperature range may vary by lumen models within a product family. Refer to product catalog pages for complete temperature range details.

* Refer to www.designlights.org Qualified Products List under family models for full listing details. Not all models are approved for all application categories.

Vaporgard™ Pro P2L/P3L LED light fixtures

PRIMARY APPLICATIONS

Indoor or outdoor areas with low mounting heights or confined spaces, such as tunnels and catwalks, over doorways or entries, landing areas, utility rooms, etc.

LUMINAIRE MODELS

Model number	Equivalent HID luminaire	Typical energy savings/lifetime
P2LM2	50W HID or 150-200W incandescent	Up to 85% reduction in energy costs and 50,000 hours of continuous operation!
P3LM2		

CERTIFICATIONS & COMPLIANCES

- UL1598
- UL1598A Marine
- cUL Listed to CSA Standard CSA 22.2 No. 250
- Type 4X, IP66, Wet Locations
- DesignLights Consortium® approved for select models*
- IEC Standard: CE



ELECTRICAL RATINGS

- Voltages: 120-277 VAC, 12-24 VDC
- Input power: 14W, 29W

OPTIONS AND ACCESSORIES

- Frosted/Diffused lens
- Teflon coated lens
- Warm white (3000K), Neutral (400K) and cool white (5000K) color temperatures
- 10-30 VDC driver
- Wall, ceiling, pendant and stanchion mounts

Champ™ Pro PVM High Bay LED

PRIMARY APPLICATIONS

A durable, high lumen solution for industrial areas with mounting heights from 60 to 100+ feet. Common applications include production facilities, clean rooms, packaging facilities and warehouses.

LUMINAIRE MODELS

Model number	Equivalent HID luminaire	Typical energy savings/lifetime
PVM60L	1000W	Up to 65% reduction in energy costs and 60,000 hours of continuous operation!
PVM85L	1500W	Up to 65% reduction in energy costs and 60,000 hours of continuous operation!

CERTIFICATIONS & COMPLIANCES

- cULus wet location
- Type 4X, IP66
- ROHS compliant
- DesignLights Consortium® approved for select models*



ELECTRICAL RATINGS

- Voltage: 277-480 VAC
- Input power: 472W, 678W

OPTIONS AND ACCESSORIES

- Two CCT colors: 4000K and 5000K at 85 CRI
- Medium, narrow, wide and extra wide optics
- Control options include standard fixed output or optional 0-10V dimming
- Universal mounting allows for suspended, pipe or hook mount. Optional surface mount bracket available
- Available with cord assemblies and plugs

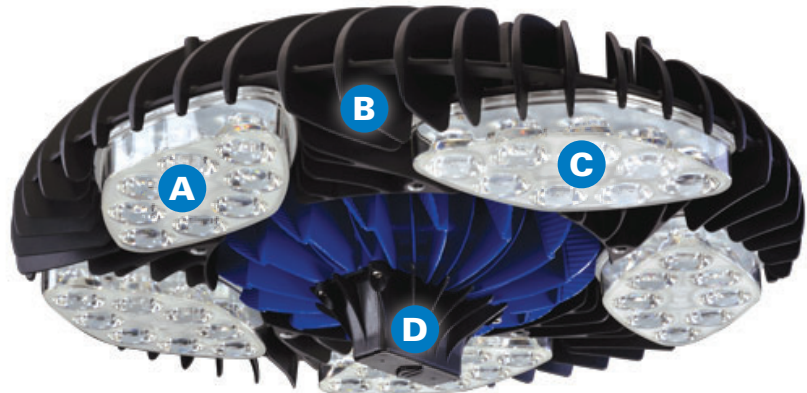
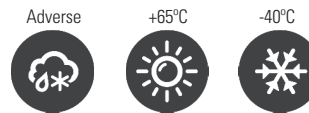

Delivers up to 85,000 lumens for industrial areas with mounting heights from 60 to 100+ feet.

DESIGN FEATURES

- A Best-in-class efficacy** - Up to 132 lumens per watt.
- B Built to last** - Constructed of heavy duty, die cast aluminum with a 3G vibration rating and an operating temperature range of -40°C to +65°C (60,000 lumen model) and -40°C to +50°C (85,000 lumen model).
- C Custom optics** - Narrow, medium, wide and extra wide distribution options ensures superior performance to key areas within an application.
- D Dimming capabilities** - Control options include standard fixed output or optional 0-10V dimming.



† Operating temperature range may vary by lumen models within a product family. Refer to product catalog pages for complete temperature range details.

* Refer to www.designlights.org Qualified Products List under family models for full listing details. Not all models are approved for all application categories.

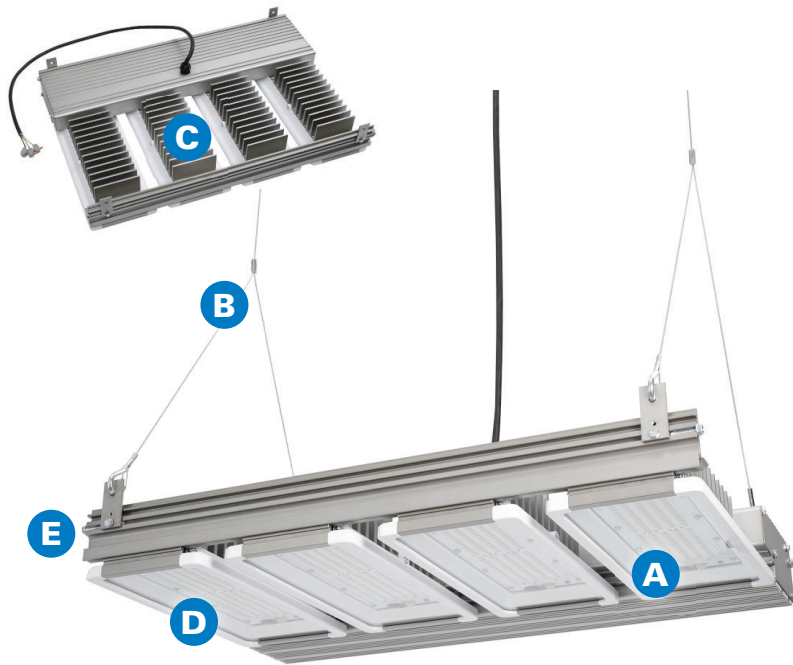
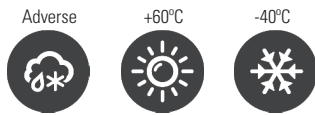

Perfect replacement for 400-1500 watt HID or 4-10 lamp T5HO fixtures

DESIGN FEATURES

- A Increased efficiency** - Up to 117 lumens per watt.
- B Multiple mounting options** - Available with pendant, aircraft cable or jack chain mounting.
- C Aluminum heat sinks for superior thermal management.**
- D Multiple lens options** - Tempered and clear glass standard, diffused glass and clear or diffused polycarbonate options available.
- E Optional occupancy sensor kit available.**



† Operating temperature range may vary by lumen models within a product family. Refer to product catalog pages for complete temperature range details.

* Refer to www.designlights.org Qualified Products List under family models for full listing details. Not all models are approved for all application categories.

Industrial High Bay LED light fixtures

PRIMARY APPLICATIONS

IHB LED luminaires are the perfect replacement for 250W-1,500W HID and 4-10 lamp T5HO fluorescent high bay fixtures. Designed for locations requiring continuous and consistent light levels, requiring frequent on-and-off of lights and that are difficult to relamp or that cause production to be stopped during the lamp maintenance process.

LUMINAIRE MODELS

Model number	Equivalent luminaire	Typical energy savings/lifetime
IHB16L	250-500W HID or 4 lamp T5HO	
IHB24L	400-750W HID or 4-6 lamp T5HO	Up to 72% reduction in energy costs and 60,000 hours of continuous operation!
IHB32L	500-1000W HID or 6-8 lamp T5HO	
IHB48L	750-1,500W HID or 8-10 lamp T5HO	
IHB64L	1,000-1,500W HID or 10 lamp T5HO	

CERTIFICATIONS & COMPLIANCES

- UL1598; UL8750
- cULus
- Damp location
- DesignLights Consortium® approved for select models



ELECTRICAL RATINGS

- Voltages: 100-277 VAC/127-250 VDC, 347-480 VAC
- Input power: 145W, 216W, 289W, 436W, 582W

OPTIONS AND ACCESSORIES

- Occupancy sensor kits
- Diffused or clear lens (glass or polycarbonate)
- Lens guard
- Open ended and closed dust cover kits
- Dimmable driver
- Wide or aisle optic
- Pendant, aircraft cable or jack chain mounting

**U.S. (Global Headquarters):
Eaton's Crouse-Hinds Division**

1201 Wolf Street
Syracuse, NY 13208

(866) 764-5454
FAX: (315) 477-5179

Orders Only:
ECHUSAOOrders@eaton.com

CrouseCustomerCTR@eaton.com

For more information:

If further assistance is required, please contact an authorized Eaton Distributor, Sales Office, or Customer Service Department.

Canada

Toll Free: 800-265-0502
FAX: (800) 263-9504
FAX Orders only: (866) 653-0645

Mexico/Latin America/Caribbean

52-555-804-4000
FAX: 52-555-804-4020
ventascentromex@eaton.com

Europe (Germany)

49 (0) 6271 806-500
49 (0) 6271 806-476
info-ex@eaton.com

Eaton Middle East

9714-8066100
FAX: 9714-8894813
chmesales@eaton.com

Singapore

65-6825-1668
FAX: 65-6645-9811
chsi-sales@eaton.com

China

86-21-2899-3600
FAX: 86-21-2899-4055
echsales@eaton.com

Korea

82 2 6380 4032
82-2-6380-4070
ECHKsales@eaton.com

Australia

1300-332-866
FAX: 61-2-9693-5127
Crousehindsanz@eaton.com

India

91-124-4683888
FAX: 91-124-4683899
cchindia@eaton.com

Eaton
1000 Eaton Boulevard
Cleveland, OH 44122
United States
Eaton.com

Crouse-Hinds Division
1201 Wolf Street
Syracuse, NY 13208
Crouse-Hinds.com

© 2020 Eaton
All Rights Reserved
Printed in USA Publication
No. 5100-1120
November 2020

Eaton is a registered trademark.

All other trademarks are property of their respective owners.