



# Motor Protection Circuit Breaker and Motor Circuit Protector Specifications





Bulletin 140MP, 140MT, 140M

Topic	Page
Summary of Changes	2
Product Line Overview	3
Bulletin 140MP Motor Protection Circuit Breakers	5
Product Overview	5
Group Installation with MPCBs	5
Catalog Number Explanation	6
Product Selection	7
Accessories	8
Specifications	12
MPCB Specifications	12
Application Ratings	13
Accessory Specifications	17
Wiring Diagrams	19
Approximate Dimensions	20
Bulletin 140MT Motor Protective Switching Devices and Motor Circuit Protectors	22
Product Overview	22
Application Diagrams	23
Catalog Number Explanation	25
C- and D-Frame Devices	25
F-Frame Devices	25
Product Selection	26
Selection Using Current and Hp/kW Ratings	26
Selection Using Application Ratings	29
Accessories	34
Specifications	41
Combination Ratings	43
Accessory Specifications	50
Time-Current Characteristic	54
Approximate Dimensions	55
140MT-C, 140MT-D Devices and Accessories	55
140M-F Devices and Accessories	58
Additional Resources	59

## Summary of Changes

This publication contains the following new or updated information. This list includes substantive updates only and is not intended to reflect all changes.

Topic	Page
Expanded Cat. No. explanation for 140-MT C- and D-Frame devices	25
Added coil extension modules to accessory tables for 140-MT	39
Added marking systems to accessory tables for 140-MT	40
Added minimum enclosure size specifications	42
Added Type 2 coordination ratings for 140MT devices with 100-K contactors	44
Added Type 2 coordination ratings for 140MT devices with 100-E contactors	49

				
<b>Bulletin No.</b>	<b>140MP-A</b>	<b>140MT-C</b>	<b>140MT-D</b>	<b>140M-F</b>
Frame Size	–	C-Frame	D-Frame	F-Frame
Max. Current $I_e$	32 A	32 A	40 A	45 A
Current Rating	0.1...32 A	0.1...32 A	0.4...40 A	6.3...45 A
Short-circuit protection	✓	✓	✓	✓
Standard magnetic trip	✓	✓	140MT-D9E...	140M-F8E...
High magnetic trip	–	–	140MT-D9T...	140M-F8T...
Magnetic-only trip (Motor Circuit Protector [MCP])	–	–	140MT-D9N...	140M-F8N...
Overload protection	✓	✓	✓	✓
Trip Class	10A	10	10	10
Phase loss sensitivity	✓	✓	✓	✓
Variable-frequency Drive (VFD) downstream compatible	–	–	140MT-D9V...	✓
<b>UL 60947-4-1 Application Ratings:</b>				
Motor Disconnect	✓ (see ratings)	✓ (see ratings)	✓ (see ratings)	✓ (see ratings)
Group Installation	✓ (see ratings)	✓ (see ratings)	✓ (see ratings)	✓ (see ratings)
Tap Conductor Protection	–	✓ (see ratings)	✓ (see ratings)	✓ (see ratings)
Manual, Self Protected (Type E)	–	✓ (see ratings)	✓ (see ratings)	✓ (see ratings)
Type F ratings with 100-C and 100-E Contactors	–	✓ (see ratings)	✓ (see ratings)	✓ (see ratings)
<b>Standards Compliance and Certifications:</b>				
UL 60947-4-1, CSA C22.2, No. 60947-4-1	✓	✓	✓	✓
IEC/EN 60947-2, IEC/EN 60947-4-1	✓	✓	✓	✓
CE	✓	✓	✓	✓
ATEX	–	✓	✓ <sup>(1)</sup>	–
IECEX	–	✓	✓ <sup>(1)</sup>	–
EAC	✓	✓	✓	✓
CCC	✓	✓	✓	✓
KC	✓	–	–	–
CB Scheme	✓	✓	✓	✓
<b>Accessories (Optional)</b>				
External rotary operator	✓	✓	✓	✓
Auxiliary contacts	✓	✓	✓	✓
Trip Indication contacts	✓	✓	✓	✓
Undervoltage release	✓	✓	✓	✓
Shunt release	✓	✓	✓	✓
Insulated three-phase busbar	✓	✓	✓	✓
Connecting modules for 100-C contactors	✓	✓	✓	✓
Connecting modules for 100-E contactors	✓	✓	✓	–
Connecting modules for 100-K contactors	✓	✓	–	–
Lockable knob	✓	✓	Standard	✓
Anti-tamper cover	✓	✓	Standard	✓
Product Selection	<a href="#">page 7</a>		<a href="#">page 26</a>	

(1) Does not apply to Cat. No. 140MT-D9N... devices.

## Product Overview

Bulletin 140MP Motor Protection Circuit Breakers (MPCBs) or Motor Protective Switching Devices (MPSDs) are UL Listed as Manual Motor Controllers (with approvals for Suitable as Motor Disconnect and Suitable for use in Group Installation).

Group motor installations eliminate the need for individual branch short circuit protective devices for each motor circuit, reducing panel space, installation & wiring time, and costs. There is only one Branch Circuit Protective Device (BCPD) for the "Group".



According to UL 60947-4-1, CSA C22.2 No.60947-4-1, these devices may provide the following control and protection functions.

- Disconnect for Motor Branch Circuit
- Manual Switching (Motor control means)
- Overload Protection (Thermal Protection)

These devices meet requirement of Motor Protective Switching Devices (MPSD) according to IEC 60947-4-1 and Circuit Breaker according to IEC 60947-2 standard for application outside of North America. These devices provide the following functions.

- Disconnect for Motor Branch Circuit
- Short-circuit Protection (Magnetic Protection)
- Overload Protection (Thermal Protection)
- Manual Switching (Motor control means)

140MP devices provide Trip Class 10A overload protection and phase loss sensitivity protection. These are suitable for single- and three-phase application.

## Group Installation with MPCBs

There is only one Branch Circuit Protective Device (BCPD) for the "Group".

Group installation has been successfully used for many years in the U.S. and Canada. It allows "two or motors or one or more motors and other loads to be connected to the same branch-circuit..." The most restrictive part of the conditions specified for Group Installation is the requirement for the protection of the conductors for each motor circuit.

[Figure 1](#) shows an example that illustrates installations involving multiple motors with a single BCPD protecting the entire "Group".

**Bulletin 140MP Motor Protection Circuit Breakers are UL/CSA Listed for Group Installation:** conductors from the BCPD to each motor must be a minimum of 1/3 the ampacity of the Branch Circuit conductors.

Figure 1 - Group Installation with MPCBs

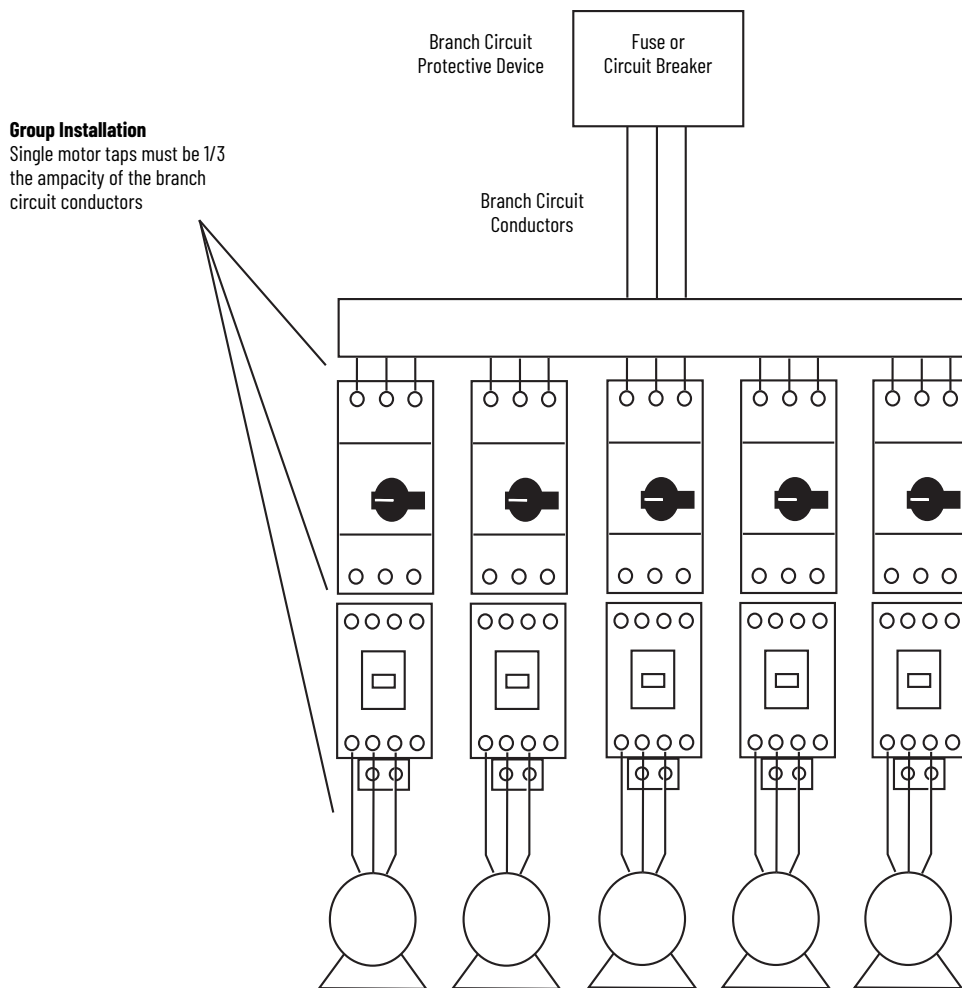

## Catalog Number Explanation

140MP
-
A
3
-
E
-
B10

a
b
c
d
e

a	
Bulletin Number	
Code	Description
140MP	140MP Motor Protection Circuit Breaker

b	
Frame Size	
Code	Description
A	Frame A

c	
Interrupting Rating/ Breaking Capacity	
Code	Description
3	Normal break

d	
Function	
Code	Description
E	Adjustable Thermal/ Fixed Magnetic MPCB

e	
Current Range	
Code	Description
A	0.10 (example: A16 = 0.16 A)
B	1.0 (example: B16 = 1.6 A)
C	10 (example: C16 = 16 A)

# Product Selection

Table 1 - Bulletin 140MP MPCB Selection Using Current and Hp/kW Ratings

Rated Operational Current ( $I_e$ ) [A]	Motor Current Adjustment Range [A]	Nominal Magnetic Trip Current [A]	Max. Short Circuit Current [kA]		Max. 3-phase Hp Ratings <sup>(1)</sup>				Max. kW, 3-Phase – AC-3 <sup>(1)</sup>				Cat. No.
			400V	480V	200V	230V	460V	575V	230V	400/415V	500V	690V	
			( $I_{cu}$ )	(group motor)									
0.16	0.10...0.16	2	100	30	–	–	–	–	–	0.02	0.06	0.06	140MP-A3E-A16
0.25	0.16...0.25	3.1	100	30	–	–	–	–	–	0.04	0.09	0.09	140MP-A3E-A25
0.4	0.25...0.40	5	100	30	–	–	–	0.25	0.06	0.09	0.12	0.18	140MP-A3E-A40
0.63	0.40...0.63	7.9	100	30	–	–	0.25	0.33	0.09	0.18	0.18	0.25	140MP-A3E-A63
1	0.63...1.0	12.5	100	30	–	–	0.5	0.75	0.18	0.25	0.37	0.55	140MP-A3E-B10
1.6	1.0...1.6	20	100	30	0.25	0.33	1	1	0.25	0.55	0.75	1.1	140MP-A3E-B16
2.5	1.6...2.5	31.3	75	30	0.5	0.75	1.5	2	0.37	0.75	1.1	1.8	140MP-A3E-B25
4	2.5...4.0	50	75	18	1	1	3	3	0.75	1.5	2.2	3	140MP-A3E-B40
6.3	4.0...6.3	78.8	50	18	1.5	2	5	5	1.5	2.2	3	4	140MP-A3E-B63
10	6.3...10	150	50	18	3	3	7.5	10	2.2	4	6.3	7.5	140MP-A3E-C10
12	8.0...12	180	50	18	3	3	7.5	10	3	5.5	6.3	7.5	140MP-A3E-C12
16	10...16	240	15	18	5	5	10	15	4	7.5	10	13	140MP-A3E-C16
20	16...20	300	15	18	5	7.5	15	20	5.5	10	11	17	140MP-A3E-C20
25	20...25	375	15	18	7.5	7.5	20	20	5.5	11	15	22	140MP-A3E-C25
32	25...32	480	15	18	7.5	10	25	30	7.5	15	20	25	140MP-A3E-C32

(1) Horsepower/kW ratings shown are for reference. The final selection of the MPCB/MPSD depends on the actual motor full load current.

Table 2 - Bulletin 140MP MPCB Selection Using Interrupting Rating/Breaking Capacity

Breaking Capacity, IEC 60947-2															Cat. No.			
230V AC			400V AC			440V AC			500V AC			690V AC						
$I_{cs}$ [kA]	$I_{cu}$ [kA]	Back-up Fuse Rating <sup>(1)</sup> [A]	$I_{cs}$ [kA]	$I_{cu}$ [kA]	Back-up Fuse Rating <sup>(1)</sup> [A]	$I_{cs}$ [kA]	$I_{cu}$ [kA]	Back-up Fuse Rating <sup>(1)</sup> [A]	$I_{cs}$ [kA]	$I_{cu}$ [kA]	Back-up Fuse Rating <sup>(1)</sup> [A]	$I_{cs}$ [kA]	$I_{cu}$ [kA]	Back-up Fuse Rating <sup>(1)</sup> [A]				
50	100	_ (2)	50	100	_ (2)	30	100	_ (2)	30	100	_ (2)	30	100	_ (2)	140MP-A3E-A16			
50	100		50	100		30	100		30	100		30	100		30	100	140MP-A3E-A25	
50	100		50	100		30	100		30	100		30	100		30	100	140MP-A3E-A40	
50	100		50	100		30	100		30	100		30	100		30	100	140MP-A3E-A63	
50	100		50	100		30	100		30	100		30	100		30	100	140MP-A3E-B10	
50	100		50	100		30	100		30	100		30	100		30	100	140MP-A3E-B16	
50	75		50	75		10	30		25 <sup>(3)</sup>	10		20	25 <sup>(3)</sup>		5	10	25 <sup>(3)</sup>	140MP-A3E-B25
50	75		50	75		6	18		25 <sup>(3)</sup>	6		15	25 <sup>(3)</sup>		2	3	25 <sup>(3)</sup>	140MP-A3E-B40
50	50		50	50		6	18		63 <sup>(3)</sup>	6		10	63 <sup>(3)</sup>		2	3	40 <sup>(3)</sup>	140MP-A3E-B63
50	50		50	50		6	18		63 <sup>(3)</sup>	6		10	63 <sup>(3)</sup>		2	3	50 <sup>(3)</sup>	140MP-A3E-C10
25	50	80 <sup>(3)</sup>	25	50	80 <sup>(3)</sup>	6	15	63 <sup>(3)</sup>	6	10	63 <sup>(3)</sup>	2	3	50 <sup>(3)</sup>	140MP-A3E-C12			
15	15	80 <sup>(3)</sup>	15	15	80 <sup>(3)</sup>	4	6	63 <sup>(3)</sup>	4	6	63 <sup>(3)</sup>	2	3	63 <sup>(3)</sup>	140MP-A3E-C16			
10	15	125 <sup>(3)</sup>	10	15	125 <sup>(3)</sup>	3	6	125 <sup>(3)</sup>	3	6	125 <sup>(3)</sup>	2	3	80 <sup>(3)</sup>	140MP-A3E-C20			
10	15	125 <sup>(3)</sup>	10	15	125 <sup>(3)</sup>	3	6	125 <sup>(3)</sup>	3	6	125 <sup>(3)</sup>	2	3	100 <sup>(3)</sup>	140MP-A3E-C25			
10	15	125 <sup>(3)</sup>	10	15	125 <sup>(3)</sup>	3	6	125 <sup>(3)</sup>	3	6	125 <sup>(3)</sup>	2	3	100 <sup>(3)</sup>	140MP-A3E-C32			

(1) Back-up fuses are type gG, aM.

(2) No Back-up fuse required if  $I_{cc} < I_{cs}$ .

(3) Rated back-up fuse for short-circuit up to 50 kA.

# Accessories

Table 3 - Auxiliary Contacts



Description	Auxiliary Contacts		Connection Diagram	Pkg. Qty.	Cat. No.
	N.O	N.C			
 <p>Front-mounted Auxiliary Contact</p> <ul style="list-style-type: none"> <li>No additional space required</li> <li>1 and 2-pole</li> </ul>	1	1		10	140MP-A-AFA11
	1	0			140MP-A-AFA10
	0	1			140MP-A-AFA01
	2	0			140MP-A-AFA20
 <p>Right-side-mounted Auxiliary Contact</p> <ul style="list-style-type: none"> <li>2-pole</li> <li>Adds 9 mm (0.35 in.) to the width of the Manual Motor Starter</li> <li>Use compact bus bars with 54 mm (2.13 in.) spacing</li> </ul>	1	1		2	140MP-A-ASA11
	2	0			140MP-A-ASA20
	0	2			140MP-A-ASA02
	Lead Contacts				140MP-A-ASA20L

Table 4 - Trip Contacts

Description	Auxiliary Contacts		Connection Diagram	Pkg. Qty.	Cat. No.
	N.O	N.C			
 <p>Right-side-mounted Trip Signaling Contact</p> <ul style="list-style-type: none"> <li>2-pole</li> <li>Adds 9 mm (0.35 in.) to the width of the Manual Motor Starter</li> <li>Use compact bus bars with 54 mm (2.13 in.) spacing</li> </ul>	1	1		2	140MP-A-ASAR11
	2	0			140MP-A-ASAR20
	0	2			140MP-A-ASAR02

Table 5 - Undervoltage and Shunt Trip Units

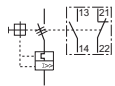
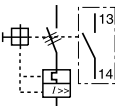
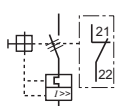
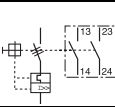

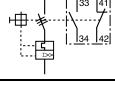
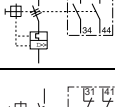
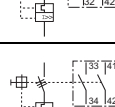
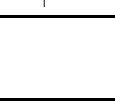
Description		Trip Rating	Connection Diagram	Pkg. Qty.	Cat. No.
 <p>Undervoltage Trip Release</p> <ul style="list-style-type: none"> <li>• Left-side mounted</li> <li>• Adds 18 mm (0.71 in.) to the width of the Manual Motor Starter</li> </ul>		20V, 50 Hz/ 24V, 60 Hz		1	140MP-A-UXJ
		24V, 50 Hz			140MP-A-UXK
		48V, 50 Hz			140MP-A-UXY
		60V, 50 Hz			140MP-A-UXYA
		110V, 50 Hz/ 120V, 60 Hz			140MP-A-UXC
		208V, 60 Hz			140MP-A-UXH
		230V, 50 Hz/ 240V, 60 Hz			140MP-A-UXF
		400V, 50 Hz			140MP-A-UXN
		415V, 50 Hz/ 480V, 60 Hz			140MP-A-UXB
		575V, 60 Hz			140MP-A-UXM
 <p>Shunt Trip Release</p> <ul style="list-style-type: none"> <li>• Left-side mounted</li> <li>• Adds 18 mm (0.71 in.) to the width of the Manual Motor Starter</li> </ul>		20...24V, 50/60 Hz		1	140MP-A-SNKJ
		110V, 50/60 Hz			140MP-A-SND
		200...240V, 50/60 Hz			140MP-A-SNAF
		350...415V, 50/60 Hz			140MP-A-SNN

Table 6 - Bus Bars

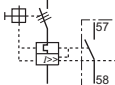
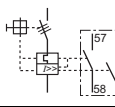
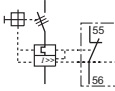

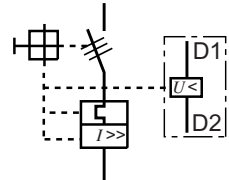

Description		Terminal Links	For Use With	Pkg. Qty.	Cat. No.
 <p>Compact Bus Bars</p> <ul style="list-style-type: none"> <li>- UL: 600V, 60 A</li> <li>- IEC: 690V, 65 A</li> </ul>	<ul style="list-style-type: none"> <li>• 45 mm (1.77 in.) spacing</li> <li>• For use with front-mounted auxiliary contact</li> </ul>	2 x 3 connections	140MP	10	140MP-A-W452
		3 x 3 connections			140MP-A-W453
		4 x 3 connections			140MP-A-W454
		5 x 3 connections			140MP-A-W455
	<ul style="list-style-type: none"> <li>• 54 mm (2.13 in.) spacing</li> <li>• For use with side-mounted auxiliary contact</li> </ul>	2 x 3 connections	140MP	10	140MP-A-W542
		3 x 3 connections			140MP-A-W543
		4 x 3 connections			140MP-A-W544
		5 x 3 connections			140MP-A-W545
	<ul style="list-style-type: none"> <li>• 63 mm (2.5 in.) spacing</li> <li>• For use with side-mounted auxiliary contact</li> </ul>	2 x 3 connections	140MP	10	140MP-A-W632
		3 x 3 connections			140MP-A-W633
		4 x 3 connections			140MP-A-W634
		5 x 3 connections			140MP-A-W635
 <p>Bus Bar Feeder Terminal (Flat)</p> <ul style="list-style-type: none"> <li>• Supply of compact bus bars</li> <li>• Increases terminal capacity</li> </ul>			140MP-A-W	10	140MP-A-WTN
	<p>Bus Bar Feeder Terminal (High)</p> <ul style="list-style-type: none"> <li>• Supply of compact bus bars</li> <li>• Increases terminal capacity</li> </ul>			140MP-A-W	10

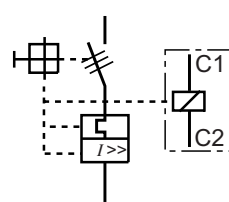
Table 7 - Connecting Modules

Description	For Use With	Cat. No.
 <p>ECO Connecting Module - 12 A (IEC), 11 A (UL)</p> <ul style="list-style-type: none"> <li>• For DOL Starters</li> <li>• ECO Starters mount on single DIN Rail (140MP on DIN rail)</li> <li>• Electrical and mechanical interconnection of 140MP and 100-K Contactors</li> </ul>	140MP-A to 100-K	140MP-A-PEK12
 <p>ECO Connecting Module - 25 A (IEC), 24 A (UL)</p> <ul style="list-style-type: none"> <li>• For DOL Starters</li> <li>• ECO Starters mount on single DIN Rail (140MP on DIN rail)</li> <li>• Electrical and mechanical interconnection of 140MP and 100-C Contactors</li> </ul>	140MP-A to 100-C09...C23	140MP-A-PEC23



**Table 7 - Connecting Modules (Continued)**



Description		For Use With	Cat. No.
 <p>ECO Connecting module <sup>(1)</sup></p> <ul style="list-style-type: none"> <li>For DDL starters</li> <li>ECO Starters mount on single DIN Rail (140MP on DIN Rail)</li> <li>Electrical and mechanical interconnection of 140MP and 100-E contactors</li> <li>Package quantity: 10</li> </ul>	16 A	140MP-A3E-A16...C25 to 100(S)-E09...16	140MP-A-PE16
		140MP-A3E-A16...C16 to 100(S)-E26...38	140MP-A-PE26
	38 A	140MP-A3E-C20...C32 to 100(S)-E26...38	140MP-A-PE38

(1) Not suitable for 100(S)-E09...380J or 300(S)-T0...B00J contactors.

**Table 8 - Additional Accessories**

Description		For Use With	Pkg. Qty.	Cat. No.
 <p>Blank Space Cover</p> <ul style="list-style-type: none"> <li>For covering unused terminal links</li> <li>Must be ordered in multiples of 10 (10pieces/package)</li> </ul>	140MP-A-W	50	140MP-A-WSN	
 <p>Screw Adapter</p> <ul style="list-style-type: none"> <li>For screw arrangement of a motor protection circuit breaker</li> <li>Hat (DIN) Rail 35 x 7.5 mm (1.4 x 0.3 in.)</li> <li>44 mm (1.7 in.) length</li> </ul>	140MP	10	140MP-A-N45	
 <p>Enclosure</p> <ul style="list-style-type: none"> <li>Up to three padlocks in OFF position</li> <li>Protection Class: IP65; UL/CSA Type 12</li> </ul>	Red/yellow handle	140MP	1	140MP-A-ENY65
	Black handle			140MP-A-ENN65
 <p>Door Mounting Kit</p> <ul style="list-style-type: none"> <li>Up to three padlocks in OFF position</li> <li>Protection Class: IP65; UL/CSA Type 12</li> </ul>	Red/yellow handle	140MP	1	140MP-A-DMY65
	Black handle			140MP-A-DMN65
 <p>Door Coupling Handle</p> <ul style="list-style-type: none"> <li>Up to three padlocks in OFF position</li> <li>Defeatable</li> <li>Type 1/3R/12</li> <li>IP64</li> </ul>	Red/Yellow	140MP	1	140MP-A-DCY65
	Black			140MP-A-DC65
 <p>Coupler</p> <ul style="list-style-type: none"> <li>Coded - Positioning of ON indication dependent from mounting orientation of the 140MP</li> <li>Uncoded - Positioning of ON indication independent from mounting orientation of the 140MP</li> </ul>	Driver with screw	140MP	1	140MP-A-DNC
	Driver without coding, with screw			140MP-A-DNUC
 <p>Shaft Alignment Ring</p> <ul style="list-style-type: none"> <li>Supports the long shafts for alignment to the handle inlet. It makes closing panel doors more easy</li> <li>Use for shafts</li> </ul>	140MP	1	140MP-A-SAR	

**Table 8 - Additional Accessories**

Description		For Use With	Pkg. Qty.	Cat. No.	
	Extension Shaft	105 mm (4.13 in.)	140MP	10	140MP-A-DS
		180 mm (7.1 in.)			140MP-A-DSM
	Extension Shaft Support <ul style="list-style-type: none"> <li>• Supports the shaft in the extension of handle (140MP-A-DC)</li> <li>• Required for shaft lengths &gt;130 mm (5.1 in.)</li> <li>• Snaps on the right side of the MPCB</li> <li>• Width: 9 mm (0.35 in.)</li> <li>• For use with screw-mounted or hat rail mounted devices.</li> </ul>	140MP	1	140MP-A-SHS	
	Lockable Handle Accessory <ul style="list-style-type: none"> <li>• For locking 140MP devices in the OFF position</li> </ul>	140MP	10	140MP-A-KN1	

# Specifications

## MPCB Specifications

**Table 9 - General Ratings**

Attribute		Value
Standards compliance	IEC	IEC/EN 60947-2, IEC/EN 60947-4-1, IEC/EN 60947-1
	cULus	UL 60947-1, UL 60947-4-1, CSA C22.2, No. 60947-4-1
Certifications	Global	RINA (Marine)
	Regional	CCC, KC, EAC, CE, IEC, cULus, CB Scheme
Rated operating voltage $U_e$		690V AC
Maximum operating voltage (UL)		600V
Rated Frequency		50/60 Hz
Trip Class		10A
Number of operations	Mechanical	100.000 Cycles
	Electrical	100,000 Cycles (0.1...16 A); 50,000 Cycles (20...32 A)
Rated impulse withstand voltage $U_{imp}$		6 kV
Rated insulation voltage $U_i$		690V
Pollution Degree		3
Phase loss sensitivity		Yes
Disconnect function per IEC/EN 60947-2		Yes
Resistance to shock per IEC 60068-2-27		25 G/11 ms
Resistance to vibrations per IEC 60068-2-6		5 G /3 ... 150 Hz
Mounting		DIN Rail (EN 60715)
Group mounting (side by side)		up to 40 °C (104 °F)
Minimum distance to other units same type	Horizontal	0 mm (0 in.)
	Vertical	150 mm (5.9 in.)
Minimum distance to electrical conductive board	Horizontal, up to 400V	0 mm (0 in.)
	Horizontal, up to 690V	> 1.5 mm (0.06 in.)
	Vertical	75 mm (2.96 in.)
Degree of Protection	Housing	IP20
	Main Terminals	IP10
Short-circuit ratings	@230V, 400V, 440V, 500V, and 690V	See <a href="#">Table 2</a>
	@480V and 600V—for motor disconnect	See <a href="#">Table 14</a>
	@480V and 600V—for group motor installation	
Utilization Category	IEC 60947-2 (Circuit breaker)	A
	IEC 60947-4-1 (Motor Starter)	AC-3

**Table 10 - Power Loss**

Power Loss	Rated Operating Current [A]	Rated Operating Current [A]				
		0.16...1.6	2.5...6.3	10...12	16...25	32
Power Loss in all 3 Poles up to: [W]		5.1	5.4	7.2	8.4	9.3

**Table 11 - Environmental Ratings**





Attribute		Value
Operating Ambient air temperature	Open—compensated	-25 ... +55 °C (-13...+131 °F) <sup>(1)</sup>
	Open	-25 ... +70 °C (-13...+158 °F) <sup>(1)</sup>
	Enclosed	0 ... +40 °C (32...104 °F)
Storage Ambient air temperature		-50 ... +80 °C (-58...+176 °F)
Maximum operating altitude permissible		2000 m (6561 ft)

(1) With derating. See [Table 12](#).

**Table 12 - Ambient Temperature Derating**

Cat. No.	Ambient Temperature Derating [A]		
	40 °C (104 °F)	55 °C (131 °F)	70 °C (158 °F)
140MP-A3E-C10	10	10	8
140MP-A3E-C12	12	12	10
140MP-A3E-C16	16	16	12
140MP-A3E-C20	20	20	18
140MP-A3E-C25	25	25	23
140MP-A3E-C32	32	32	29

**Table 13 - MPCB Connecting Characteristics**

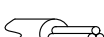
Connection		No. of Conductors	Devices Rated ≤ 16 A	Devices Rated 20...32 A
Type of terminals				
Connection Screw			M3.5/Pozidriv No.2	M4/Pozidriv No.2
Wiring	Solid	 1 or 2	1...4 mm <sup>2</sup>	1...2.5 mm <sup>2</sup> 2.5...6 mm <sup>2</sup>
	Flexible with ferrule	 1 or 2	0.75...2.5 mm <sup>2</sup>	0.75...6 mm <sup>2</sup>
	Flexible/finely stranded	 1 or 2	0.75...2.5 mm <sup>2</sup> /No. 16...12 AWG	1.5...2.5 mm <sup>2</sup> /No.16...8 AWG 2.5...6 mm <sup>2</sup> /No.16...8 AWG
	Stranded per UL/CSA	 1 or 2	1...4 mm <sup>2</sup> /No. 16...12 AWG	1...2.5 mm <sup>2</sup> /No.16...8 AWG 2.5...6 mm <sup>2</sup> /No.16...8 AWG
	Stripping length		9 mm (0.35 in.)	10 mm (0.39 in.)
Tightening torques			0.8...1.2 N•m/7...10 lb•in	2 N•m /18 lb•in

## Application Ratings

Table 14 lists specific application ratings for MPCBs.

**Table 14 - UL/CSA Listed Application Ratings, Motor Protection Circuit Breaker Only**

Cat. No.	Branch Circuit Protection Max. Size per NEC/CEC [A]	UL 60947-4-1 – Manual Motor Controller			
		Max. Short Circuit Current [kA]			
		Motor Disconnect		Group Installation	
		480V	600V	480V	600V
140MP-A3E-A16	175	30	5	30	5
140MP-A3E-A25	175	30	5	30	5
140MP-A3E-A40	175	30	5	30	5
140MP-A3E-A63	175	30	5	30	5
140MP-A3E-B10	175	30	5	30	5
140MP-A3E-B16	175	30	5	30	5
140MP-A3E-B25	175	30	5	30	5
140MP-A3E-B40	175	18	5	18	5
140MP-A3E-B63	175	18	5	18	5
140MP-A3E-C10	175	18	5	18	5
140MP-A3E-C12	175	18	5	18	5
140MP-A3E-C16	175	18	5	18	5
140MP-A3E-C20	400	18	5	18	5
140MP-A3E-C25	400	18	5	18	5
140MP-A3E-C32	400	18	5	18	5

Table 15 through Table 20 lists specific application ratings for MPCBs in combination with Bulletin 100-K, 100-C, and 100-E contactors.

**Type 1 Coordination**—Specified 100-K contactors are suitable for motor group applications when they are used on the load side of the 140MP-A3E Manual Motor Controllers that are specified in Table 15.

**Table 15 - Type 1 Application Ratings, 140MP to 100-K Miniature IEC Contactors**

Manual Motor Controller	Contactor <sup>(1)</sup>	SCCR		
		480V AC [kA]	600V AC [kA]	Maximum Fuse or Circuit Breaker sized per NEC [A]
140MP-A3E-A16	100-K05 100-K09 100-K12	30	5	175
140MP-A3E-A25		30	5	175
140MP-A3E-A40		30	5	175
140MP-A3E-A63		30	5	175
140MP-A3E-B10		30	5	175
140MP-A3E-B16		30	5	175
140MP-A3E-B25		30	5	175
140MP-A3E-B40		18	—	175
140MP-A3E-B63		18	—	175
140MP-A3E-C10		100-K09 100-K12	18	—
140MP-A3E-C12	100-K12	18	—	175
140MP-A3E-C16		18	—	175

(1) May be used with 140MP-A-PEK12 connecting module between 140MP-A3E manual motor controller and 100-K contactor.

**Type 1 Coordination**—Specified 100-C contactors (without R suffix) are suitable for motor group applications when they are used on the load side of the specified Manual Motor Controllers.

**Table 16 - Type 1 Application Ratings, 140MP to 100-C IEC Contactors**

Manual Motor Controller	Contactor <sup>(1)</sup>	SCCR		
		480V AC [kA]	600V AC [kA]	Maximum Fuse or Circuit Breaker sized per NEC [A]
140MP-A3E-A16	100-C09 100-C12 100-C16 100-C23	30	5	175
140MP-A3E-A25		30	5	175
140MP-A3E-A40		30	5	175
140MP-A3E-A63		30	5	175
140MP-A3E-B10		30	5	175
140MP-A3E-B16		30	5	175
140MP-A3E-B25		30	5	175
140MP-A3E-B40		18	5	175
140MP-A3E-B63		18	5	175
140MP-A3E-C10		18	5	175
140MP-A3E-C12	100-C12 100-C16 100-C23	18	5	175
140MP-A3E-C16 <sup>(2)</sup>	100-C16, 100-C23	18	5	175
140MP-A3E-C20	100-C23 100-C30 100-C37	18	5	400
140MP-A3E-C25 <sup>(3)</sup>	100-C23	18	—	400
140MP-A3E-C25 <sup>(3)</sup>	100-C30, 100-C37	18	5	400
140MP-A3E-C32 <sup>(4)</sup>	100-C30, 100-C37	18	5	400

(1) 140MP-A-PEC23 connection modules may be used with 100-C09...-C23 up to 24 A.

(2) Limited to 15.5 FLA maximum when used in a 365 x 235 x 140 mm (14.4 x 9.3 x 5.5 in.) (200%) or larger enclosure. Limited to 14.5 FLA maximum when used in 115 x 290 x 180 mm (4.5 x 11.4 x 7.1 in.) (150%) minimum sized enclosure.

(3) Minimum enclosure size is 170 x 670 x 235 mm (6.7 x 26.4 x 9.3 in.) (250%) at full load current. If end use current is 22.5 FLA or less, may be used in an enclosure as small as 115 x 290 x 180 mm (4.5 x 11.4 x 7.1 in.) (150%).

(4) May be used at 30.8 FLA maximum when used ambient temperature of 40 °C (104 °F) maximum. May be used up to 29 FLA when used in a 115 x 290 x 180 mm (4.5 x 11.4 x 7.1 in.) (150%) minimum size enclosure.

**Table 17 - Type 2 Coordination Ratings per IEC 60947-4-1, 140MP to 100-C IEC Contactors, Standard Motor Protection**

Cat. No.	Type 2 Coordination Ratings, IEC 60947-4-1	
	400/415V	
	Max. Short Circuit Current [kA]	For Use With Contactor Cat. No.
140MP-A3E-A16	50	100-C09
140MP-A3E-A25	50	100-C09
140MP-A3E-A40	50	100-C09
140MP-A3E-A63	50	100-C09
140MP-A3E-B10	50	100-C09
140MP-A3E-B16	50	100-C09
140MP-A3E-B25	50	100-C09
140MP-A3E-B40	50	100-C09
140MP-A3E-B63	50	100-C09
140MP-A3E-C10	50	100-C09
140MP-A3E-C12	25	100-C12
140MP-A3E-C16	10	100-C23
140MP-A3E-C20	10	100-C30
140MP-A3E-C25	10	100-C30
140MP-A3E-C32	10	100-C30

**Table 18 - Type 2 Coordination Ratings per IEC 60947-4-1, 140MP to 100-E IEC Contactors, Standard Motor Protection**

Cat. No.	Type 2 Coordination Ratings, IEC 60947-4-1	
	400V	
	Max. Short Circuit Current [kA]	Minimum Contactor Size
140MP-A3E-A16	50	100-E09
140MP-A3E-A25	50	100-E09
140MP-A3E-A40	50	100-E09
140MP-A3E-A63	50	100-E09
140MP-A3E-B10	50	100-E09
140MP-A3E-B16	50	100-E09
140MP-A3E-B25	50	100-E09
140MP-A3E-B40	50	100-E26
140MP-A3E-B63	50	100-E26
140MP-A3E-C10	50	100-E26
140MP-A3E-C12	25	100-E26
140MP-A3E-C16	16	100-E26
140MP-A3E-C20	10	100-E30
140MP-A3E-C25	10	100-E30
140MP-A3E-C32	10	100-E38

Table 19 - Type 2 Coordination Ratings per UL 60947-4-1, 140MP to 100-C IEC Contactors, Standard Motor Protection

Cat. No.	Contactor <sup>(1)</sup>	Type 2 Coordination Ratings, UL 60947-4-1		Max. Fuse or Circuit Breaker Size per NEC [A]
		480V	600V	
		Max. Short Circuit Current [kA]	Max. Short Circuit Current [kA]	
140MP-A3E-A16	100-C09 100-C12 100-C16 100-C23	30	5	175
140MP-A3E-A25		30	5	175
140MP-A3E-A40		30	5	175
140MP-A3E-A63		30	5	175
140MP-A3E-B10		30	5	175
140MP-A3E-B16		30	5	175
140MP-A3E-B25		100-C12 100-C16 100-C23	30	5
140MP-A3E-B40	100-C16 100-C23	18	5	175
140MP-A3E-B63	100-C23	18	5	175
140MP-A3E-C10	100-C30 100-C37	18	5	175
140MP-A3E-C12		18	5	175
140MP-A3E-C16 <sup>(2)</sup>		18	5	175
140MP-A3E-C20		18	5	400
140MP-A3E-C25 <sup>(3)</sup>		18	5	400
140MP-A3E-C32 <sup>(4)</sup>		18	5	400

(1) 140MP-A-PEC23 connection modules may be used with 100-C09...-C23 up to 24 A.

(2) Limited to 15.5 FLA maximum when used in a 365 x 235 x 140 mm (14.4 x 9.3 x 5.5 in.) (200%) or larger enclosure.  
Limited to 14.5 FLA maximum when used in 115 x 290 x 180 mm (4.5 x 11.4 x 7.1 in.) (150%) minimum sized enclosure.

(3) Minimum enclosure size is 170 x 670 x 235 mm (6.7 x 26.4 x 9.3 in.) (250%) at full load current.  
If end use current is 22.5 FLA or less, may be used in an enclosure as small as 115 x 290 x 180 mm (4.5 x 11.4 x 7.1 in.) (150%).

(4) May be used at 30.8 FLA maximum when used ambient temperature of 40 °C (104 °F) maximum.  
May be used up to 29 FLA when used in a 115 x 290 x 180 mm (4.5 x 11.4 x 7.1 in.) (150%) minimum size enclosure.

Table 20 - Type 2 Coordination Ratings per UL 60947-4-1, 140MP to 100-E IEC Contactors, Standard Motor Protection

Cat. No.	Max. Fuse or Circuit Breaker per NEC	Type 2 Coordination Ratings, UL 60947-4-1			
		480V		600V	
		Max. Short-circuit Current [kA]	Minimum Contactor Size	Max. Short-circuit Current [kA]	Minimum Contactor Size
140MP-A3E-A16	175	30	100-E09	5	100-E09
140MP-A3E-A25	175	30	100-E09	5	100-E09
140MP-A3E-A40	175	30	100-E09	5	100-E09
140MP-A3E-A63	175	30	100-E09	5	100-E09
140MP-A3E-B10	175	30	100-E09	5	100-E09
140MP-A3E-B16	175	30	100-E09	5	100-E09
140MP-A3E-B25	175	30	100-E16	5	100-E16
140MP-A3E-B40	175	18	100-E26	5	100-E16
140MP-A3E-B63	175	18	100-E26	5	100-E26
140MP-A3E-C10	175	18	100-E26	5	100-E30
140MP-A3E-C12	175	18	100-E26	5	100-E30
140MP-A3E-C16	175	18	100-E26	5	100-E40
140MP-A3E-C20	400	18	100-E26	5	100-E40
140MP-A3E-C25	400	18	100-E30	5	100-E40
140MP-A3E-C32	400	18	100-E38	5	100-E40

## Accessory Specifications

**Table 21 - Auxiliary Contact, Signaling Contact, and Short-circuit Signaling Contact Specifications**

Attribute		Side-mounted Auxiliary, Signaling, and Short-circuit Signaling Contacts	Front-mounted Auxiliary Contacts
Standards compliance	IEC	IEC/EN 60947-1, IEC/EN 60947-5-1	IEC/EN 60947-1, IEC/EN 60947-5-1
	UL/cULus	UL 60947-4-1, CAN/CSA22.2 No. 60947-4-1	UL 60947-4-1, CAN/CSA22.2 No. 60947-4-1
Rated operating voltage $U_e$		690V AC/600V DC	250V AC/250V DC
Conventional free-air thermal current $I_{th}$		6 A	5 A
Rated Frequency		50/60 Hz	50/60 Hz
Rated impulse withstand voltage $U_{imp}$		6 kV	6 kV
Rated insulation voltage $U_i$		690V AC	250V AC
Pollution Degree		3	3
Ambient air temperature	Operation	-25 ... +60 °C (-13...+140 °F)	-25 ... +60 °C (-13...+140 °F)
	Storage	-50 ... +80 °C (-58...+176 °F)	-50 ... +80 °C (-58...+176 °F)
Resistance to shock per IEC 60068-2-27		25 G/11 ms	25 G/11 ms
Resistance to vibrations per IEC 60068-2-6		5 G/3 ... 150 Hz	5 G/3 ... 150 Hz
Rated operational current $I_e$ AC-15 per IEC/EN 60947-5-1 for utilization category	24V, 120V	6 A	3 A
	240V	4 A	1.5 A
	400V	3 A	—
	440V, 690V	1 A	—
Rated operational current $I_{eDC}$ -13 per IEC/EN 60947-5-1 for utilization category	24V	2 A	1 A
	125V	0.55 A	0.27 A
	250V	0.27 A	0.11 A
	440V, 600V	0.15 A	—
Minimum switching capacity		17V DC/5 mA	17V DC/5 mA
Short-circuit protective device (N.O, N.C)		10 A Type gG	10 A Type gG
Duty time		100%	100%
Mounting		Right side	Front
Number of operations	Mechanical	50,000 cycles	50,000 cycles
	Electrical		
<b>Contact utilization characteristics according to UL/CSA</b>			
Rated operating voltage $U_e$ per UL/CSA		600V AC/600V DC	250V AC/250V DC
Pilot duty		B600, Q600	B300, R300
AC thermal rated current		5 A	5 A
AC maximum volt-ampere	making	3600	3600 VA
	breaking	360	360 VA
DC thermal rated current		2.5 A	2.5 A
DC maximum volt-ampere	making	69 VA	28 VA
	breaking		
Connecting characteristics		<a href="#">Table 24</a>	<a href="#">Table 24</a>







**Table 22 - Undervoltage Release Specifications**

Attribute		Value
Standards compliance	IEC	IEC/EN 60947-1, IEC/EN 60947-5-1
	UL/cULus	UL 60947-4-1, CAN/CSA22.2 No. 60947-4-1
Rated control supply voltage		See <a href="#">Table 5</a>
Rated frequency		
Operating voltage	Tripping	0.35 ... 0.7 x U <sub>s</sub>
	Coil	0.85 ... 1.1 x U <sub>s</sub>
Rated impulse withstand voltage U <sub>imp</sub>		6 kV
Rated insulation voltage U <sub>i</sub>		690V
Pollution degree		3
Ambient air temperature	Operation	-25 ... +60 °C (-13...+140 °F)
	Storage	-50 ... +80 °C (-58...+176 °F)
Resistance to shock per IEC 60068-2-27		25 G/11 ms
Resistance to vibrations per IEC 60068-2-6		5 G/3 ... 150 Hz
Mounting		left side of MPCB

**Table 23 - Shunt Trip Specifications**

Attribute		Value
Standards compliance	IEC	IEC/EN 60947-1, IEC/EN 60947-5-1
	UL/cULus	UL 60947-4-1, CAN/CSA22.2 No. 60947-4-1
Rated control supply voltage		See <a href="#">Table 5</a>
Rated frequency		
Operating voltage	Tripping	0.7 ... 1.1 x U <sub>s</sub>
Rated impulse withstand voltage U <sub>imp</sub>		6 kV
Rated insulation voltage U <sub>i</sub>		690V
Pollution degree		3
Ambient air temperature	Operation	-25 ... +60 °C (-13...+140 °F)
	Storage	-50 ... +80 °C (-58...+176 °F)
Resistance to shock per IEC 60068-2-27		15 G/11ms
Resistance to vibrations per IEC 60068-2-6		5 G/3 ... 150 Hz
Mounting		left side of MPCB





**Table 24 - Auxiliary Contact Connecting Characteristics**

Connection		No. of Conductors	Side Mounted	Front Mounted
Wiring	Solid 	1 or 2	1...1.5 mm <sup>2</sup>	1...2.5 mm <sup>2</sup>
	Flexible with ferrule 	1 or 2	0.75...1.5 mm <sup>2</sup>	
	Flexible 	1 or 2	0.75...1.5 mm <sup>2</sup>	
	Stranded per UL/CSA 	1 or 2	No. 16...14 AWG	
	Stripping length		8 mm (0.31 in.)	
Tightening torques			0.8...1.2 N•m/7 lb•in	
Recommended screwdriver			Pozidriv No.2	

**Table 25 - Feeder Terminal and Bus Bar Current Ratings**

Attribute	140MP-A-W45..., -W54..., -W63...	140MP-A-WT...
Rated operational voltage $U_e$	690V	
Rated operational voltage $U_e$ per UL/CSA	600V AC	
Rated operational current $I_e$	65 A	
Rated operational current $I_e$ per UL/CSA	60 A	65 A
Suitable for enclosure size (UL)	200% of Size of 140MP-A with bus bars	
Rated frequency	50/60 Hz	
Rated impulse withstand voltage $U_{imp}$	6 kV	
Rated insulation voltage $U_i$	690V AC	

**Table 26 - Main Circuit Connecting Characteristics**

Connection		No. of Conductors	Value
Wiring	Solid 	1	6...25 mm <sup>2</sup>
	Flexible with ferrule 	1	6...16 mm <sup>2</sup>
	Flexible with insulated ferrule 	1	6...16 mm <sup>2</sup>
	Flexible 	1	6...16 mm <sup>2</sup>
	Stranded per UL/CSA 	1	No. 10...4 AWG
	Stripping length		
Tightening torques			2.5 N•m/22 lb•in
Recommended screwdriver			Pozidriv No.2

## Wiring Diagrams

Figure 2 illustrates basic wiring for the 140MP MPCB and accessories.

**Figure 2 - 140MP Wiring Example**

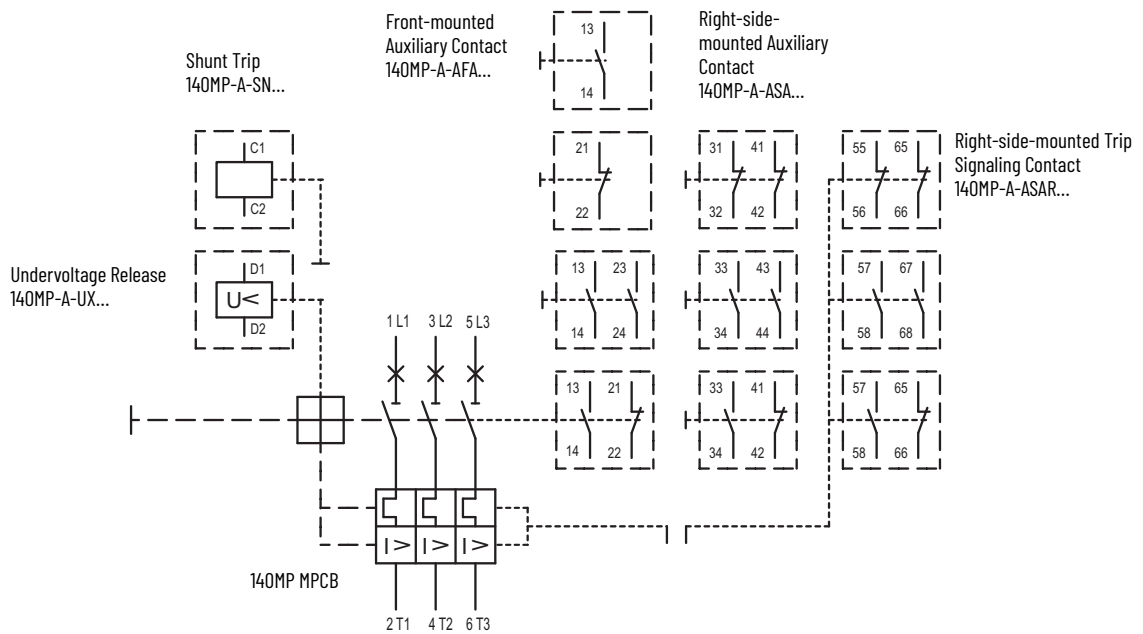

## Approximate Dimensions

Dimensions are in millimeters (inches) and are not intended for manufacturing purposes.

Figure 3 - Mounting Position

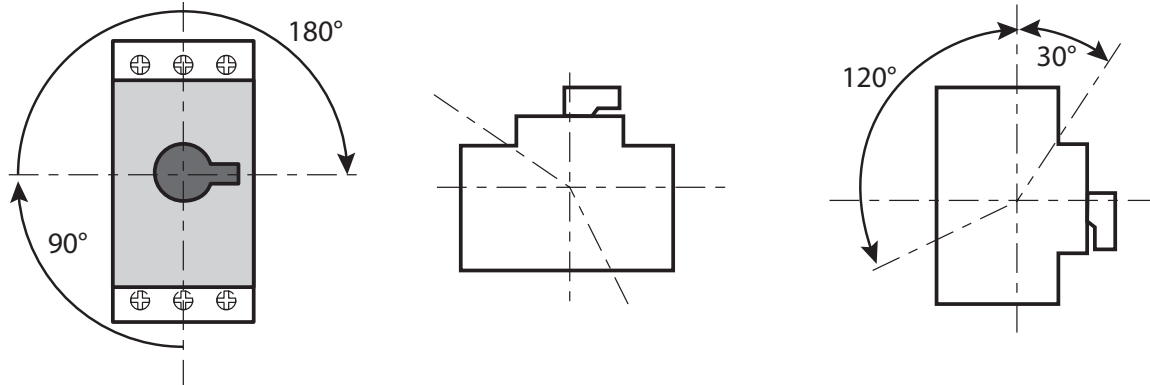

Figure 4 - Cat. No. 140MP-A3E..., 140MP-A-N45 ≤16 A

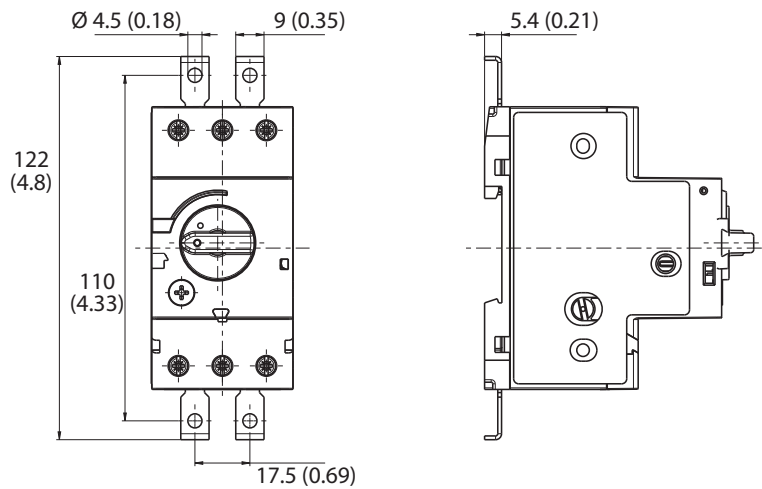

Figure 5 - Cat. No. 140MP-A3E..., 140MP-A-N45 ≥20 A

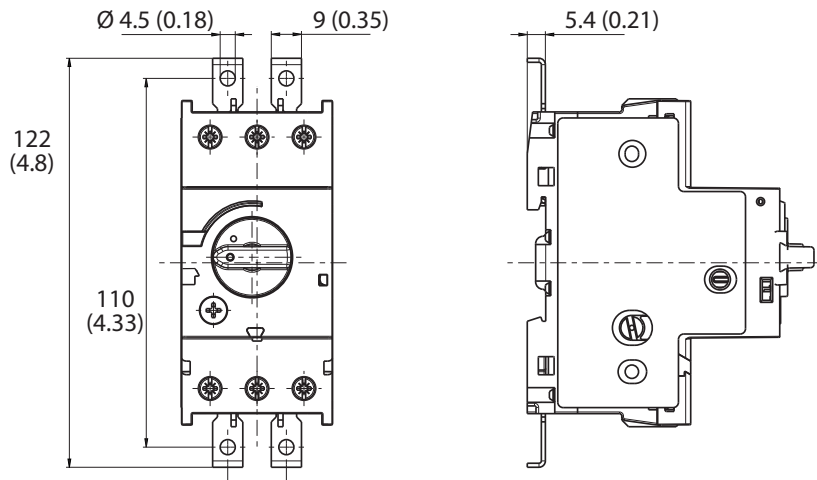

Figure 6 - Cat. No. 140MP-A3E-C16 with Accessories

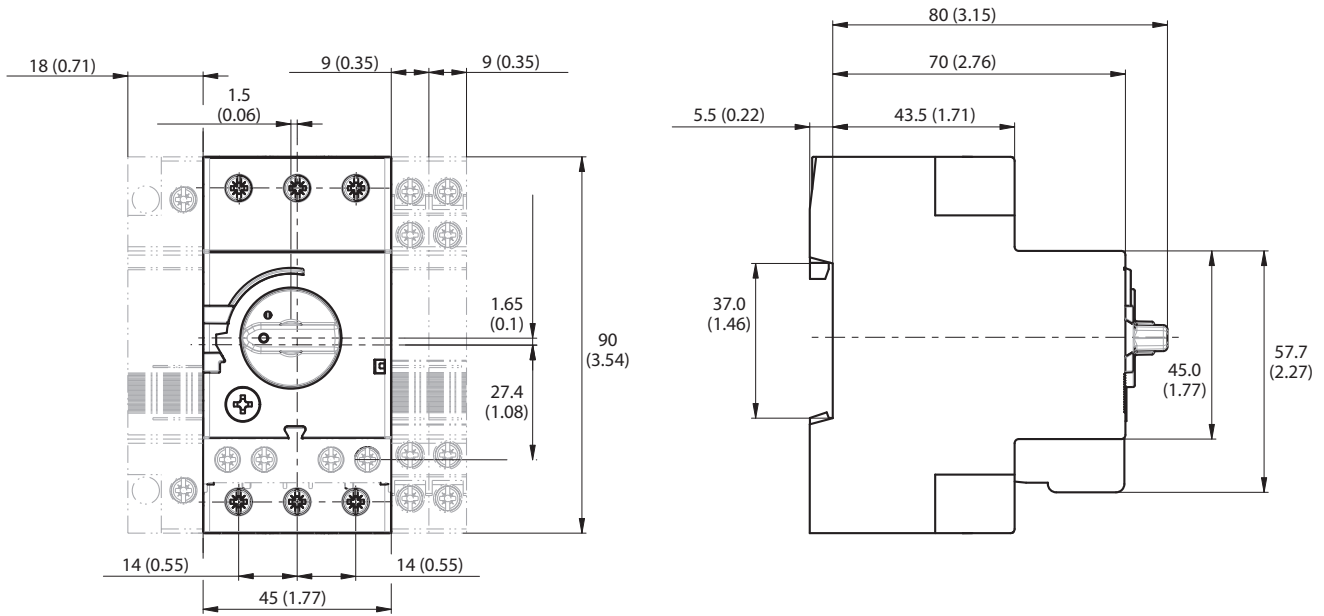
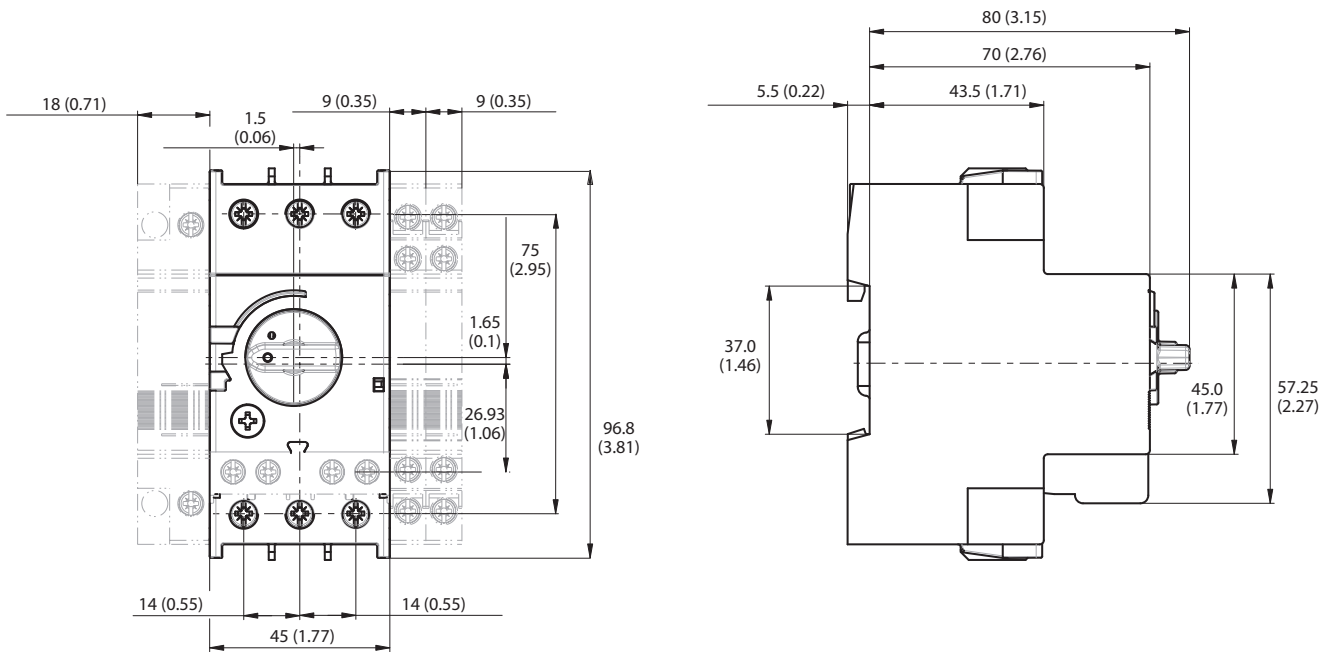

Figure 7 - Cat. No. 140MP-A3E-C32 with Accessories



## Product Overview

Bulletin 140MT Motor Protection Circuit Breakers (MPCBs) or Motor Protective Switching Devices (MPSDs) are UL Listed as Manual, Self-Protected Combination Motor Controllers (Type E) and Manual Motor Controllers (with approvals for Suitable as Motor Disconnect and Suitable for use in Group Installation).

When UL/CSA Listed as Manual, Self-Protected Combination Motor Controllers, the 140MT Motor Protection Circuit Breakers provide all of the necessary NEC/CEC requirements for the protection and control of individual Motor Branch Circuits without additional branch circuit protective devices.

According to UL 60947-4-1, CSA C22.2 No.60947-4-1, these devices may provide the following control and protection functions.

- Disconnect for motor branch circuit
- Short-circuit Protection (magnetic protection)
- Overload protection (thermal protection)
- Manual switching (motor control means)

Group motor installations eliminate the need for individual branch short-circuit protective devices for each motor circuit, reducing panel space, installation and wiring time, and costs. There is only one Branch Circuit Protective Device (BCPD) for the "Group". Bulletin 140MT devices are also UL Listed for Tap Conductor protection in group installations, which helps reduce conductor sizing.

According to UL 60947-4-1, CSA C22.2 No.60947-4-1, these devices these devices certified for group motor installation may provide the following control and protection functions.

- Disconnect for motor branch circuit
- Overload protection (thermal protection)
- Manual switching (motor control means)

Bulletin 140MT devices meet requirement of Motor Protective Switching Devices (MPSD) according to IEC 60947-4-1 and Circuit Breaker according to IEC 60947-2 standard for application outside of North America. These devices provide the following functions.

- Disconnect for motor branch circuit
- Short-circuit Protection (magnetic protection)
- Overload protection (thermal protection)
- Manual switching (motor control means)

Bulletin 140MT devices provide Trip Class 10 overload protection and phase loss sensitivity protection. These are suitable for single- and three- phase applications.

Cat. No. 140MT-D9V devices can also be applied at the output of a variable frequency drive (VFD) in multi-motor applications.



# Application Diagrams

## Group Installation with MPCBs

There is only one Branch Circuit Protective Device (BCPD) for the "Group".

Group installation has been successfully used for many years in the U.S. and Canada. It allows "two or motors or one or more motors and other loads to be connected to the same branch-circuit...". The most restrictive part of the conditions specified for Group Installation is the requirement for the protection of the conductors for each motor circuit. In the U.S. NEC for 2002, a new rule for the conductor sizing was added for devices that are listed and marked "Suitable for use as Tap Conductor Protection".

Figure 8 shows an example that illustrates installations involving multiple motors with a single BCPD protecting the entire "Group".

Bulletin 140MT Motor Protection Circuit Breakers UL/CSA Listed for Group Installation: conductors from the BCPD to each motor must be a minimum of 1/3 the ampacity of the Branch Circuit conductors.

Bulletin 140MT Motor Protection Circuit Breakers UL/CSA Listed for Tap conductor Protection in Group Installations: conductors from the BCPD to manual motor controller listed as "...Tap Conductor Protection..." must be minimum of 1/10 the rating or setting of the BCPD. Conductors from the controller to the motor must be 125% of the motor FLA.

**Figure 8 - Group Installation with MPCBs**

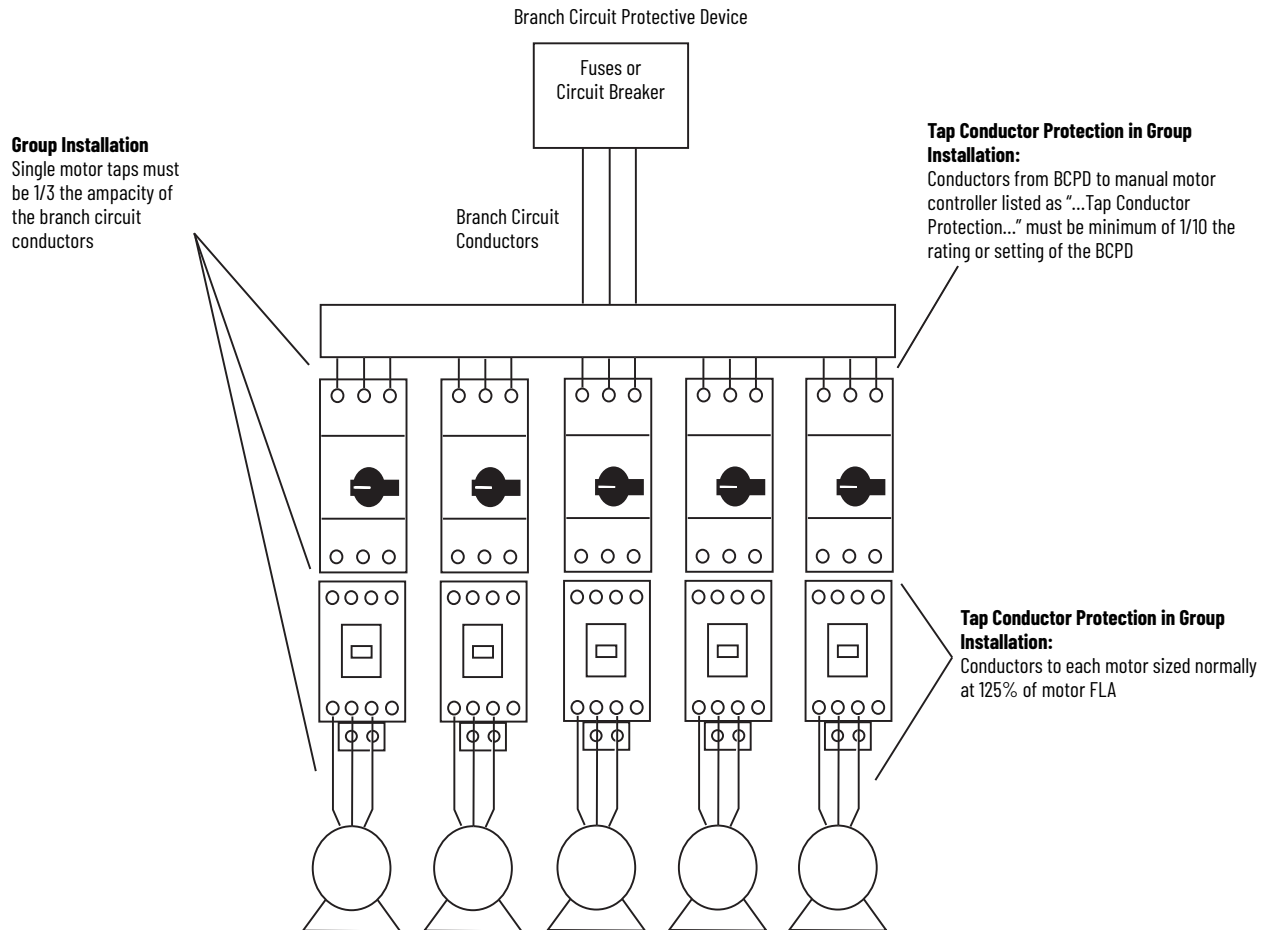

## Multiple Motor Installation with MPCBs

Each Motor has an Individual Branch Circuit Protective Device.

Bulletin 140MT Motor Protection Circuit Breakers (MPCBs) are UL/CSA Listed as Type E Manual Self-Protected Combination Motor Controllers or UL/CSA Listed as Circuit Breakers. These UL/CSA Listings allow the Bulletin 140MT MPCBs to provide the branch-circuit, short-circuit protection (as well as overload protection) for each individual motor circuit. Additional short-circuit protection is not required for the protection of the individual motor circuits, leaving only the requirement for protection of the feeder circuit conductors by an upstream protective device. [Figure 9](#) shows an example that illustrates installations involving multiple motors, each with its own branch-circuit protection (BCPD).

**Figure 9 - Multiple Motor Installation with MPCBs**

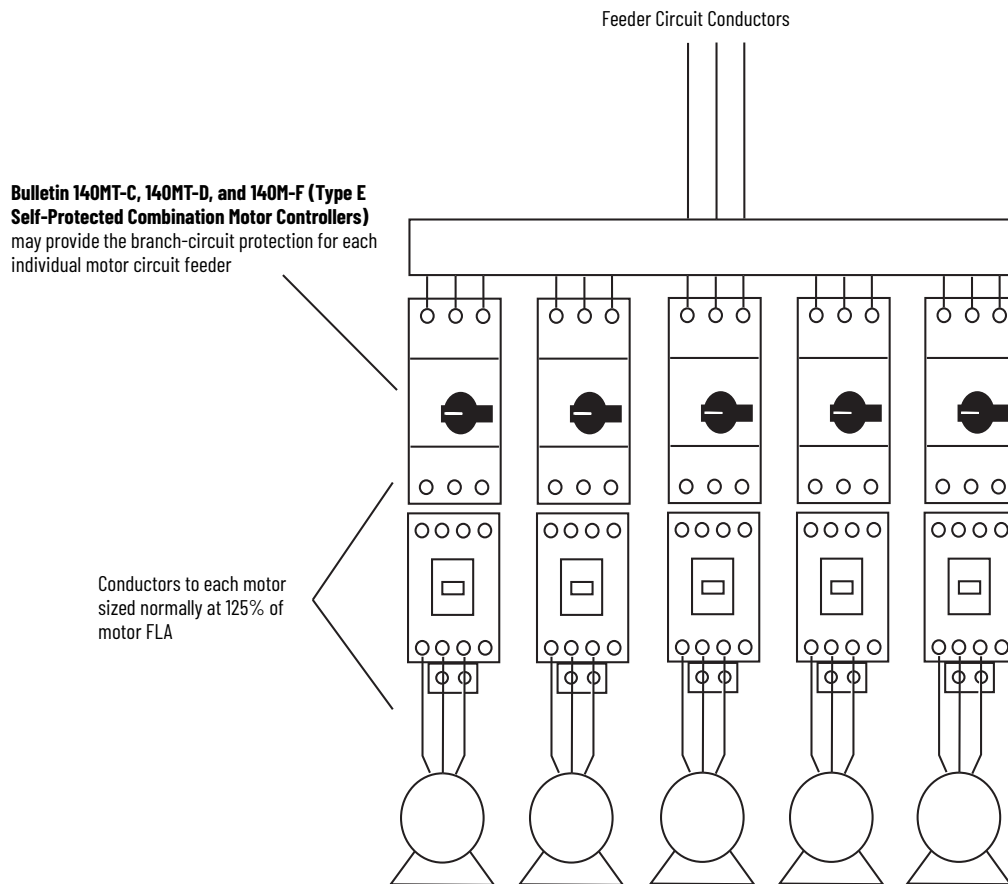

# Catalog Number Explanation

## C- and D-Frame Devices

140MT
- C
3
E
- B63
- KN
- MT
- XC
- GK

a
b
c
d
e
f
g
h
i

a	
Bulletin Number	
Code	Description
140MT	140MT Motor Protective Switching Device (Thermal)

b	
Current Rating/ Frame Size	
Code	Description
C	32 A, Frame C
D	40 A, Frame D

c	
Interrupting Rating/ Breaking Capacity	
Code	Description
3	Normal break
9	High break

d	
Function	
Code	Description
E	Adjustable Thermal/Fixed Magnetic (14 x I <sub>n</sub> ) MPCB
N	Fixed Magnetic (14 x I <sub>n</sub> ) MCP
T	Adjustable Thermal/Fixed Magnetic (18...22 x I <sub>n</sub> ) MPCB
V	Fixed Magnetic (application at output of VFD multi-motor)

e	
Current Range	
Code	Description
A	0.10 (example: A16 = 0.16 A)
B	1.0 (example: B16 = 1.6 A)
C	10 (example: C16 = 16 A)

f	
Knob and Adapters	
Code	Description
KN	Black lockable knob
KY	Red/yellow lockable knob
KB	Blue lockable knob (C-Frame only)
TE	Normal break

g	
Mounting Type	
Code	Description
MT	Standard busbar mount, top

h	
Auxiliary Contacts <sup>(1)</sup>	
Bottom Front	
1st Code	Description
X	No contact
B	1 N.O.
C	1 N.O. + 1 N.C.
D	2 N.O.
R	1 N.C. + 1 N.O. (SC+OL)
S	1 N.O. + 1 N.O. (SC+OL)
M	1 N.O. + 1 N.C. (SC+OL)
N	1 N.O. (SC+OL) + 1 N.O. (SC)
Right Side	
2nd Code	Description
X	No contact
C	1 N.O. + 1 N.C.
D	2 N.C.
E	2 N.C.

i	
Undervoltage and Shunt Trips	
Code	Description
Undervoltage Trip Units	
GK	24V, 50 Hz
GD	110V, 50 Hz/120V, 60 Hz
GF	220...230V, 50 Hz
GA	240...260V, 60 Hz
GN	380...400V, 50 Hz
GB	480V, 60 Hz/415V, 50 Hz
Shunt Trip Units	
PK	24V, 50 Hz
PD	110V, 50 Hz / 120V 60 Hz
PF	220...230V, 50 Hz
PA	240...260V, 60 Hz
PT	240V, 50 Hz/277V, 60 Hz
PN	380...400V, 50 Hz
PB	480V, 60 Hz/415V, 50 Hz
PZJ	24V DC

(1) Choose up to two auxiliary contacts. Use the first character in the code to specify the front mounted auxiliary contact; use the second character to specify the right side-mounted auxiliary contact. Example: code -XC is for no front-mounted contact, and a side-mounted auxiliary contact with 1 N.O. and 1 N.C. contact.

## F-Frame Devices

140M
- F
8
E
- C10

a
b
c
d
e

a	
Bulletin Number	
Code	Description
140M	140M Motor Protection Circuit Breaker

b	
Current Rating/ Frame Size	
Code	Description
F	45 A, Frame F

c	
Interrupting Rating/ Breaking Capacity	
Code	Description
8	High break

d	
Function	
Code	Description
E	Adjustable Thermal/Fixed Magnetic (14 x I <sub>n</sub> ) MPCB
N	Fixed Magnetic (14 x I <sub>n</sub> ) MCP
T	Adjustable Thermal/Fixed Magnetic (18...22 x I <sub>n</sub> ) MPCB

e	
Current Range	
Code	Description
C	10 (example: C16 = 16 A)



# Product Selection

## Selection Using Current and Hp/kW Ratings

Table 27 - Motor Protective Switching Devices

Rated Operational Current ( $I_e$ ) [A]	Motor Current Adjustment Range [A]	Nominal Magnetic Trip Current [A]	Max Short-circuit Current [kA]		Max. 3-phase Hp Ratings <sup>(1)</sup>				Max. kW, 3-Phase – AC-3 <sup>(1)</sup>				Cat. No.
			400V ( $I_{cu}$ )	480V (group motor)	200V	230V	460V	575V	230V	400/415V	500V	690V	
<b>C-Frame, Adjustable Thermal/Fixed Magnetic (14 x <math>I_n</math>)</b>													
0.16	0.10...0.16	2.2	100	65	–	–	–	–	–	0.02	0.06	0.06	140MT-C3E-A16
0.25	0.16...0.25	3.5	100	65	–	–	–	–	–	0.04	0.09	0.09	140MT-C3E-A25
0.4	0.25...0.40	5.6	100	65	–	–	–	–	0.06	0.09	0.12	0.18	140MT-C3E-A40
0.63	0.40...0.63	8.8	100	65	–	–	–	–	0.09	0.18	0.18	0.25	140MT-C3E-A63
1	0.63...1.0	14	100	65	–	–	0.5	0.5	0.18	0.25	0.37	0.55	140MT-C3E-B10
1.6	1.0...1.6	22	100	65	–	–	0.75	–	0.25	0.55	0.75	1.1	140MT-C3E-B16
2.5	1.6...2.5	35	100	65	0.5	0.5	1	1.5	0.37	0.75	1.1	1.8	140MT-C3E-B25
4	2.5...4.0	56	100	65	0.75	0.75	2	3	0.75	1.5	2.2	3	140MT-C3E-B40
6.3	4.0...6.3	88	100	65	1	1.5	3	5	1.5	2.2	3	4	140MT-C3E-B63
10	6.3...10	140	100	65	2	2	5	7.5	2.2	4	6.3	7.5	140MT-C3E-C10
16	10...16	224	65	30	3	5	10	10	4	7.5	10	13	140MT-C3E-C16
20	14.5...20	280	50	30	5	5	10	15	5.5	10	11	17	140MT-C3E-C20
25	18...25	350	15	30	5	7.5	15	20	5.5	11	15	22	140MT-C3E-C25
29	23...29	406	15	30	7.5	10	20	25	7.5	13	18.5	25	140MT-C3E-C29
32	26.5...32	448	15	30	7.5	10	20	30	7.5	15	20	25	140MT-C3E-C32
<b>D-Frame, Adjustable Thermal/Fixed Magnetic (14 x <math>I_n</math>)</b>													
0.63	0.40...0.63	8.8	100	65	–	–	–	–	0.09	0.18	0.18	0.25	140MT-D9E-A63
1	0.63...1.0	14	100	65	–	–	0.5	0.5	0.18	0.25	0.37	0.55	140MT-D9E-B10
1.6	1.0...1.6	22	100	65	–	–	0.75	–	0.25	0.55	0.75	1.1	140MT-D9E-B16
2.5	1.6...2.5	35	100	65	0.5	0.5	1	1.5	0.37	0.75	1.1	1.8	140MT-D9E-B25
4	2.5...4.0	56	100	65	0.75	0.75	2	3	0.75	1.5	2.2	3	140MT-D9E-B40
6.3	4.0...6.3	88	100	65	1	1.5	3	5	1.5	2.2	3	4	140MT-D9E-B63
10	6.3...10	140	100	65	2	2	5	7.5	2.2	4	6.3	7.5	140MT-D9E-C10
16	10...16	224	100	65	3	5	10	10	4	7.5	10	13	140MT-D9E-C16
20	14.5...20	280	100	65	5	5	10	15	5.5	10	11	17	140MT-D9E-C20
25	18...25	350	65	50	5	7.5	15	20	5.5	11	15	22	140MT-D9E-C25
29	23...29	406	50	50	7.5	10	20	25	7.5	13	18.5	25	140MT-D9E-C29
32	26.5...32	448	50	50	7.5	10	20	30	7.5	15	20	25	140MT-D9E-C32
36	30...36	432	50	30	10	10	25	30	–	18.5	20	25	140MT-D9E-C36 <sup>(2)</sup>
40	34...40	480	50	30	10	10	30	30	11	20	24	30	140MT-D9E-C40 <sup>(2)</sup>
<b>D-Frame, Fixed Magnetic (application at output of VFD multi-motor)</b>													
1.6	1.0...1.6	88	100	65	–	–	0.75	–	0.25	0.55	0.75	–	140MT-D9V-B16
2.5	1.6...2.5	88	100	65	0.5	0.5	1	–	0.37	0.75	1.1	–	140MT-D9V-B25
4	2.5...4.0	88	100	65	0.75	0.75	2	–	0.75	1.5	2.2	–	140MT-D9V-B40
6.3	4.0...6.3	88	100	65	1	1.5	3	–	1.5	2.2	3	–	140MT-D9V-B63
10	6.3...10	140	100	65	2	2	5	–	2.2	4	6.3	–	140MT-D9V-C10
16	10...16	224	100	65	3	5	10	–	4	7.5	10	–	140MT-D9V-C16
20	14.5...20	280	100	65	5	5	10	–	5.5	10	11	–	140MT-D9V-C20
25	18...25	350	65	50	5	7.5	15	–	5.5	11	15	–	140MT-D9V-C25
29	23...29	406	50	50	7.5	10	20	–	7.5	13	18.5	–	140MT-D9V-C29
32	26.5...32	448	50	50	7.5	10	20	–	7.5	15	20	–	140MT-D9V-C32
36	30...36	432	50	30	10	10	25	–	–	18.5	20	–	140MT-D9V-C36 <sup>(2)</sup>
40	34...40	480	50	30	10	10	30	–	11	20	24	–	140MT-D9V-C40 <sup>(2)</sup>

**Table 27 - Motor Protective Switching Devices (Continued)**

Rated Operational Current ( $I_e$ ) [A]	Motor Current Adjustment Range [A]	Nominal Magnetic Trip Current [A]	Max Short-circuit Current [kA]		Max. 3-phase Hp Ratings <sup>(1)</sup>				Max. kW, 3-Phase – AC-3 <sup>(1)</sup>				Cat. No.
			400V ( $I_{cu}$ )	480V (group motor)	200V	230V	460V	575V	230V	400/415V	500V	690V	
<b>F-Frame, Adjustable Thermal/Fixed Magnetic (13 x <math>I_n</math>)</b>													
10	6.3...10	130	100	65	2	3	5	7.5	2.2	4	6.3	7.5	140M-F8E-C10
16	10...16	208	100	65	3	5	10	10	4	7.5	10	13	140M-F8E-C16
20	14.5...20	260	100	65	5	5	10	15	5.5	10	11	17	140M-F8E-C20
25	18...25	325	100	65	7.5	7.5	15	20	5.5	11	15	22	140M-F8E-C25
32	23...32	416	65	65	7.5	10	20	30	7.5	15	20	25	140M-F8E-C32
45	32...45	585	65	65	10	15	30	40	13	22	30	40	140M-F8E-C45
25	18...25	416	65	65	7.5	7.5	15	20	5.5	11	15	22	140M-F8T-C25
32	23...32	585	65	65	7.5	10	20	30	7.5	15	20	25	140M-F8T-C32

(1) Horsepower/kW ratings shown are for reference. The final selection of the MPCB/MPSD depends on the actual motor full load current.

(2) Suitable for continuous operation at 90% current rating at 480V only if used in a minimum enclosure size of 250 x 175 x 150 mm (10 x 7 x 6 in).

**Table 28 - High Inrush Motor Protection Switching Devices**

Rated Operational Current ( $I_e$ ) [A]	Motor Current Adjustment Range [A]	Nominal Magnetic Trip Current [A]	Max Short-circuit Current [kA]		Max. 3-phase Hp Ratings <sup>(1)</sup>				Max. kW, 3-Phase – AC-3 <sup>(1)</sup>				Cat. No.
			400V	480V	200V	230V	460V	575V	230V	400/415V	500V	690V	
			( $I_{cu}$ )	(group motor)									
<b>D-Frame, Adjustable Thermal/Fixed Magnetic (18...22 x <math>I_n</math>)</b>													
0.16	0.10...0.16	3.5	100	65	–	–	–	–	–	0.02	0.06	0.06	140MT-D9T-A16
0.25	0.16...0.25	5.5	100	65	–	–	–	–	–	0.04	0.09	0.09	140MT-D9T-A25
0.4	0.25...0.40	8.8	100	65	–	–	–	–	0.06	0.09	0.12	0.18	140MT-D9T-A40
0.63	0.40...0.63	14	100	65	–	–	–	–	0.09	0.18	0.18	0.25	140MT-D9T-A63
1	0.63...1.0	22	100	65	–	–	0.5	0.5	0.18	0.25	0.37	0.55	140MT-D9T-B10
1.6	1.0...1.6	35	100	65	–	–	0.75	–	0.25	0.55	0.75	1.1	140MT-D9T-B16
2.5	1.6...2.5	55	100	65	0.5	0.5	1	1.5	0.37	0.75	1.1	1.8	140MT-D9T-B25
4	2.5...4.0	88	100	65	0.75	0.75	2	3	0.75	1.5	2.2	3	140MT-D9T-B40
6.3	4.0...6.3	139	100	65	1	1.5	3	5	1.5	2.2	3	4	140MT-D9T-B63
10	6.3...10	220	100	65	2	2	5	7.5	2.2	4	6.3	7.5	140MT-D9T-C10
16	10...16	320	100	65	3	5	10	10	4	7.5	10	13	140MT-D9T-C16
20	14.5...20	400	100	65	5	5	10	15	5.5	10	11	17	140MT-D9T-C20
25	18...25	450	65	50	5	7.5	15	20	5.5	11	15	22	140MT-D9T-C25
<b>F-Frame, Adjustable Thermal/Fixed Magnetic (16...22 x <math>I_n</math>)</b>													
25	18...25	416	65	65	7.5	7.5	15	20	5.5	11	15	22	140M-F8T-C25
32	23...32	585	65	65	7.5	10	20	30	7.5	15	20	25	140M-F8T-C32

(1) Horsepower/kW ratings shown are for reference. The final selection of the MPCB/MPSD depends on the actual motor full load current.

Table 29 - Motor Circuit Protectors

Rated Operational Current ( $I_e$ ) [A]	Motor Current Adjustment Range [A]	Nominal Magnetic Trip Current [A]	Max. Short Circuit Current [kA]		Max. 3-phase Hp Ratings <sup>(1)</sup>				Max. kW, 3-Phase – AC-3 <sup>(1)</sup>				Cat. No.
			400V	480V	200V	230V	460V	575V	230V	400/415V	500V	690V	
			( $I_{cu}$ )	(group motor)									
<b>D-Frame, Fixed Magnetic (14 x <math>I_n</math>)</b>													
0.16	–	2.2	100	65	–	–	–	–	–	0.02	0.06	0.06	140MT-D9N-A16
0.25	–	3.5	100	65	–	–	–	–	–	0.04	0.09	0.09	140MT-D9N-A25
0.4	–	5.6	100	65	–	–	–	–	0.06	0.09	0.12	0.18	140MT-D9N-A40
0.63	–	8.8	100	65	–	–	–	–	0.09	0.18	0.18	0.25	140MT-D9N-A63
1	–	14	100	65	–	–	0.5	0.5	0.18	0.25	0.37	0.55	140MT-D9N-B10
1.6	–	22	100	65	–	–	0.75	–	0.25	0.55	0.75	1.1	140MT-D9N-B16
2.5	–	35	100	65	0.5	0.5	1	1.5	0.37	0.75	1.1	1.8	140MT-D9N-B25
4	–	56	100	65	0.75	0.75	2	3	0.75	1.5	2.2	3	140MT-D9N-B40
6.3	–	88	100	65	1	1.5	3	5	1.5	2.2	3	4	140MT-D9N-B63
10	–	140	100	65	2	2	5	7.5	2.2	4	6.3	7.5	140MT-D9N-C10
16	–	224	100	65	3	5	10	10	4	7.5	10	13	140MT-D9N-C16
20	–	280	100	65	5	5	10	15	5.5	10	11	17	140MT-D9N-C20
25	–	350	65	50	5	7.5	15	20	5.5	11	15	22	140MT-D9N-C25
29	–	406	50	50	7.5	10	20	25	7.5	13	18.5	25	140MT-D9N-C29
32	–	448	50	50	7.5	10	20	30	7.5	15	20	25	140MT-D9N-C32
36	–	432	50	30	10	10	25	30	–	18.5	20	25	140MT-D9N-C36 <sup>(2)</sup>
40	–	480	50	30	10	10	30	30	11	20	24	30	140MT-D9N-C40 <sup>(2)</sup>
<b>F-Frame, Fixed Magnetic (13 x <math>I_n</math>)</b>													
25	–	325	100	65	7.5	10	20	25	6.3	11	15	22	140M-F8N-C25
32	–	416	65	65	7.5	10	25	30	7.5	15	20	30	140M-F8N-C32
45	–	585	65	65	10	15	30	40	13	22	30	40	140M-F8N-C45

(1) Horsepower/kW ratings shown are for reference. The final selection of the MCP depends on the actual motor full load current.  
 (2) Suitable for continuous operation at 90% current rating at 480V only if used in a minimum enclosure size of 250 x 175 x 150 mm (10 x 7 x 6 in).



Motor Circuit Protectors (Cat. No. 140MT-D9N, 140M-F8N) do not provide thermal protection for themselves nor for downstream components. You must install a separate protective device against thermal overload, such as an overload relay as part of a starter combination. In applications that use these devices as the short-circuit protection device of heavy-duty starting motors, the rated operational current  $I_e$  of the devices must be over-sized using the factors in [Table 30](#).

Table 30 - Oversizing for Heavy-duty Starting

Current Range [A]	Device Type	Class 10	Class 20	Class 30
0.16...10	140MT-D9N	–	–	–
16...29		–	–	1.41
32...40		–	1.41	1.73
25...45	140M-F8N	–	1.41	1.73

# Selection Using Application Ratings

See [page 42](#) for combination ratings.

**Table 31 - UL/CSA Listed Application Ratings, Motor Protective Switching Devices**

Max. Fuse or Circuit Breaker per NEC [A]	UL 60947-4-1 – Manual Motor Controller						UL 60947-4-1 Self-Protected (Type E) Combination Motor Controller		Cat. No.
	Max Short-circuit Current [kA]						Max Short-circuit Current [kA]		
	Group Motor Installation		Motor Disconnect		Tap Conductor Protection		480Y/277V <sup>(1)</sup>	600Y/347V <sup>(1)</sup>	
480V	600V	480V	600V	480Y/277V <sup>(1)</sup>	600Y/347V <sup>(1)</sup>				
<b>C-Frame, Adjustable Thermal/Fixed Magnetic (14 x I<sub>n</sub>)</b>									
450	65	50	65	50	65	50	65	50	140MT-C3E-A16
450	65	50	65	50	65	50	65	50	140MT-C3E-A25
450	65	50	65	50	65	50	65	50	140MT-C3E-A40
450	65	50	65	50	65	50	65	50	140MT-C3E-A63
450	65	50	65	50	65	50	65	50	140MT-C3E-B10
450	65	50	65	50	65	50	65	50	140MT-C3E-B16
450	65	30	65	30	65	30	65	30	140MT-C3E-B25
450	65	30	65	30	65	30	65	30	140MT-C3E-B40
450	65	30	65	30	65	–	65	–	140MT-C3E-B63
450	65	30	65	30	65	–	65	–	140MT-C3E-C10
450	30	30	30	30	30	–	30	–	140MT-C3E-C16
450	30	30	30	10	–	–	–	–	140MT-C3E-C20
450	30	18	30	5	–	–	–	–	140MT-C3E-C25
450	30	10	10	–	–	–	–	–	140MT-C3E-C29
450	30	10	10	–	–	–	–	–	140MT-C3E-C32
<b>D-Frame, Adjustable Thermal/Fixed Magnetic (14 x I<sub>n</sub>)</b>									
450	65	50	65	50	65	50	65	50	140MT-D9E-A63
450	65	50	65	50	65	50	65	50	140MT-D9E-B10
450	65	50	65	50	65	50	65	50	140MT-D9E-B16
450	65	30	65	30	65	30	65	30	140MT-D9E-B25
450	65	30	65	30	65	30	65	30	140MT-D9E-B40
450	65	30	65	30	65	30	65	30	140MT-D9E-B63
450	65	30	65	30	65	30	65	30	140MT-D9E-C10
450	65	30	65	30	65	30	65	30	140MT-D9E-C16
450	65	30	65	30	65	–	65	–	140MT-D9E-C20
450	50	30	50	30	50	–	50	–	140MT-D9E-C25
450	50	30	50	30	50	–	50	–	140MT-D9E-C29
450	50	30	30	18	30	–	30	–	140MT-D9E-C32
450	30	30	30	18	30	–	30	–	140MT-D9E-C36 <sup>(2)</sup>
450	30	30	30	18	30	–	30	–	140MT-D9E-C40 <sup>(2)</sup>
<b>D-Frame, Adjustable Thermal/Fixed Magnetic (application at output of VFD multi-motor)</b>									
450	65	–	65	–	65	–	65	–	140MT-D9V-B16
450	65	–	65	–	65	–	65	–	140MT-D9V-B25
450	65	–	65	–	65	–	65	–	140MT-D9V-B40
450	65	–	65	–	65	–	65	–	140MT-D9V-B63
450	65	–	65	–	65	–	65	–	140MT-D9V-C10
450	65	–	65	–	65	–	65	–	140MT-D9V-C16
450	65	–	65	–	65	–	65	–	140MT-D9V-C20
450	50	–	50	–	50	–	50	–	140MT-D9V-C25
450	50	–	50	–	50	–	50	–	140MT-D9V-C29
450	50	–	30	–	30	–	30	–	140MT-D9V-C32
450	30	–	30	–	30	–	30	–	140MT-D9V-C36 <sup>(2)</sup>

Table 31 - UL/CSA Listed Application Ratings, Motor Protective Switching Devices (Continued)

Max. Fuse or Circuit Breaker per NEC [A]	UL 60947-4-1 – Manual Motor Controller						UL 60947-4-1 Self-Protected (Type E) Combination Motor Controller		Cat. No.
	Max Short-circuit Current [kA]						Max Short-circuit Current [kA]		
	Group Motor Installation		Motor Disconnect		Tap Conductor Protection				
480V	600V	480V	600V	480Y/277V <sup>(1)</sup>	600Y/347V <sup>(1)</sup>	480Y/277V <sup>(1)</sup>	600Y/347V <sup>(1)</sup>		
450	30	–	30	–	30	–	30	–	140MT-D9V-C40 <sup>(2)</sup>
<b>D-Frame, Adjustable Thermal/Fixed Magnetic (18...22 x I<sub>n</sub>)</b>									
450	65	50	65	50	65	50	65	50	140MT-D9T-A16
450	65	50	65	50	65	50	65	50	140MT-D9T-A25
450	65	50	65	50	65	50	65	50	140MT-D9T-A40
450	65	50	65	50	65	50	65	50	140MT-D9T-A63
450	65	50	65	50	65	50	65	50	140MT-D9T-B10
450	65	50	65	50	65	50	65	50	140MT-D9T-B16
450	65	30	65	30	65	30	65	30	140MT-D9T-B25
450	65	30	65	30	65	30	65	30	140MT-D9T-B40
450	65	30	65	30	65	30	65	30	140MT-D9T-B63
450	65	30	65	30	65	30	65	30	140MT-D9T-C10
450	65	30	65	30	65	30	65	–	140MT-D9T-C16
450	65	30	65	30	65	–	65	–	140MT-D9T-C20
450	50	30	50	18	50	–	50	–	140MT-D9T-C25
<b>F-Frame, Adjustable Thermal/Fixed Magnetic (13 x I<sub>n</sub>)</b>									
600	65	30	65	30	65	30	65	30	140M-F8E-C10
600	65	30	65	30	65	30	65	30	140M-F8E-C16
600	65	30	65	30	65	30	65	30	140M-F8E-C20
600	65	30	65	30	65	30	65	30	140M-F8E-C25
600	65	30	65	30	65	30	65	30	140M-F8E-C32
600	65	18	65	18	65	–	65	–	140M-F8E-C45
<b>F-Frame, Adjustable Thermal/Fixed Magnetic (16...22 x I<sub>n</sub>)</b>									
600	65	30	65	30	65	30	65	30	140M-F8T-C25
600	65	18	65	18	65	18	65	18	140M-F8T-C32

(1) For full voltage (delta) ratings above 277V or 347V, follow the NEC or CEC rules for group motor applications.

(2) Suitable for continuous operation at 90% current rating at 480V only if used in a minimum enclosure size of 250 x 175 x 150 mm (10 x 7 x 6 in).

Table 32 - UL/CSA Listed Application Ratings, Motor Circuit Protectors

UL 60947-4-1 – Manual Motor Controller							Cat. No.
Max. Fuse or Circuit Breaker per NEC [A]	Max. Short Circuit Current [kA]						
	Group Motor Installation		Motor Disconnect		Tap Conductor Protection		
	480V	600V	480V	600V	480Y/277V <sup>(1)</sup>	600Y/347V <sup>(1)</sup>	
<b>D-Frame, Fixed Magnetic (14 x I<sub>n</sub>)</b>							
450	65	50	65	50	65	50	140MT-D9N-A16
450	65	50	65	50	65	50	140MT-D9N-A25
450	65	50	65	50	65	50	140MT-D9N-A40
450	65	50	65	50	65	50	140MT-D9N-A63
450	65	50	65	50	65	50	140MT-D9N-B10
450	65	50	65	50	65	50	140MT-D9N-B16
450	65	30	65	30	65	30	140MT-D9N-B25
450	65	30	65	30	65	30	140MT-D9N-B40
450	65	30	65	30	65	30	140MT-D9N-B63
450	65	30	65	30	65	30	140MT-D9N-C10
450	65	30	65	30	65	30	140MT-D9N-C16
450	65	30	65	30	65	–	140MT-D9N-C20
450	50	30	50	30	50	–	140MT-D9N-C25
450	50	30	50	30	50	–	140MT-D9N-C29
450	50	30	30	18	30	–	140MT-D9N-C32
450	30	30	30	18	30	–	140MT-D9N-C36 <sup>(2)</sup>
450	30	30	30	18	30	–	140MT-D9N-C40 <sup>(2)</sup>
<b>F-Frame, Fixed Magnetic (13 x I<sub>n</sub>)</b>							
600	65	30	65	30	–	–	140M-F8N-C25
600	65	30	65	30	–	–	140M-F8N-C32
600	65	18	65	18	–	–	140M-F8N-C45

(1) For full voltage (delta) ratings above 277V or 347V, follow the NEC or CEC rules for group motor applications.  
 (2) Suitable for continuous operation at 90% current rating at 480V only if used in a minimum enclosure size of 250 x 175 x 150 mm (10 x 7 x 6 in).

Table 33 - IEC Application Ratings, Interrupting Rating/Breaking Capacity

Breaking Capacity, IEC 60947-2															Cat. No.
230/240V AC			400/415V AC			440/460V AC			500/525V AC			690V AC			
I <sub>cu</sub> [kA]	I <sub>cs</sub> [kA]	Back-up Fuse Rating <sup>(1)</sup> [A]	I <sub>cu</sub> [kA]	I <sub>cs</sub> [kA]	Back-up Fuse Rating <sup>(1)</sup> [A]	I <sub>cu</sub> [kA]	I <sub>cs</sub> [kA]	Back-up Fuse Rating <sup>(1)</sup> [A]	I <sub>cu</sub> [kA]	I <sub>cs</sub> [kA]	Back-up Fuse Rating <sup>(1)</sup> [A]	I <sub>cu</sub> [kA]	I <sub>cs</sub> [kA]	Back-up Fuse Rating <sup>(1)</sup> [A]	
<b>C-Frame, Adjustable Thermal/Fixed Magnetic (14 x I<sub>n</sub>)</b>															
100	100	_(2)	100	100	_(2)	100	100	_(2)	100	100	_(2)	100	100	_(2)	140MT-C3E-A16
100	100		100	100		100	100		100	100					
100	100		100	100		100	100		100	100					
100	100		100	100		100	100		100	100					
100	100		100	100		100	100		100	100					
100	100		100	100		100	100		100	100					
100	100		100	100		100	100		100	100					
100	100		100	100		100	100		100	100					
100	100		100	100		100	100		100	100					
100	100		100	100		100	100		100	100					
100	100		100	100		100	100		100	100					
100	100		100	100		100	100		100	100					
100	100		100	100		100	100		100	100					
100	100		100	100		100	100		100	100					
100	100	100	100	100	100	100	100								
65	50	100	50	15	100	6	6	80	6	6	80	3	2	63	140MT-C3E-C20
65	50	100	15	15	100	6	4	80	6	4	80	3	2	63	140MT-C3E-C25
50	25	125	15	10	125	6	4	100	6	4	100	3	2	80	140MT-C3E-C29
50	25	125	15	10	125	6	4	100	6	4	100	3	2	80	140MT-C3E-C32

Table 33 - IEC Application Ratings, Interrupting Rating/Breaking Capacity (Continued)

Breaking Capacity, IEC 60947-2															Cat. No.					
230/240V AC			400/415V AC			440/460V AC			500/525V AC			690V AC								
$I_{cu}$ [kA]	$I_{cs}$ [kA]	Back-up Fuse Rating <sup>(1)</sup> [A]	$I_{cu}$ [kA]	$I_{cs}$ [kA]	Back-up Fuse Rating <sup>(1)</sup> [A]	$I_{cu}$ [kA]	$I_{cs}$ [kA]	Back-up Fuse Rating <sup>(1)</sup> [A]	$I_{cu}$ [kA]	$I_{cs}$ [kA]	Back-up Fuse Rating <sup>(1)</sup> [A]	$I_{cu}$ [kA]	$I_{cs}$ [kA]	Back-up Fuse Rating <sup>(1)</sup> [A]						
<b>D-Frame, Adjustable Thermal/Fixed Magnetic (14 x <math>I_n</math>)</b>																				
100	100	_(2)	100	100	_(2)	100	100	_(2)	100	100	_(2)	100	100	_(2)	140MT-D9E-A63					
100	100		100	100		100	100		100	100		100	100		100	100	100	100	140MT-D9E-B10	
100	100		100	100		100	100		100	100		100	100		100	100	100	100	140MT-D9E-B16	
100	100		100	100		100	100		100	100		100	100		100	100	6	4	20	140MT-D9E-B25
100	100		100	100		100	100		100	100		100	100		100	100	6	4	35	140MT-D9E-B40
100	100		100	100		100	100		100	100		100	100		100	100	6	4	50	140MT-D9E-B63
100	100		100	100		100	100		100	100		100	100		100	100	6	3	50	140MT-D9E-C10
100	100		100	50		80	50		25	80		50	25		80	4	3	63	140MT-D9E-C16	
100	100		100	25		100	50		25	100		50	25		80	4	3	63	140MT-D9E-C20	
100	100		100	65		25	100		35	20		100	35		20	80	4	3	63	140MT-D9E-C25
65	50	125	50	25	125	25	15	125	25	15	100	4	3	80	140MT-D9E-C29					
65	50	125	50	25	125	25	15	125	25	15	100	4	3	80	140MT-D9E-C32					
50	35	125	50	25	125	12	6	125	12	6	100	3	2	100	140MT-D9E-C36 <sup>(3)</sup>					
50	35	125	50	25	125	12	6	125	12	6	100	3	2	100	140MT-D9E-C40 <sup>(3)</sup>					
<b>D-Frame, Fixed Magnetic (application at output of VFD multi-motor)</b>																				
100	100	_(2)	100	100	_(2)	100	100	_(2)	100	100	_(2)	-	-	_(2)	140MT-D9V-B16					
100	100		100	100		100	100		100	100		100	100		100	-	-	140MT-D9V-B25		
100	100		100	100		100	100		100	100		100	100		100	-	-	140MT-D9V-B40		
100	100		100	100		100	100		100	100		100	100		100	-	-	140MT-D9V-B63		
100	100		100	100		100	100		100	100		100	100		100	-	-	140MT-D9V-C10		
100	100		100	50		80	50		25	80		50	25		80	-	-	140MT-D9V-C16		
100	100		100	25		100	50		25	100		50	25		80	-	-	140MT-D9V-C20		
100	100		100	65		25	100		35	20		100	35		20	80	-	-	140MT-D9V-C25	
65	50		125	50		25	125		25	15		125	25		15	100	-	-	140MT-D9V-C29	
65	50		125	50		25	125		25	15		125	25		15	100	-	-	140MT-D9V-C32	
50	35	125	50	25	125	12	6	125	12	6	100	-	-	140MT-D9V-C36 <sup>(3)</sup>						
50	35	125	50	25	125	12	6	125	12	6	100	-	-	140MT-D9V-C40 <sup>(3)</sup>						
<b>F-Frame, Adjustable Thermal/Fixed Magnetic (13 x <math>I_n</math>)</b>																				
100	100	_(2)	100	50	80	65	50	80	50	50	80	10	10	63	140M-F8E-C10					
100	100		100	50	100	65	50	100	50	50	100	10	10	80	140M-F8E-C16					
100	100		100	50	100	65	50	100	50	50	100	10	10	80	140M-F8E-C20					
100	100		100	50	100	65	50	100	50	50	100	10	10	80	140M-F8E-C25					
100	100		100	65	50	125	65	50	125	50	50	125	10	6	100	140M-F8E-C32				
100	100		100	65	50	125	50	50	125	50	50	125	10	6	100	140M-F8E-C45				

Table 33 - IEC Application Ratings, Interrupting Rating/Breaking Capacity (Continued)









Breaking Capacity, IEC 60947-2															Cat. No.
230/240V AC			400/415V AC			440/460V AC			500/525V AC			690V AC			
$I_{cu}$ [kA]	$I_{cs}$ [kA]	Back-up Fuse Rating <sup>(1)</sup> [A]	$I_{cu}$ [kA]	$I_{cs}$ [kA]	Back-up Fuse Rating <sup>(1)</sup> [A]	$I_{cu}$ [kA]	$I_{cs}$ [kA]	Back-up Fuse Rating <sup>(1)</sup> [A]	$I_{cu}$ [kA]	$I_{cs}$ [kA]	Back-up Fuse Rating <sup>(1)</sup> [A]	$I_{cu}$ [kA]	$I_{cs}$ [kA]	Back-up Fuse Rating <sup>(1)</sup> [A]	
<b>D-Frame, High Inrush, Adjustable Thermal/Fixed Magnetic (18...22 x <math>I_n</math>)</b>															
100	100	_(2)	100	100	_(2)	100	100	_(2)	100	100	_(2)	100	100	_(2)	140MT-D9T-A16
100	100		100	100		100	100		100	100		100	100		
100	100		100	100		100	100		100	100		100	100		
100	100		100	100		100	100		100	100		100	100		
100	100		100	100		100	100		100	100		100	100		
100	100		100	100		100	100		100	100		100	100		
100	100		100	100		100	100		100	100		100	100		
100	100		100	100		100	100		100	100		100	100		
100	100		100	100		100	100		100	100		100	100		
100	100		100	100		100	100		100	100		100	100		
100	100		100	100		100	100		100	100		100	100		
100	100		100	100		100	100		100	100		100	100		
100	100		100	100		100	100		100	100		100	100		
100	100		100	100		100	100		100	100		100	100		
100	100	100	100	100	100	100	100	100	100						
100	100		100	50	80	50	25	80	50	25	80	4	3	63	140MT-D9T-C16
100	100		100	25	100	50	25	100	50	25	80	4	2	63	140MT-D9T-C20
100	100		65	25	100	50	12	100	50	12	80	4	2	63	140MT-D9T-C25
<b>F-Frame, High Inrush, Adjustable Thermal/Fixed Magnetic (16...22 x <math>I_n</math>)</b>															
100	100	_(2)	65	50	100	65	50	100	50	50	100	10	6	80	140M-F8T-C25
100	100		65	50	125	65	50	125	50	50	125	10	6	100	140M-F8T-C32
<b>D-Frame, Motor Circuit Protectors, Fixed Magnetic (14 x <math>I_n</math>)</b>															
100	100	_(2)	100	100	_(2)	100	100	_(2)	100	100	_(2)	100	100	_(2)	140MT-D9N-A16
100	100		100	100		100	100		100	100		100	100		
100	100		100	100		100	100		100	100		100	100		
100	100		100	100		100	100		100	100		100	100		
100	100		100	100		100	100		100	100		100	100		
100	100		100	100		100	100		100	100		100	100		
100	100		100	100		100	100		100	100		100	100		
100	100		100	100		100	100		100	100		100	100		
100	100		100	100		100	100		100	100		100	100		
100	100		100	100		100	100		100	100		100	100		
100	100		100	100		100	100		100	100		100	100		
100	100		100	100		100	100		100	100		100	100		
100	100		100	100		100	100		100	100		100	100		
100	100		100	100		100	100		100	100		100	100		
100	100		100	50	80	50	25	80	50	25	80	4	3	63	140MT-D9N-C16
100	100		100	25	100	50	25	100	50	25	80	4	3	63	140MT-D9N-C20
100	100		65	25	100	35	20	100	35	20	80	4	3	63	140MT-D9N-C25
65	50	125	50	25	125	25	15	125	25	15	100	4	3	80	140MT-D9N-C29
65	50	125	50	25	125	25	15	125	25	15	100	4	3	80	140MT-D9N-C32
50	35	125	50	25	125	12	6	125	12	6	100	3	2	100	140MT-D9N-C36 <sup>(3)</sup>
50	35	125	50	25	125	12	6	125	12	6	100	3	2	100	140MT-D9N-C40 <sup>(3)</sup>
<b>F-Frame, Motor Circuit Protectors, Fixed Magnetic (13 x <math>I_n</math>)</b>															
100	100	100	100	50	100	65	50	100	50	50	100	10	10	80	140M-F8N-C25
100	100	125	65	50	125	65	50	125	50	50	125	10	6	100	140M-F8N-C32
100	100	125	65	50	125	50	50	125	50	50	125	10	6	100	140M-F8N-C45

(1) Back-up fuses are type gG, aM.  
 (2) No Back-up fuse required if  $I_{cc} < I_{cs}$ .  
 (3) Suitable for continuous operation at 90% current rating at 480V only if used in a minimum enclosure size of 250 x 175 x 150 mm (10 x 7 x 6 in).

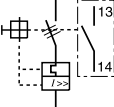
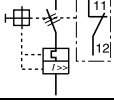
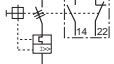
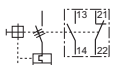
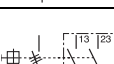

# Accessories

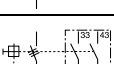
Table 34 - Auxiliary Contacts

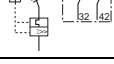
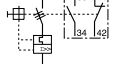
Description	Operator Position <sup>(1)</sup>			Term. No.	Contact Description	Connection Diagram <sup>(2)</sup>	For Use With	Cat. No.	
	OFF	ON	Tripped						
 Front-Mounted Auxiliary Contact <ul style="list-style-type: none"> <li>• 1-pole or 2-pole</li> <li>• No additional space required</li> <li>• Only one per device</li> </ul> 	0	X	0	13-14	N.O. Aux		140MT-C, D 140UT-D	140MT-C-AFA10	
								140M-F	140M-C-AFA10
	X	0	X	11-12	N.C. Aux		140M-F	140M-C-AFA01	
	0	X	0	13-14	N.O. Aux		140MT-C, D 140UT-D	140MT-C-AFA11	
	X	0	X	21-22	N.C. Aux		140M-F	140M-C-AFA11	
	0	X	0	13-14	N.O. Aux		140MT-C, D 140UT-D	140MT-C-AFA20	
	X	0	X	21-22	N.C. Aux		140M-F	140M-C-AFA20	
	0	X	0	23-24	N.O. Aux		140MT-C, D 140UT-D	140MT-C-ASA20	
	0	X	0	13-14	N.O. Aux		140M-F	140M-C-AFA02	
	X	0	X	11-12	N.C. Aux		140MT-C, D 140UT-D	140MT-C-ASA11	
	X	0	X	21-22	N.C. Aux		140M-F	140M-C-ASA11	
	 Right Side-Mounted Auxiliary Contact <ul style="list-style-type: none"> <li>• 2-pole</li> <li>• Adds 9 mm to the width of the device</li> <li>• One per device</li> <li>• Not suitable for UL 489 applications</li> </ul>	0	X	0	33-34	N.O. Aux		140MT-C, D 140UT-D	140MT-C-ASA20
0		X	0	43-44	N.O. Aux	140M-F		140M-C-ASA20	
0		X	0	33-34	N.O. Aux		140MT-C, D 140UT-D	140MT-C-ASA02	
0		X	0	43-44	N.O. Aux		140M-F	140M-C-ASA02	
X		0	X	31-32	N.C. Aux		140MT-C, D 140UT-D	140MT-C-ASA11	
X		0	X	41-42	N.C. Aux		140M-F	140M-C-ASA11	
X		0	X	31-32	N.C. Aux		140MT-C, D 140UT-D	140MT-C-ASA02	
X		0	X	41-42	N.C. Aux		140M-F	140M-C-ASA02	
0		X	0	33-34	N.O. Aux		140MT-C, D 140UT-D	140MT-C-ASA11	
X		0	X	41-42	N.C. Aux		140M-F	140M-C-ASA11	
0		X	0	33-34	N.O. Aux		140MT-C, D 140UT-D	140MT-C-ASA02	
X		0	X	41-42	N.C. Aux		140M-F	140M-C-ASA02	

(1) X = Contact Closed; 0 = Contact Open

(2) Connection Diagram Reference:

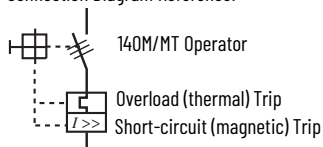

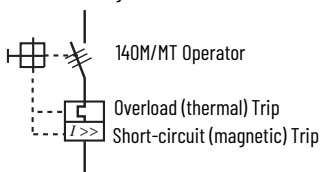

Table 35 - Trip Contacts

Description	Operator Position <sup>(1)</sup>			Term. No.	Contact Description	Connection Diagram <sup>(2)</sup>	For Use With	Cat. No.
	OFF	ON	Tripped					
 <p>Front-Mounted Trip Contact</p> <ul style="list-style-type: none"> <li>• 2-pole</li> <li>• Indicates tripping of device</li> <li>• No additional space required</li> </ul>	0	X	0	13-14	N.O. Aux		140MT-C, D 140UT-D	140MT-C-AFAR10A10
	0	0	X	27-28	N.O. Trip (short-circuit and overload)			
	0	X	0	13-14	N.O. Aux		140M-F	140M-C-AFAR10A10
	0	0	X	27-28	N.O. Trip (short-circuit and overload)			
	X	0	X	11-12	N.C. Aux		140MT-C, D 140UT-D	140MT-C-AFAR10A01
	0	0	X	27-28	N.O. Trip (short-circuit and overload)			
	X	0	X	11-12	N.C. Aux		140M-F	140M-C-AFAR10A01
	0	0	X	27-28	N.O. Trip (short-circuit and overload)			
	0	X	0	13-14	N.O. Aux		140MT-C, D 140UT-D	140MT-C-AFAR01A10
	X	X	0	25-26	N.C. Trip (short-circuit and overload)			
	0	0	X	17-18	N.O. Trip (short-circuit and overload)			140MT-C-AFAR10M10
	0	0	X	27-28	N.O. Trip (short-circuit)			
 <p>Right-Side Mounted Trip Contact</p> <ul style="list-style-type: none"> <li>• 2-pole</li> <li>• Indicates tripping of the device</li> <li>• Adds 9 mm to the width of the device</li> <li>• One only per device</li> <li>• A right-side mounted auxiliary contact may be tandem mounted on top of this trip contact</li> </ul>	0	0	X	57-58	N.O. Trip (short-circuit and overload)		140M-C-ASAR10M10	
	0	0	X	67-68	N.O. Trip (short-circuit)			
	0	0	X	57-58	N.O. Trip (short-circuit and overload)		140M-C-ASAR10M01	
	X	X	0	65-66	N.C. Trip (short-circuit)			
	X	X	0	55-56	N.C. Trip (short-circuit and overload)		140M-F	140M-C-ASAR01M10
	0	0	X	67-68	N.O. Trip (short-circuit)			
	X	X	0	55-56	N.C. Trip (short-circuit and overload)		140M-C-ASAR01M01	
	X	X	0	65-66	N.C. Trip (short-circuit)			
	0	0	X	77-78	N.O. Trip (short-circuit)		140M-C-ASAM11	
	X	X	0	65-66	N.C. Trip (short-circuit)			

(1) X = Contact Closed; 0 = Contact Open

(2) Connection Diagram Reference:

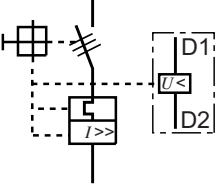

**Table 36 - Undervoltage Trip Units**

Description	Connection Diagram <sup>(1)</sup>	Trip Rating	For Use With	Cat. No.
 <p>Undervoltage Trip</p> <ul style="list-style-type: none"> <li>• Left-side mounted</li> <li>• Adds 18 mm to the width of the device</li> <li>• Automatically trips MPCB/MCP when voltage falls below 35...70%</li> </ul>		24V, 50 Hz/24...28V, 60 Hz	140MT-C, D 140UT-D	140MT-C-UXK
		120V, 60 Hz		140MT-C-UXD
		220...230V, 50 Hz		140MT-C-UXF
		240...260V, 60 Hz		140MT-C-UXA
		380...400V, 50 Hz		140MT-C-UXN
		480V, 60 Hz/415V, 50 Hz		140MT-C-UXB

(1) Connection Diagram Reference:

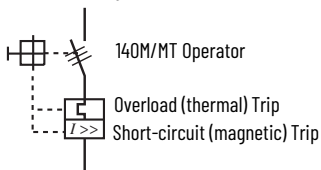

**Table 37 - Shunt Trip Units**

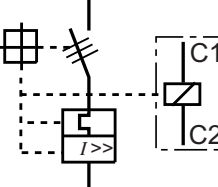
Description	Connection Diagram <sup>(1)</sup>	Trip Rating	For Use With	Cat. No.
 <p>Shunt Trip</p> <ul style="list-style-type: none"> <li>• Left-side mounted</li> <li>• Adds 18 mm to the width of the device</li> <li>• Provides remote tripping of the MPCB/MCP</li> <li>• Maximum on time for DC operated devices: 5 sec.</li> </ul>		24V, 50 Hz/24...28V, 60 Hz	140MT-C, D 140UT-D	140MT-C-SNK
		110V, 50 Hz/120V, 60 Hz		140MT-C-SND
		220...230V, 50 Hz		140MT-C-SNF
		240...260V, 60 Hz		140MT-C-SNA
		277V, 60 Hz		140MT-C-SNT
		380...400V, 50 Hz		140MT-C-SNN
		480V, 60 Hz/415V, 50 Hz		140MT-C-SNB
		24V DC		140MT-C-SNZJ



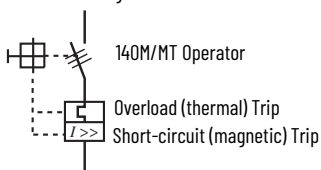





(1) Connection Diagram Reference:







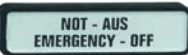

**Table 38 - Additional Accessories**

Description	For Use With	Cat. No.
 <p>Anti-Tamper Shield</p> <ul style="list-style-type: none"> <li>• Provides protection against inadvertent adjustment of the current setting</li> <li>• Must be ordered in multiples of 10 (10 pieces/package)</li> </ul>	140MT-C, D	140MT-C-CA
	140M-F	140M-C-CA



**Table 38 - Additional Accessories (Continued)**

	Description		For Use With	Cat. No.
	Lockable Twist Knob • For one padlock 4...6 mm (3/16 in.) diameter shackle • Can be locked in OFF position	Blue	140MT-C, D 140UT- D	140MT-C-KB
		Black		140MT-C-KN
		Red/Yellow		140MT-C-KRY
	Lockable Twist Knob • For one padlock 5 mm (3/16 in.) diameter shackle • Can be locked in OFF position	Black	140M-F	140M-C-KN1
		Red/Yellow		140M-C-KRY1
	Locking Tag • Padlock attachment to the lockable handles • Up to three padlocks 4...8 mm (5/16 in.) diameter shackle		140MT-C-KB 140MT-C-KN 140MT-C-KRY	140MT-C-M3
			140M-C-KN1 140M-C-KRY1	140M-C-M3
	Door Coupling Handle • For 3 padlocks 4...8 mm (5/16 in.) in diameter • IPX4 Protection/Type 1, 3R Interlock override capability • Can be modified for locking in ON position • Ships with coupling – order extension shaft and legend plate separately	Black	140MT-C, D 140UT- D	140MT-C-DN66
			140M-F	140M-C-DN66
		Red/Yellow	140MT-C, D 140UT- D	140MT-C-DRY66
			140M-F	140M-C-DRY66
	Extension Shaft (Short length) • Cut to required length for mounting depth (front of DIN Rail to front of enclosure door) 140MT-C: 136 mm (5.35 in) 140MT-D: 143 mm (5.63 in) 140UT-D: 143 mm (5.63 in) • For Cat. Nos. 140MT-C-DN66 and 140MT-C-DRY66 handles			140MT-C-DSS
	Extension Shaft (Standard length) • Cut to required length for mounting depth (front of DIN Rail to front of enclosure door) 140MT-C: 136...358 mm (5.35...14.1 in) 140MT-D: 143...364 mm (5.63...14.33 in) 140UT-D: 143...364 mm (5.63...14.33 in) • For Cat. Nos. 140MT-C-DN66 and 140MT-C-DRY66 handles		140MT-C, D 140UT- D	140MT-C-DS
	Extension Shaft (Extended length) • Cut to required length for mounting depth (front of DIN Rail to front of enclosure door) 140MT-C: 136...507 mm (5.35...19.96 in) 140MT-D: 143...513 mm (5.63...20.2 in) 140UT-D: 143...513 mm (5.63...20.2 in) • For Cat. Nos. 140MT-C-DN66 and 140MT-C-DRY66 handles			140MT-C-DSL
	Extension Shaft • Cut to required length for mounting depth (front of DIN Rail to front of enclosure door) • For Cat. Nos. 140M-C-DN66 and 140M-C-DRY66 handles	Standard Length		140M-C-DS
		Extended Length	140M-F	140M-C-DSL
	Door Coupling Handle • Type 3, 3R, 4, 4X, 12 (IP66) • For up to 2 padlocks • Fits in 30.5 mm cutout • Requires 140MT-C-DNC (140MT-C, 140MT-D, 140UT-D) or 140M-C-DNC (140M-F) coupler	Black	140MT-C, D 140UT- D	140MT-SB
			140M-F	140M-SB
		Red/Yellow	140MT-C, D 140UT- D	140MT-SY
			140M-F	140M-SY
	Extension Shaft • Cut to required length for mounting depth (front of DIN Rail to front of enclosure door)	12 in. (30.48 cm)	140MT-SB, 140MT-SY	140MT-S1
			140M-SB, 140M-SY	140M-S1
		21 in. (53.34 cm)	140MT-SB, 140MT-SY	140MT-S2
			140M-SB, 140M-SY	140M-S2



**Table 38 - Additional Accessories (Continued)**

	Description	For Use With	Cat. No.	
	Coupler • Included with Cat. Nos. 140MT-C-DN66 and 140MT-C-DRY66	140MT-C, D 140UT- D	140MT-C-DNC	
	Coupler • Included with Cat. Nos. 140M-C-DN66 and 140M-C-DRY66	140M-F	140M-C-DNC	
	Extension Shaft Support • Provides consistent alignment of the 140M/MT-C-DS and 140M/MT-C-DSL shafts with the 140M/MT-C-DN66 or 140M/MT-C-DRY66 door coupling handles • Recommended for shaft lengths >200 mm • Snaps on the right side of the 140MT-C, -D, 140M-F, or 140UT-D device and allows the addition of one side-mounted auxiliary contact. • Width: 9 mm. • For use with screw-mounted or hat rail mounted devices.	140MT-C, D 140UT- D	140MT-C-SHS	
		140M-F	140M-C-SHS	
	Legend Plate	Marking: "Hauptschalter" and "Main Switch"	140MT-C-DN66	140MT-C-DFCN
			140M-C-DN66	140M-C-DFCN
		Marking: "Not-Aus" and "Emergency Off"	140MT-C-DRY66	140MT-C-DFCRY
			140M-C-DRY66	140M-C-DFCRY
	Screw Adapter • For screw arrangement of a motor protection circuit breaker • Must be ordered in multiples of 10 (10 pieces/pkg)	140MT-C, D 140UT- D	140MT-C-N45	
		140M-F	140M-C-N45	

**Table 39 - Modules and Adapters**

	Description	For Use With	Cat. No.
	ECO Connecting Module – 12 A (IEC), 11 A (UL) • For DOL and reversing starters • Eco-starters mount on single DIN Rail (140MT on DIN Rail) • Electrical and mechanical interconnection of 140MT and 100-K contactors	140MT-C to 100-K	140MT-C-PEK12
	ECO Connecting Modules – 18 A (IEC), 17 A (UL) • Eco-starters mount on single DIN Rail (140MT on DIN Rail) • Electrical and mechanical interconnection of 140MT MPCB and 100-E contactors	140MT-C to 100(S)-E09...16 <sup>(1)</sup>	140MT-C-PE16
		140MT-C to 100(S)-E09QJ...16QJ	140MT-C-PSE16
		140MT-D to 100(S)-E09...16 <sup>(1)</sup>	140MT-D-PE16
		140MT-D to 100(S)-E09QJ...16QJ	140MT-D-PSE16
	ECO Connecting Modules – 23 A (IEC), 22 A (UL) • Eco-starters mount on single DIN Rail (140MT on DIN Rail) • Electrical and mechanical interconnection of 140MT MPCB and 100-C contactors	140MT-C to 100-C09...C23	140MT-C-PEC23
		140MT-D to 100-C09...C23	140MT-D-PEC23
	ECO Connecting Modules – 30 A (IEC), 30 A (UL) • Eco-starters mount on single DIN Rail (140MT on DIN Rail) • Electrical and mechanical interconnection of 140MT MPCB and 100-C contactors	140MT-D to 100-C30...C37	140MT-D-PEC37
	ECO Connecting Modules – 40 A (IEC), 34 A (UL) • Eco-starters mount on single DIN Rail (140MT on DIN Rail) • Electrical and mechanical interconnection of 140MT MPCB and 100-E contactors	140MT-C to 100(S)-E26...38 <sup>(1)</sup>	140MT-C-PE38
		140MT-C to 100(S)-E26QJ...38QJ	140MT-C-PSE38
140MT-D to 100(S)-E26...38 <sup>(1)</sup>		140MT-D-PE38	
140MT-D to 100(S)-E26QJ...38QJ		140MT-D-PSE38	
	Connecting Modules – 23 A (IEC), 30 A (UL) and 30 A (IEC), 30 A (UL) • Contactor and MPCB MUST BE mounted separately on (2) DIN Rails Electrical interconnection of 140MT and 100-C (with AC coils)	140MT-C to 100-C09...C23	140MT-C-PNC23
		140MT-D to 100-C09...C23	140MT-D-PNC23
		140MT-D to 100-C30...C37	140MT-D-PNC37
	Connecting Modules – 25 and 45 A • Contactor and MPCB MUST BE mounted separately on (2) DIN Rails Electrical interconnection of 140M-F and 100-C (with AC coils)	140M-F to 100-C30...C37	140M-F-PNC37
		140M-F to 100-C43	140M-F-PNC43
		140M-F to 100-C30...C43	140M-F-PSC43

**Table 39 - Modules and Adapters (Continued)**





	Description	For Use With	Cat. No.
	Coil Extension Modules • Provides access to coil terminals on 3-component starters	100-C09...C23 contactors	140MT-C-PSC23
		100-C30...C55 contactors	140MT-F-PSC43
	Spacing Adapter • Required for self-protected combination motor controller (Type E) applications of Bul. 140MT-C, -D, and 140M-F MPCBs. Not for use with bus bars.	140MT-C, -D	140MT-C-TE
		140M-F	140M-F-TE

(1) Not suitable for 100(S)-E09...380J or 300(S)-T0...B00J contactors.

**Table 40 - Other Accessories**

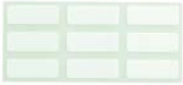
	Description	For Use With	Cat. No.	
	Feeder Block for Compact Busbar • Supply of compact busbars • Increases terminal capacity	140MT-C	140MT-C-WBE	
		140M-F	140M-F-WBE	
	Feeder Terminal for Compact Busbar • For supply of compact busbars • Top feed – overlaps compact busbar • Meets UL Type E spacing requirements	140MT-C, -D	140MT-C-WTEN	
		140M-F	140M-F-WTE	
	Three-phase Compact Busbar for MPCBs – 64 A Max Continuous Current • 45 mm (1.77 in.) spacing • For use with front-mounted auxiliary contact	2 connections	140MT-C, -D	140MT-C-W452
		3 connections		140MT-C-W453
		4 connections		140MT-C-W454
		5 connections		140MT-C-W455
	Three-phase Compact Busbar for MPCBs – 64 A Max Continuous Current • 54 mm (2.13 in.) spacing • For use with side-mounted auxiliary contact	2 connections	140MT-C, -D	140MT-C-W542
		3 connections		140MT-C-W543
		4 connections		140MT-C-W544
		5 connections		140MT-C-W545
	Three-phase Compact Busbar for 45 A Motor Protection Circuit Breakers – 115 A Max. Continuous Current • 54 mm (2.13 in.) spacing • For use with front-mounted auxiliary contact	2 connections	140M-F	140M-F-W542
		3 connections		140M-F-W543
		4 connections		140M-F-W544
	Three-phase Compact Busbar for 45 A Motor Protection Circuit Breakers – 115 A Max. Continuous Current • 63 mm spacing • For use with side-mounted auxiliary contact	2 connections	140M-F	140M-F-W632
		3 connections		140M-F-W633
		4 connections		140M-F-W634
	Terminal Cover • For covering of unused compact bus bar terminals IP2X finger protection • Must be ordered in multiples of 10 • 10 pieces/pkg	140MT-C, -D	140MT-C-WSN	
		140M-F	140M-F-WS	
	Top Hat Rail Adapter – 10 mm • Adjusts the depth of the 140MT-C to the 140MT-D • Allows the use of compact busbars across both frame sizes • Must be ordered in multiples of 10 • 10 pieces/pkg	140MT-C	140MT-KBH	
	DIN (#3) symmetrical hat rail • 35 mm x 7.5 mm x 1 m (1.4 x 0.3 x 39 in.) long • 10 pieces/package	140MT-C, -D 140UT-D 140M-F	199-DR1	
	DIN (#3) Symmetrical Rail • 35 mm x 15 mm x 1 m (1.4 x 0.6 x 39 in.) long • Top Hat Rail (DIN #3 Symmetrical Rail) • 5 pieces/package	140MT-C, -D 140UT-D 140M-F	1492-DR9	

**Table 40 - Other Accessories (Continued)**

	Description		For Use With	Cat. No.
	Label Sheet • 105 self-adhesive paper labels each, 6 x 17 mm (0.236 x 0.67 in)	Pkg. qty. 10	140MT-C, -D 140M-F	100-FMS
	Self-adhesive Markers • 40 markers/card • Package qty. 5 cards	each label 6 x 15 mm (0.236 x 0.59 in)	140MT-C, -D 140M-F	1492-MAS6X15
	Adhesive labels • White, halogen-free polyester, with acrylate adhesive • Ambient temperature range -40...+120 °C (-40...+248 °F) • Qty: 3000/roll	each label 6 x 17 mm (0.236 x 0.67 in)	140MT-C, -D 140M-F	1492-MDM6X17-W
		each label 8 x 20 mm (0.315 x 0.787 in)	140MT-C, -D 140M-F	1492-MDM8X20-W

# Specifications

**Table 41 - General Data**

Attribute			140MT-C	140MT-D	140M-F	
Standards compliance		IEC	IEC/EN 60947-2, IEC/EN 60947-4-1			
		cULus	UL 60947-4-1, CSA C22.2, No. 60947-4-1			
Certifications		Regional	cULus Listed (File No. E54612, NLRV(7); E205542, NKJH(7); E518407			
			CCC, EAC, CE, IEC, CB Scheme		CCC, EAC, CE	
Rated Insulation Voltage $U_i$	IEC	[V]	690			
	UL/CSA	[V]	600			
Rated Impulse Withstand Voltage $U_{imp}$		Pollution degree	3			
		Main circuits $U_{imp}$ /Overtoltage Category	6 kV/III, 8 kV (Disconnect)			
		Auxiliary circuits $U_{imp}$ /Overtoltage Category	6 kV/III			
Rated Frequency		[Hz]	45-65			
Utilization Category		IEC 60947-2 (Circuit breaker)	A			
		IEC 60947-4-1 (Motor starter)	AC-3			
Life Span		Mechanical [operations]	100,000	30,000		
		Electrical ( $I_e$ max.) [operations]	100,000	30,000		
Switching Frequency		[operations/hour]	max. 25			
Ambient Temperature		Storage [°C (°F)]	-40...+85 (-40...185)			
		Operation [°C (°F)]	-25...+70 (-13...158)			
Climatic resistance		Operating Humidity/Moisture heat (60068-2-3)	5...95% Non-condensing			
Site Altitude		[m]	to 2000 N.N. (6561 ft)			
Protection Class			IP2X from all directions			
Resistance to Shock, Transport (60068-2-27)		ON	15 G/11 ms			
		OFF	30 G/11 ms			
Resistance to Vibration, Operation (60068-2-6)			5 G			
Rated Thermal Current $I_{th}$		up to 40 °C (104 °F) ambient temperature	[A]	0.1...32	0.63...40	6.3...45
		up to 60 °C (140 °F) ambient temperature	[A]	0.1...32	0.63...40	6.3...45
Rated Supply Current $I_e$			[A]	0.1...32	0.63...40	6.3...45
Dependence on Temperature		40 °C (104 °F)	[A]	no reduction		
		50 °C (122 °F)	[A]	no reduction		
		60 °C (140 °F)	[A]	no reduction		
		70 °C (158 °F)	[A]	15% current reduction of the upper rated current $I_e$		
Overload Protection Characteristics			IEC 60947-4-1 Motor protection (except Cat. Nos. 140MT-D9N, 140M-F9N)			
Ambient Temperature Compensation		[°C (°F)]	-25...+60 (-13...+140)			
Phase-loss Protection			Differential release			
Trip class			10 (except Cat. Nos. 140MT-D9N, 140M-F8N) fixed setting			
Magnetic Release			fixed setting			
Release current ( $\pm 20\%$ )		for E, N Version	[A]	$14 \times I_e$ max. <sup>(1)</sup>	$13 \times I_e$ max	
		for E, N Version C36, C40	[A]	$12 \times I_e$ max. <sup>(1)</sup>	—	
		for T Version	[A]	$18...22 \times I_e$ max. <sup>(2)</sup>		
Total Power loss $P_v$		Circuit Breaker at rated load/operating temp.	[W]	4...11	4...14	7...22
Main Disconnect Switch Application			Yes, with accessories			
Application Conditions		140MT-D...C36, -C40: Suitable for continuous operation at 90% current rating at 480V only if used in a minimum enclosure size of 250 x 175 x 150 mm (10 x 7 x 6 in).				
		For utilization outside North America, assemblies (of products) shall comply to the IEC 61439-1 requirements				
		140M and 140MT manual motor starters are intended for use in closed areas without hazardous operating conditions such as dust or explosive or corrosive gases. Enclosures of appropriate manner need to be in place to protect devices in such environments. See <a href="#">Table 42</a> .				

 (1)  $I_e$  max. = maximum values of setting ranges fixed magnetic setting for 140MT-D9V; see ratings.







 (2)  $I_e$  max. = maximum values of setting ranges; see ratings.



Table 42 - Minimum Enclosure Size for 140MT-C and 140MT-D Devices

Rated Current [A]		Application Type			
		480V Group Installation and At-motor Disconnect	600V Group Installation and At-motor Disconnect	480Y/277V Self-protected (Type E) Combination Motor Controller	600Y/347V Self-protected (Type E) Combination Motor Controller
≤ 6.3	[mm]	166 x 68 x 125	166 x 68 x 125	166 x 68 x 125	166 x 68 x 125
	[in]	6.5 x 2.7 x 5	6.5 x 2.7 x 5	6.5 x 2.7 x 5	6.5 x 2.7 x 5
10...16	[mm]	166 x 68 x 125	166 x 68 x 125	200 x 68 x 125	250 x 68 x 125
	[in]	6.5 x 2.7 x 5	6.5 x 2.7 x 5	7.9 x 2.7 x 5	10 x 2.7 x 5
20...32	[mm]	166 x 68 x 125	250 x 68 x 125	200 x 68 x 125	-
	[in]	6.5 x 2.7 x 5	10 x 2.7 x 5	7.9 x 2.7 x 5	
36...40	[mm]	250 x 175 x 150	250 x 175 x 150	250 x 175 x 150	
	[in]	10 x 7 x 6	10 x 7 x 6	10 x 7 x 6	

Table 43 - MPCB Connecting Characteristics

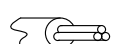
Connection		No. of Conductors	140MT-C, 140MT-D ≤ 16 A	140MT-C, 140MT-D > 16 A	140M-F
Type of terminals					
			Screw Clamp up to 16 A, M4	Screw Clamp greater than 16 A, M4	
Connection Screw			Pozidriv No.2/Blade No.3	Pozidriv No.2/Blade No.3	Pozidriv No.2/Blade No.3
Wiring	Solid or stranded 	1	1...6 mm <sup>2</sup>	1.5...10 mm <sup>2</sup>	2.5...25 mm <sup>2</sup>
		2	1...2.5 mm <sup>2</sup> 2.5...6 mm <sup>2</sup>	1.5...4 mm <sup>2</sup> 4...10 mm <sup>2</sup>	2.5...25 mm <sup>2</sup>
	Flexible with ferrule (end sleeve) 	1	1...6 mm <sup>2</sup>	1.5...10 mm <sup>2</sup>	2.5...25 mm <sup>2</sup>
		2	1...2.5 mm <sup>2</sup> 2.5...4 mm <sup>2</sup>	1.5...4 mm <sup>2</sup> 4...10 mm <sup>2</sup>	2.5...25 mm <sup>2</sup>
	Finely stranded 	1	1.5...6 mm <sup>2</sup>	2.5...10 mm <sup>2</sup>	16...25 mm <sup>2</sup>
		2	1.5...4 mm <sup>2</sup> 2.5...6 mm <sup>2</sup>	2.5...6 mm <sup>2</sup> 4...10 mm <sup>2</sup>	16...25 mm <sup>2</sup>
	Cross section per UL/CSA solid, stranded 	1	No. 14...10 AWG	No. 14...8 AWG	No.14...8
		2	No. 14...10 AWG	No. 14...10 AWG No. 12...8 AWG	No.14...8
Stripping length			10 mm (0.39 in.)	10 mm (0.39 in.)	10 mm (0.39 in.)
Tightening torques		[N•m]/[lb•in]	2...2.5/18...22	2...2.5/18...22	3...3.5/27...30

## Combination Ratings

### Bulletin 140MT Devices with Bulletin 100-K Miniature IEC Contactors

Table 44 - UL 60947 Application Ratings, MPSDs and MCPs with Bulletin 100-K Miniature IEC Contactors

Cat. No.	UL 60947-4-1 Manual Motor Controller						UL 60947-4-1 Type F		
	Max. Fuse or Circuit Breaker per NEC [A]	Minimum Contactor Size <sup>(1)</sup>	Group Motor Installation		Motor Disconnect		Combination Motor Controller		
			Max Short-circuit Current [kA]		Max Short-circuit Current [kA]		Minimum Contactor Size <sup>(1)</sup>	Max Short-circuit Current [kA]	
			480V	600V	480V	600V		480Y/277V <sup>(2)</sup>	600Y/347V <sup>(2)</sup>
<b>C-Frame, Adjustable Thermal/Fixed Magnetic (14 x I<sub>n</sub>)</b>									
140MT-C3E-A16	450	100-K05	65	50	65	50	100-K05	65	50
140MT-C3E-A25	450	100-K05	65	50	65	50	100-K05	65	50
140MT-C3E-A40	450	100-K05	65	50	65	50	100-K05	65	50
140MT-C3E-A63	450	100-K05	65	50	65	50	100-K05	65	50
140MT-C3E-B10	450	100-K05	65	50	65	50	100-K05	65	50
140MT-C3E-B16	450	100-K05	65	50	65	50	100-K05	65	50
140MT-C3E-B25	450	100-K05	65	30	65	30	100-K05	65	30
140MT-C3E-B40	450	100-K05	65	30	65	30	100-K05	65	30
140MT-C3E-B63	450	100-K05	65	30	65	30	100-K05	65	—
140MT-C3E-C10	450	100-K09	65	30	65	30	100-K09	65	—
140MT-C3E-C16	450	100-K12	30	30	30	30	100-K12	30	—
<b>D-Frame, Adjustable Thermal/Fixed Magnetic (14 x I<sub>n</sub>)</b>									
140MT-D9E-A63	450	100-K05	65	50	65	50	100-K05	65	50
140MT-D9E-B10	450	100-K05	65	50	65	50	100-K05	65	50
140MT-D9E-B16	450	100-K05	65	50	65	50	100-K05	65	50
140MT-D9E-B25	450	100-K05	65	30	65	30	100-K05	65	30
140MT-D9E-B40	450	100-K05	65	30	65	30	100-K05	65	30
140MT-D9E-B63	450	100-K05	65	30	65	30	100-K05	65	30
140MT-D9E-C10	450	100-K09	65	30	65	30	100-K09	65	30
140MT-D9E-C16	450	100-K12	65	30	65	30	100-K12	65	30

(1) Similar for other contactor configurations (100-K, 104-K)

(2) For full voltage (delta) ratings above 277V or 347V, follow the NEC or CEC rules for group motor applications.

Table 45 - IEC 60947-4-1, Type 1 Coordination Ratings, MPSDs with Bulletin 100-K IEC Contactors

Cat. No.	415V	
	Max Short-circuit Current [kA]	Min Contactor Size <sup>(1)</sup>
<b>C-Frame, Adjustable Thermal/Fixed Magnetic (14 x I<sub>n</sub>)</b>		
140MT-C3E-A16	65	100-K05
140MT-C3E-A25	65	100-K05
140MT-C3E-A40	65	100-K05
140MT-C3E-A63	65	100-K05
140MT-C3E-B10	65	100-K05
140MT-C3E-B16	65	100-K05
140MT-C3E-B25	65	100-K05
140MT-C3E-B40	65	100-K05
140MT-C3E-B63	65	100-K05
140MT-C3E-C10	65	100-K09
140MT-C3E-C16	30	100-K12
<b>D-Frame, Adjustable Thermal/Fixed Magnetic (14 x I<sub>n</sub>)</b>		
140MT-D9E-A63	65	100-K05
140MT-D9E-B10	65	100-K05
140MT-D9E-B16	65	100-K05
140MT-D9E-B25	65	100-K05
140MT-D9E-B40	65	100-K05
140MT-D9E-B63	65	100-K05
140MT-D9E-C10	65	100-K09
140MT-D9E-C16	65	100-K12

(1) Similar for other contactor configurations (100-K, 104-K)

## Bulletin 140MT/M Devices with Bulletin 100-C IEC Contactors

Table 46 - UL 60947 Application Ratings, MPSDs with Bulletin 100-C IEC Contactors

Cat. No.	UL 60947-4-1 Manual Motor Controller						UL 60947-4-1 Type F		
	Max. Fuse or Circuit Breaker per NEC [A]	Minimum Contactor Size <sup>(1)</sup>	Group Motor Installation		Motor Disconnect		Combination Motor Controller		
			Max Short-circuit Current [kA]		Max Short-circuit Current [kA]		Minimum Contactor Size <sup>(1)</sup>	Max Short-circuit Current [kA]	
			480V	600V	480V	600V		480V/277V <sup>(2)</sup>	600V/347V <sup>(2)</sup>
<b>C-Frame, Adjustable Thermal/Fixed Magnetic (14 x I<sub>n</sub>)</b>									
140MT-C3E-A16	450	100-C09	65	50	65	50	100-C09	65	50
140MT-C3E-A25	450	100-C09	65	50	65	50	100-C09	65	50
140MT-C3E-A40	450	100-C09	65	50	65	50	100-C09	65	50
140MT-C3E-A63	450	100-C09	65	50	65	50	100-C09	65	50
140MT-C3E-B10	450	100-C09	65	50	65	50	100-C09	65	50
140MT-C3E-B16	450	100-C09	65	50	65	50	100-C09	65	50
140MT-C3E-B25	450	100-C09	65	30	65	30	100-C09	65	30
140MT-C3E-B40	450	100-C09	65	30	65	30	100-C09	65	30
140MT-C3E-B63	450	100-C09	65	30	65	30	100-C09	65	—
140MT-C3E-C10	450	100-C09	65	30	65	30	100-C09	65	—
140MT-C3E-C16	450	100-C12	30	30	30	30	100-C12	30	—
140MT-C3E-C20	450	100-C16	30	30	30	10	—	—	—
140MT-C3E-C25	450	100-C23	30	18	10	5	—	—	—
	450	100-C30	30	18	30	5	—	—	—
140MT-C3E-C29	450	100-C30	30	10	10	—	—	—	—
140MT-C3E-C32	450	100-C37	30	10	10	—	—	—	—
<b>D-Frame, Adjustable Thermal/Fixed Magnetic (14 x I<sub>n</sub>)</b>									
140MT-D9E-A63	450	100-C09	65	50	65	50	100-C09	65	50
140MT-D9E-B10	450	100-C09	65	50	65	50	100-C09	65	50
140MT-D9E-B16	450	100-C09	65	50	65	50	100-C09	65	50
140MT-D9E-B25	450	100-C09	65	30	65	30	100-C09	65	30
140MT-D9E-B40	450	100-C09	65	30	65	30	100-C09	65	30
140MT-D9E-B63	450	100-C09	65	30	65	30	100-C09	65	30
140MT-D9E-C10	450	100-C09	65	30	65	30	100-C09	65	30
140MT-D9E-C16	450	100-C12	65	30	65	30	100-C12	65	30
140MT-D9E-C20	450	100-C23	65	30	65	30	100-C23	65	—
140MT-D9E-C25	450	100-C23	50	30	50	30	100-C23	50	—
140MT-D9E-C29	450	100-C30	50	30	50	30	100-C30	50	—
140MT-D9E-C32	450	100-C37	50	30	30	18	100-C37	30	—
140MT-D9E-C36	450	100-C37	30	30	30	18	100-C37	30	—
140MT-D9E-C40	450	100-C37	30	30	30	18	100-C37	30	—
<b>F-Frame, Adjustable Thermal/Fixed Magnetic (13 x I<sub>n</sub>)</b>									
140M-F8E-C10	600	100-C30	65	30	65	30	100-C30	65	30
140M-F8E-C16	600	100-C30	65	30	65	30	100-C30	65	30
140M-F8E-C20	600	100-C30	65	30	65	30	100-C30	65	30
140M-F8E-C25	600	100-C30	65	30	65	30	100-C30	65	30
140M-F8E-C32	600	100-C30	65	30	65	30	100-C30	65	30
140M-F8E-C45	600	100-C37	65	18	65	18	100-C37	65	—

(1) Similar for other contactor configurations (100-C, 104-C, 100S-C, 104S-C)  
 (2) For full-voltage (delta) ratings above 277V or 347V, follow the NEC or CEC rules for group motor applications.

Table 47 - UL 60947 Application Ratings, MCPs with Bulletin 100-C IEC Contactors

Cat. No.	UL 60947-4-1 Manual Motor Controller					
	Max. Fuse or Circuit Breaker per NEC [A]	Minimum Contactor Size	Group Motor Installation		Motor Disconnect	
			Max Short-circuit Current [kA]		Max Short-circuit Current [kA]	
			480V	600V	480V	600V
<b>D-Frame, Motor Circuit Protectors, Fixed Magnetic (14 x I<sub>n</sub>)</b>						
140MT-D9N-A16	450	100-C09	65	50	65	50
140MT-D9N-A25	450	100-C09	65	50	65	50
140MT-D9N-A40	450	100-C09	65	50	65	50
140MT-D9N-A63	450	100-C09	65	50	65	50
140MT-D9N-B10	450	100-C09	65	50	65	50
140MT-D9N-B16	450	100-C09	65	50	65	50
140MT-D9N-B25	450	100-C09	65	30	65	30
140MT-D9N-B40	450	100-C09	65	30	65	30
140MT-D9N-B63	450	100-C09	65	30	65	30
140MT-D9N-C10	450	100-C09	65	30	65	30
140MT-D9N-C16	450	100-C12	65	30	65	30
140MT-D9N-C20	450	100-C23	65	30	65	30
140MT-D9N-C25	450	100-C23	50	30	50	30
140MT-D9N-C29	450	100-C30	50	30	50	30
140MT-D9N-C32	450	100-C37	50	30	30	18
140MT-D9N-C36	450	100-C37	30	30	30	18
140MT-D9N-C40	450	100-C37	30	30	30	18
<b>F-Frame, Motor Circuit Protectors, Fixed Magnetic (13 x I<sub>n</sub>)</b>						
140M-F8N-C25	600	100-C23	65	30	65	30
140M-F8N-C32	600	100-C30	65	30	65	30
140M-F8N-C45	600	100-C37	65	18	65	18

Table 48 - IEC 60947-4-1, Type 2 Coordination Ratings, MPSDs with Bulletin 100-C IEC Contactors

Cat. No.			400V		480V		600V	
Standard Motor Protection	High Inrush Motor Protection	Motor Circuit Protection	Max Short-circuit Current [kA]	Min Contactor Size <sup>(1)</sup>	Max Short-circuit Current [kA]	Min Contactor Size <sup>(1)</sup>	Max Short-circuit Current [kA]	Min Contactor Size <sup>(1)</sup>
<b>C-Frame, Adjustable Thermal/Fixed Magnetic (14 x I<sub>n</sub>)</b>								
140MT-C3E-A16	—	—	100	100-C09	—	—	—	—
140MT-C3E-A25	—	—	100	100-C09	—	—	—	—
140MT-C3E-A40	—	—	100	100-C09	—	—	—	—
140MT-C3E-A63	—	—	100	100-C09	—	—	—	—
140MT-C3E-B10	—	—	100	100-C09	—	—	—	—
140MT-C3E-B16	—	—	100	100-C09	—	—	—	—
140MT-C3E-B25	—	—	65	100-C23	—	—	—	—
140MT-C3E-B40	—	—	65	100-C23	—	—	—	—
140MT-C3E-B63	—	—	65	100-C23	—	—	—	—
140MT-C3E-C10	—	—	65	100-C23	—	—	—	—
140MT-C3E-C16	—	—	50	100-C30	—	—	—	—
140MT-C3E-C20	—	—	50	100-C30	—	—	—	—
140MT-C3E-C25	—	—	15	100-C30	—	—	—	—
140MT-C3E-C29	—	—	15	100-C30	—	—	—	—
140MT-C3E-C32	—	—	15	100-C30	—	—	—	—
<b>D-Frame, Adjustable Thermal/Fixed Magnetic (14 x I<sub>n</sub>)</b>								
140MT-D9E-A63	—	—	100	100-C09	—	—	—	—
140MT-D9E-B10	140MT-D9T-A63	140MT-D9N-B10	100	100-C09	—	—	—	—
140MT-D9E-B16	140MT-D9T-B10	140MT-D9N-B16	100	100-C09	—	—	—	—
140MT-D9E-B25	140MT-D9T-B16	140MT-D9N-B25	100	100-C09	—	—	—	—
140MT-D9E-B40	140MT-D9T-B25	140MT-D9N-B40	65	100-C09	—	—	—	—
140MT-D9E-B63	140MT-D9T-B40	140MT-D9N-B63	65	100-C09	—	—	—	—
140MT-D9E-C10	140MT-D9T-B63	140MT-D9N-C10	65	100-C09	—	—	—	—
140MT-D9E-C16	140MT-D9T-C10	140MT-D9N-C16	65	100-C23	—	—	—	—
140MT-D9E-C20	140MT-D9T-C16	140MT-D9N-C20	65	100-C23	—	—	—	—
140MT-D9E-C25	140MT-D9T-C20	140MT-D9N-C25	65	100-C23	—	—	—	—
140MT-D9E-C29	140MT-D9T-C25	140MT-D9N-C29	65	100-C30	—	—	—	—
140MT-D9E-C32	140MT-D9T-C29	140MT-D9N-C32	65	100-C30/C37	—	—	—	—
140MT-D9E-C36	140MT-D9T-C32	—	65	100-C30/C37	—	—	—	—
140MT-D9E-C40	140MT-D9T-C36	140MT-D9N-C40	65	100-C30/C37	—	—	—	—
<b>F-Frame, Adjustable Thermal/Fixed Magnetic (13 x I<sub>n</sub>)</b>								
140M-F8E-C10	—	—	100	100-C09	65	100-C09	30	100-C30
140M-F8E-C16	—	—	100	100-C12	65	100-C12	30	100-C30
140M-F8E-C20	—	—	100	100-C23	65	100-C23	30	100-C30
140M-F8E-C25	—	140M-F8N-C25	100	100-C30	65	100-C30	30	100-C30
140M-F8E-C32	140M-F8T-C25	140M-F8N-C32	100	100-C30	65	100-C30	30	100-C30
140M-F8E-C45	140M-F8T-C32	140M-F8N-C45	100	100-C37	65	100-C37	10	100-C37

(1) Similar for other contactor configurations (100-C, 104-C, 100S-C, 104S-C)

## Bulletin 140MT/M Devices with Bulletin 100-E IEC Contactors

Table 49 - UL 60947 Application Ratings, MPSDs with Bulletin 100-E IEC Contactors

Cat. No.	UL 60947-4-1 Manual Motor Controller						UL 60947-4-1 Type F		
	Max. Fuse or Circuit Breaker per NEC [A]	Minimum Contactor Size <sup>(1)</sup>	Group Motor Installation		Motor Disconnect		Combination Motor Controller		
			Max Short-circuit Current [kA]		Max Short-circuit Current [kA]		Minimum Contactor Size <sup>(1)</sup>	Max Short-circuit Current [kA]	
			480V	600V	480V	600V		480Y/277V <sup>(2)</sup>	600Y/347V <sup>(2)</sup>
<b>C-Frame, Adjustable Thermal/Fixed Magnetic (14 x I<sub>n</sub>)</b>									
140MT-C3E-A16	450	100-E09	65	50	65	50	100-E09	65	50
140MT-C3E-A25	450	100-E09	65	50	65	50	100-E09	65	50
140MT-C3E-A40	450	100-E09	65	50	65	50	100-E09	65	50
140MT-C3E-A63	450	100-E09	65	50	65	50	100-E09	65	50
140MT-C3E-B10	450	100-E09	65	50	65	50	100-E09	65	50
140MT-C3E-B16	450	100-E09	65	50	65	50	100-E09	65	50
140MT-C3E-B25	450	100-E09	65	30	65	30	100-E09	65	30
140MT-C3E-B40	450	100-E09	65	30	65	30	100-E09	65	30
140MT-C3E-B63	450	100-E09	65	30	65	30	100-E09	65	—
140MT-C3E-C10	450	100-E09	65	30	65	30	100-E09	65	—
140MT-C3E-C16	450	100-E12	30	30	30	30	100-E12	30	—
140MT-C3E-C20	450	100-E16	30	30	30	10	—	—	—
140MT-C3E-C25	450	100-E26	30	18	10	5	—	—	—
	450	100-E30	30	18	30	5	—	—	—
140MT-C3E-C29	450	100-E30	30	10	10	—	—	—	—
140MT-C3E-C32	450	100-E38	30	10	10	—	—	—	—
<b>D-Frame, Adjustable Thermal/Fixed Magnetic (14 x I<sub>n</sub>)</b>									
140MT-D9E-A63	450	100-E09	65	50	65	50	100-E09	65	50
140MT-D9E-B10	450	100-E09	65	50	65	50	100-E09	65	50
140MT-D9E-B16	450	100-E09	65	50	65	50	100-E09	65	50
140MT-D9E-B25	450	100-E09	65	30	65	30	100-E09	65	30
140MT-D9E-B40	450	100-E09	65	30	65	30	100-E09	65	30
140MT-D9E-B63	450	100-E09	65	30	65	30	100-E09	65	30
140MT-D9E-C10	450	100-E09	65	30	65	30	100-E09	65	30
140MT-D9E-C16	450	100-E12	65	30	65	30	100-E12	65	30
140MT-D9E-C20	450	100-E26	65	30	65	30	100-E26	65	—
140MT-D9E-C25	450	100-E26	50	30	50	30	100-E26	50	—
140MT-D9E-C29	450	100-E30	50	30	50	30	100-E30	50	—
140MT-D9E-C32	450	100-E38	50	30	30	18	100-E38	30	—
140MT-D9E-C36	450	100-E38	30	30	30	18	100-E38	30	—
140MT-D9E-C40	450	100-E38	30	30	30	18	100-E38	30	—
140MT-D9E-C40	450	100-E40	30	30	30	18	100-E40	30	—

(1) Similar for other contactor configurations (100-E, 104-E, 100S-E, 104S-E)  
 (2) For full-voltage (delta) ratings above 277V or 347V, follow the NEC or CEC rules for group motor applications.

Table 50 - IEC 60947-4-1, Type 2 Coordination Ratings, MPSDs with Bulletin 100-E IEC Contactors







Cat. No.		415V	
Standard Motor Protection	High Inrush Motor Protection	Max Short-circuit Current [kA]	Min Contactor Size <sup>(1)</sup>
<b>C-Frame, Adjustable Thermal/Fixed Magnetic (14 x I<sub>n</sub>)</b>			
140MT-C3E-A16	—	100	100-E09
140MT-C3E-A25	—	100	100-E09
140MT-C3E-A40	—	100	100-E09
140MT-C3E-A63	—	100	100-E09
140MT-C3E-B10	—	100	100-E09
140MT-C3E-B16	—	100	100-E09
140MT-C3E-B25	—	65	100-E26
140MT-C3E-B40	—	65	100-E26
140MT-C3E-B63	—	65	100-E26
140MT-C3E-C10	—	65	100-E26
140MT-C3E-C16	—	50	100-E26
140MT-C3E-C20	—	50	100-E26
140MT-C3E-C25	—	15	100-E30
140MT-C3E-C29	—	15	100-E30
140MT-C3E-C32	—	15	100-E30
<b>D-Frame, Adjustable Thermal/Fixed Magnetic (14 x I<sub>n</sub>)</b>			
140MT-D9E-A63	—	100	100-E09
140MT-D9E-B10	—	100	100-E09
140MT-D9E-B16	—	100	100-E09
140MT-D9E-B25	—	100	100-E09
140MT-D9E-B40	—	65	100-E26
140MT-D9E-B63	—	65	100-E26
140MT-D9E-C10	—	65	100-E26
140MT-D9E-C16	—	65	100-E26
140MT-D9E-C20	—	65	100-E26
140MT-D9E-C25	—	65	100-E26
140MT-D9E-C29	—	65	100-E26
140MT-D9E-C32	—	65	100-E30
140MT-D9E-C36	—	65	100-E30
140MT-D9E-C40	—	66	100-E30
140MT-D9E-C40	—	65	100-E40
—	140MT-D9T-A63	100	100-E09
—	140MT-D9T-B10	100	100-E09
—	140MT-D9T-B16	100	100-E09
—	140MT-D9T-B25	65	100-E26
—	140MT-D9T-B40	65	100-E26
—	140MT-D9T-B63	65	100-E26
—	140MT-D9T-C10	65	100-E26
—	140MT-D9T-C16	65	100-E26
—	140MT-D9T-C20	65	100-E26
—	140MT-D9T-C25	65	100-E26

(1) Similar for other contactor configurations (100-E, 104-E, 100S-E, 104S-E)







## Accessory Specifications







Table 51 - Auxiliary Contact Specifications—For 140MT-C... and 140MT-D... Devices

Attribute			Front-mounted Auxiliary Contacts Cat. Nos. 140MT-C-AFA, -AFAR/ -AFAR10M10	Right Side-mounted Auxiliary Contacts Cat. No. 140MT-C-ASA	
Rated Thermal Current $I_{th}$	at 40 °C (104 °F) ambient temperature	[A]	5	10	
	at 60 °C (140 °F) ambient temperature	[A]	4	6	
Back-up Fuses gG, gL		[A]	10	10	
General Use current		[A]	5	10	
Rated insulation voltage $U_i$	IEC	[V]	250	690	
	UL/CSA	[V]	240	600	
Contact rating code designation (UL/CSA)		AC	B300	A600	
		DC	R300	Q600	
Rated Supply Current $I_e$	AC-15	24V	[A]	4	6
		120V	[A]	3	5
		240V	[A]	1.5	3
		415V	[A]	—	2
		690V	[A]	—	1
	DC-13	24V	[A]	1.2	2
		125V	[A]	0.22	0.55
		250V	[A]	0.11	0.27
		400V	[A]	—	0.15
		500V	[A]	—	0.13
Type of Terminals					
Recommended screwdriver			Pozidriv No. 2/Blade No.3	Pozidriv No. 2/Blade No.3	
Flexible with insulated ferrule		1 or 2 conductors	0.5...1.5 mm <sup>2</sup> /No. 18...14 AWG	0.5...2.5 mm <sup>2</sup> /No. 18...14 AWG	
Flexible		1 or 2 conductors	0.5...1.5 mm <sup>2</sup> /No. 18...14 AWG	0.75...2.5 mm <sup>2</sup> /No. 18...14 AWG	
Stranded per UL/CSA		1 or 2 conductors	0.5...1.5 mm <sup>2</sup> /No. 18...14 AWG	0.75...2.5 mm <sup>2</sup> /No. 18...14 AWG	
Solid		1 or 2 conductors	0.5...1.5 mm <sup>2</sup> /No. 18...14 AWG	0.5...2.5 mm <sup>2</sup> /No. 18...14 AWG	
Conductor steps			Max 2 conductor steps allowed	Max 2 conductor steps allowed	
Tightening torque			1...1.2 N•m/8.9...10.6 lb•in	1...1.2 N•m/8.9...10.6 lb•in	



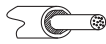

**Table 52 - Auxiliary Contact Specifications—For 140M-F... Devices**

Attribute			Front-mounted Auxiliary Contacts Cat. Nos. 140M-C-AFA..., 140M-C-AFAR...	Right Side-mounted Auxiliary Contacts Cat. Nos. 140M-C-ASA..., 140M-C-ASAR...	
Rated Thermal Current $I_{th}$	at 40 °C (104 °F) ambient temperature	[A]	5	10	
	at 60 °C (140 °F) ambient temperature	[A]	4	6	
Back-up Fuses gG, gL			[A]	10	
Contact rating code designation (UL/CSA)			AC	B300	
			DC	Q300	
Rated Supply Current $I_e$	AC-15	24V	[A]	4	6
		120V	[A]	3	5
		240V	[A]	1.5	3
		415V	[A]	—	2
		690V	[A]	—	0.7
	DC-13	24V	[A]	2	2
		120V	[A]	0.5	0.5
		240V	[A]	0.25	0.25
415V	[A]	—	0.15		
Type of Terminals					
Recommended screwdriver			Pozidriv No. 2/Blade No.3	Pozidriv No. 2/Blade No.3	
Flexible with insulated ferrule 	1 conductor		0.5...1.5 mm <sup>2</sup>	0.5...2.5 mm <sup>2</sup>	
	2 conductors		0.75...1.5 mm <sup>2</sup>	0.75...2.5 mm <sup>2</sup>	
Stranded per UL/CSA 	1 or 2 conductors		0.75...1.5 mm <sup>2</sup> /No. 18...14 AWG	0.75...2.5 mm <sup>2</sup> /No. 18...14 AWG	
Solid 	1 or 2 conductors		0.75...1.5 mm <sup>2</sup> /No. 18...14 AWG	0.75...2.5 mm <sup>2</sup> /No. 18...14 AWG	
Tightening torque			1.2...1.5 N•m/10.6...13 lb•in	1.2...1.5 N•m/10.6...13 lb•in	



**Table 53 - Undervoltage and Shunt Trip Specifications—For 140MT-C... and 140MT-D... Devices**

Attribute				Undervoltage Trip for Left-side Mounting Cat. No. 140MT-C-UX	Shunt Trip for Left-side Mounting Cat. No. 140MT-C-SN	
Actuating Voltage	Pick-up		[V]	$0.85...1.1 \times U_s$	$0.7...1.1 \times U_s$	
	Drop-out		[V]	$0.7...0.35 \times U_s$	$0.7...1.1 \times U_s$	
Rated AC Control Voltage	140MT-C-UXK	50 Hz	[V AC]	24	—	
		60 Hz	[V AC]	28	—	
	140MT-C-UXD	50 Hz	[V AC]	110	—	
		60 Hz	[V AC]	120	—	
	140MT-C-UXF	50 Hz	[V AC]	220...230	—	
		60 Hz	[V AC]	—	—	
	140MT-C-UXA	50 Hz	[V AC]	—	—	
		60 Hz	[V AC]	240...260	—	
	140MT-C-UXN	50 Hz	[V AC]	380...400	—	
		60 Hz	[V AC]	440...460	—	
	140MT-C-UXB	50 Hz	[V AC]	415	—	
		60 Hz	[V AC]	480	—	
	140MT-C-SNK	50 Hz	[V AC]	—	24	
		60 Hz	[V AC]	—	24...28	
	140MT-C-SND	50 Hz	[V AC]	—	110	
		60 Hz	[V AC]	—	120	
	140MT-C-SNF	50 Hz	[V AC]	—	220...230	
		60 Hz	[V AC]	—	—	
	140MT-C-SNA	50 Hz	[V AC]	—	—	
		60 Hz	[V AC]	—	240...260	
	140MT-C-SNT	50 Hz	[V AC]	—	240	
		60 Hz	[V AC]	—	277	
	140MT-C-SNN	50 Hz	[V AC]	—	380...400	
		60 Hz	[V AC]	—	440...460	
	140MT-C-SNB	50 Hz	[V AC]	—	415	
		60 Hz	[V AC]	—	480	
	On-time				Continuous duty	Continuous duty
	Coil consumption	Pick-up	[VA/W]	8.5/8	8.5/8	
		Hold-in	[VA/W]	4/2	4/2	
	Rated DC Control Voltage	140MT-C-SNZJ		[V DC]	—	24
		On-time				Max 5 s
	Coil consumption	Pick-up	[W]		50	
Type of Terminals						
Recommended screwdriver				Pozidriv No. 2/Blade No.3	Pozidriv No. 2/Blade No.3	
Flexible with insulated ferrule		1 or 2 conductors	$0.5...2.5 \text{ mm}^2 / \text{No. } 18...14 \text{ AWG}$	$0.5...2.5 \text{ mm}^2 / \text{No. } 18...14 \text{ AWG}$		
Flexible		1 or 2 conductors	$0.75...2.5 \text{ mm}^2 / \text{No. } 18...14 \text{ AWG}$	$0.75...2.5 \text{ mm}^2 / \text{No. } 18...14 \text{ AWG}$		
Stranded per UL/CSA		1 or 2 conductors	$0.75...2.5 \text{ mm}^2 / \text{No. } 18...14 \text{ AWG}$	$0.75...2.5 \text{ mm}^2 / \text{No. } 18...14 \text{ AWG}$		
Solid		1 or 2 conductors	$0.5...2.5 \text{ mm}^2 / \text{No. } 18...14 \text{ AWG}$	$0.5...2.5 \text{ mm}^2 / \text{No. } 18...14 \text{ AWG}$		
Conductor steps				Max 2 conductor steps allowed	Max 2 conductor steps allowed	
Tightening torque				$1...1.2 \text{ N}\cdot\text{m} / 8.9...10.6 \text{ lb}\cdot\text{in}$	$1...1.2 \text{ N}\cdot\text{m} / 8.9...10.6 \text{ lb}\cdot\text{in}$	

**Table 54 - Undervoltage and Shunt Trip Specifications—For 140M-F... Devices**



Attribute			Undervoltage Trip for Left-side Mounting Cat. No. 140M-C-UX..., -UC...	Shunt Trip for Left-side Mounting Cat. No. 140M-C-SN...
Actuating Voltage	Pick-up	[V]	0.85...1.1 x U <sub>s</sub>	0.7...1.1 x U <sub>s</sub>
	Drop-out	[V]	0.7...0.35 x U <sub>s</sub>	0.7...1.1 x U <sub>s</sub>
Rated AC Control Voltage	Min	50 Hz [V AC]	21	21
		60 Hz [V AC]	24	24
	Max	60 Hz [V AC]	600	600
	On-time		Continuous duty	Continuous duty
	Coil consumption	Pick-up [VA/W]	8.5/8	8.5/8
Hold-in [VA/W]		4/2	4/2	
Type of Terminals				
Recommended screwdriver			Pozidriv No. 2/Blade No.3	Pozidriv No. 2/Blade No.3
Flexible with insulated ferrule 	1 conductor		0.5...2.5 mm <sup>2</sup>	0.5...2.5 mm <sup>2</sup>
	2 conductors		0.75...2.5 mm <sup>2</sup>	0.75...2.5 mm <sup>2</sup>
Stranded per UL/CSA 	1 or 2 conductors		0.75...2.5 mm <sup>2</sup> /No. 18...14 AWG	0.75...2.5 mm <sup>2</sup> /No. 18...14 AWG
Solid 	1 or 2 conductors		0.75...2.5 mm <sup>2</sup> /No. 18...14 AWG	0.75...2.5 mm <sup>2</sup> /No. 18...14 AWG
Tightening torque			1.2...1.5 N•m/10.6...13.3 lb•in	1.2...1.5 N•m/10.6...13.3 lb•in

**Table 55 - Feeder Terminals**

		Compact Busbar Feeder Terminal		Compact Busbar	
		140MT-C-WTEN	140M-F-WTE	140MT-C-W... <sup>(1)</sup>	140M-F-W...
Rated Thermal Current I <sub>th</sub> at 60 °C (140 °F) ambient temperature	[A]	64	120	64	120
Flexible with insulated ferrule 	1 conductor	2.5...25 mm <sup>2</sup> /No. 14...4 AWG	—	—	—
Stranded per UL/CSA 	1 conductor	2.5...25 mm <sup>2</sup> /No. 14...4 AWG	4...50 mm <sup>2</sup> /No. 12...1/0 MCM	—	—
Solid 	1 conductor	2.5...25 mm <sup>2</sup> /No. 14...4 AWG	2.5...50 mm <sup>2</sup> /No. 12...1/0 MCM	—	—
De-isolation (stripping) length	[mm (in)]	14 (0.55)	—	—	—
Tightening torque		3...3.5 N•m/27...31 lb•in	5...6 N•m/45...54 lb•in	—	—

(1) Rated thermal current is 57 A at 70 °C (158 °F) ambient temperature.

**Table 56 - Feeder Blocks for Compact Busbars**

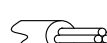
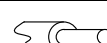
		IEC 60947		UL 60947/CAN/CSA-C22.2 No. 60947			
		140MT-C-WBE 1, 3, 5	140MT-C-WBE 2, 4, 6	140MT-C-WBE L1, L2, L3	140MT-C-WBE T1, T2, T3	140M-F-WBE L1, L2, L3	140M-F-WBE T1, T2, T3
Rated Thermal Current I <sub>th</sub> at 60 °C (140 °F) ambient temperature	[A]	64		64		IEC120/UL115	
Flexible with insulated ferrule 	1 conductor	4...25 mm <sup>2</sup>	for use with 140MT-C-W	No. 10...4 AWG	for use with 140MT-C-W	4...50 mm <sup>2</sup> / No. 10...4 AWG	for use with 140M-F-W
Flexible 	1 conductor	4...25 mm <sup>2</sup>	for use with 140MT-C-W	No. 10...4 AWG	for use with 140MT-C-W	—	—
Stranded per UL/CSA 	1 conductor	4...25 mm <sup>2</sup>	for use with 140MT-C-W	No. 10...4 AWG	for use with 140MT-C-W	4...25 mm <sup>2</sup> / No. 10...4 AWG	for use with 140M-F-W
Solid 	1 conductor	2.5...25 mm <sup>2</sup>	for use with 140MT-C-W	No. 14...4 AWG	for use with 140MT-C-W	2.5...25 mm <sup>2</sup> / No. 14...4 AWG	for use with 140M-F-W
Tightening torque		3...3.5 N•m	2...2.5 N•m	27...31 lb•in	18...22 lb•in	5...6 N•m/45...54 lb•in	

## Time-Current Characteristic

Figure 10 - Motor Protection Circuit Breakers Time-Current Characteristic

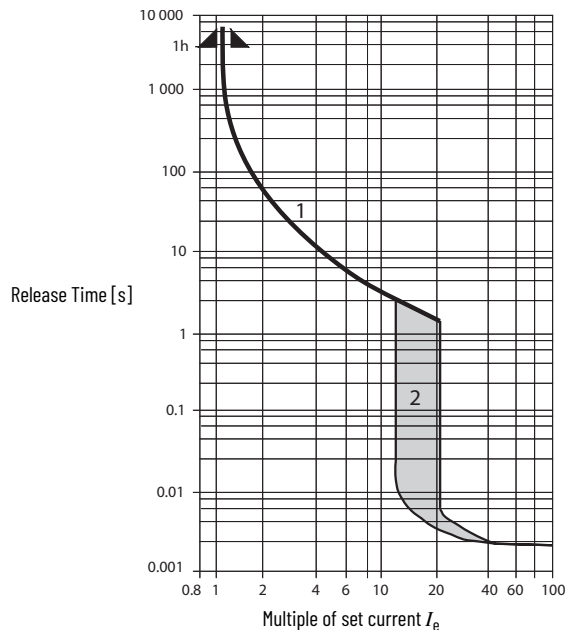

140MT-C, -D, 140M-F Motor Protection Circuit Breakers (for 140MT-D9V, see ratings)

### Thermal Release Trip Current

The adjustable current-dependent delayed bimetal release protects motors against overload. The curve shows the mean operating current at an ambient temperature of 20 °C (68 °F) starting from the cold state. Careful testing and setting ensures effective motor protection even in the case of single phasing. The overload characteristic is also valid for transformer protection.

### Magnetic Release Trip Current

The instantaneous magnetic trip has a fixed operating current setting. This corresponds to 13...14 times the maximum value of the setting range. (Transformer protection up to 20 x  $I_e$  max.) At a lower setting, it is correspondingly higher.

### Current Setting $I_e$ F

The overload trip corresponds to a thermal overload relay in a motor starter conforming to IEC 60947-4-1. If a different value is prescribed (for example, reduced  $I_e$  for cooling medium having a temperature higher than 40 °C (104 °F) or a place of installation higher than 2000 m (6561 ft) above sea level), the setting current is equal to the reduced rated current  $I_e$  of the motor.

# Approximate Dimensions

Dimensions are in millimeters (inches) and are not intended for manufacturing purposes.

## 140MT-C, 140MT-D Devices and Accessories

Figure 11 - Mounting Position

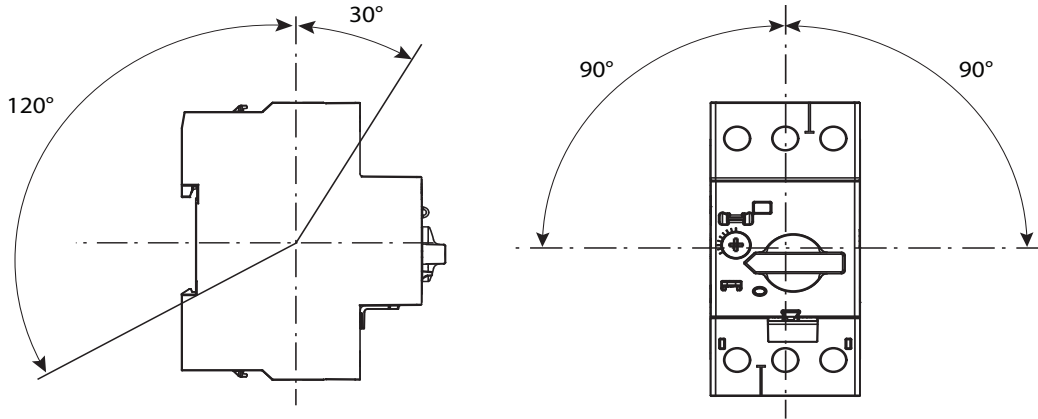
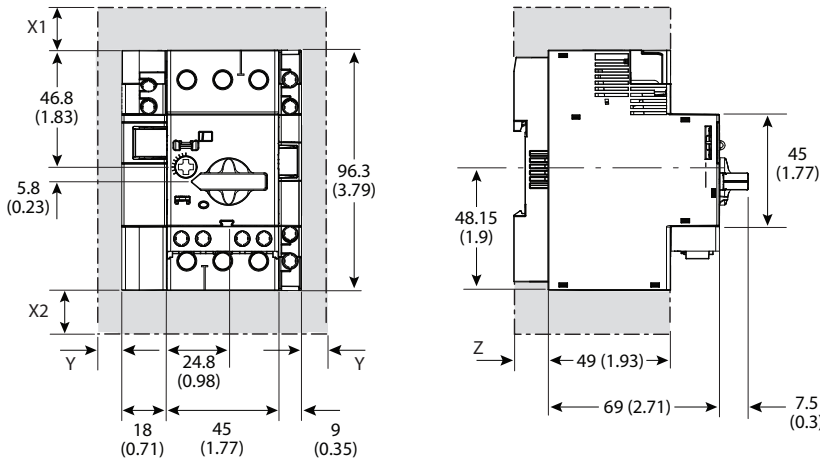
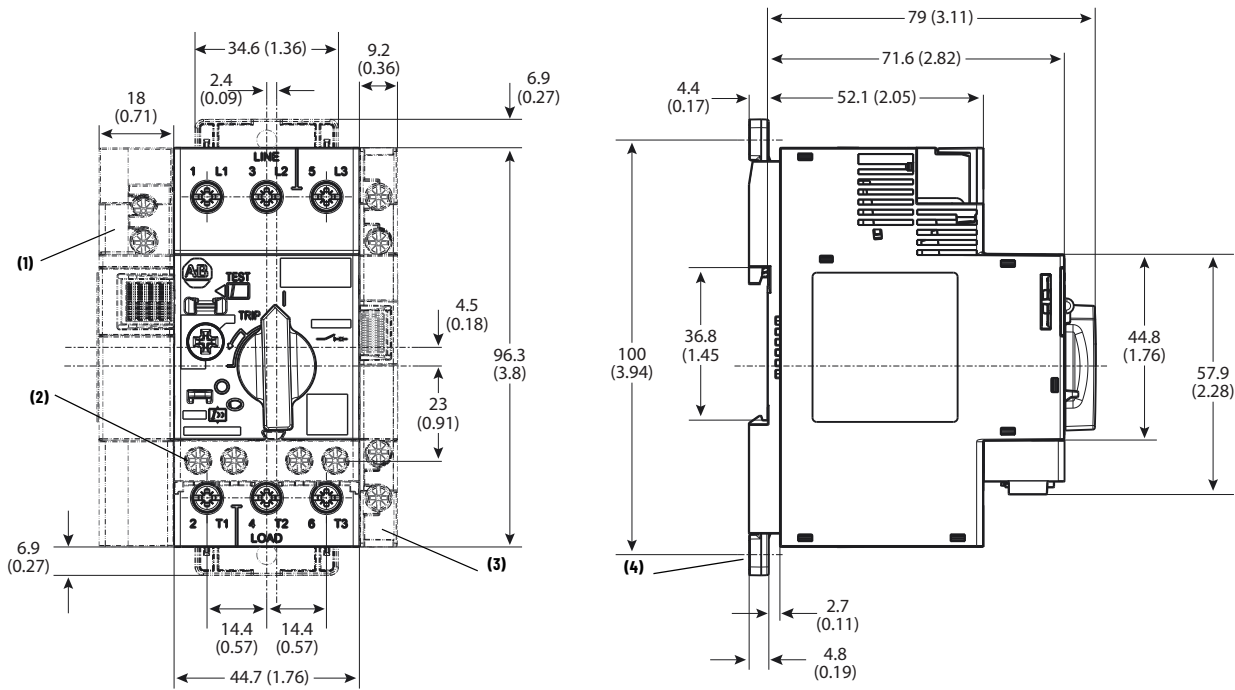

Figure 12 - Spacing Requirements



Frame Size	Voltage [V AC]	Minimum Distance to Grounded Parts or Walls [mm (in)]			Z
		X1	X2	Y	
C-Frame	400	30 (1-3/16)	30 (1-3/16)	9 (23/64)	7.5 (19/64)
	500	30 (1-3/16)	30 (1-3/16)	9 (23/64)	
	690	50 (1-31/32)	50 (1-31/32)	30 (1-3/16)	
D-Frame	400	30 (1-3/16)	30 (1-3/16)	9 (23/64)	13.5 (17/32)
	500	30 (1-3/16)	30 (1-3/16)	9 (23/64)	
	690	50 (1-31/32)	50 (1-31/32)	30 (1-3/16)	

Figure 13 - Motor Protection Circuit Breaker (C-Frame), Cat. No. 140MT-C3...



Note	Information
1	Undervoltage/shunt trip
2	Auxiliary contact (front mounted)

Note	Information
3	Auxiliary contact (side mounted)
4	Screw mounting adapter

Figure 14 - Motor Protection Circuit Breaker (D-Frame), Cat. No. 140MT-D9...

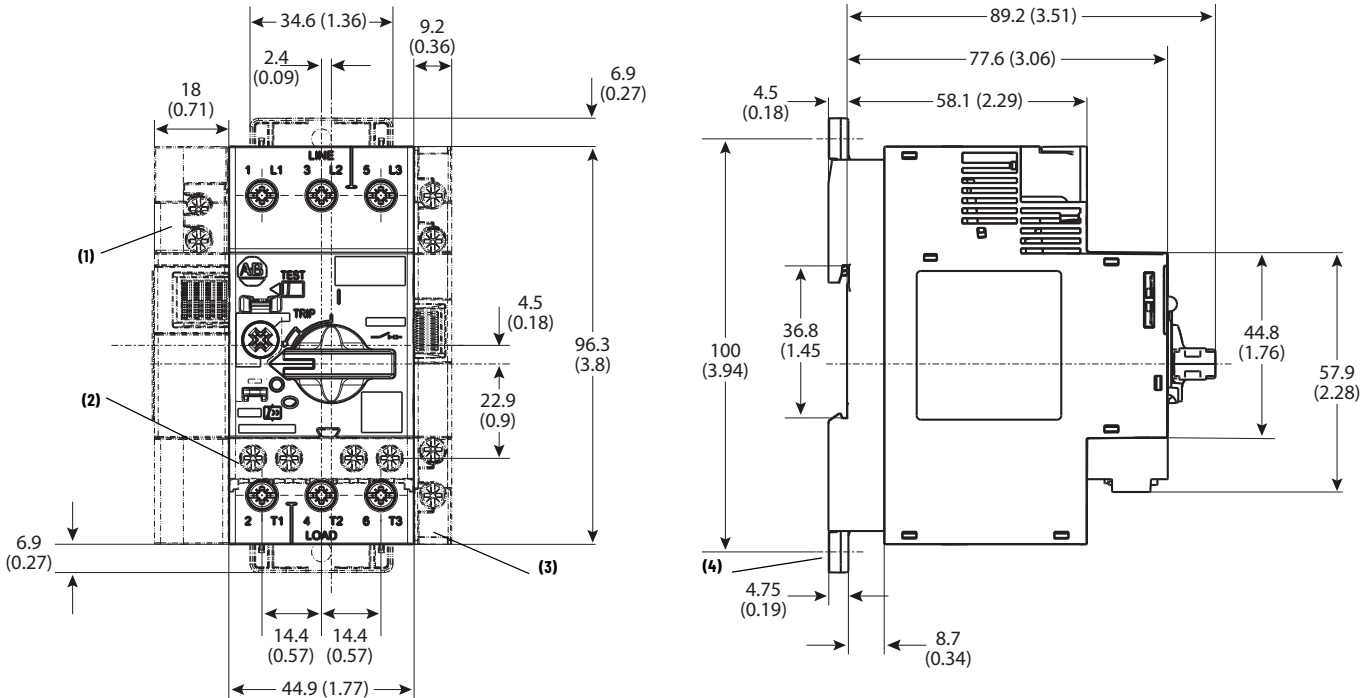

Note	Information
1	Undervoltage/shunt trip
2	Auxiliary contact (front mounted)

Note	Information
3	Auxiliary contact (side mounted)
4	Screw mounting adapter

**Figure 15 - Feeder Terminal for Compact Busbar, Cat. No. 140MT-C-WTEN**

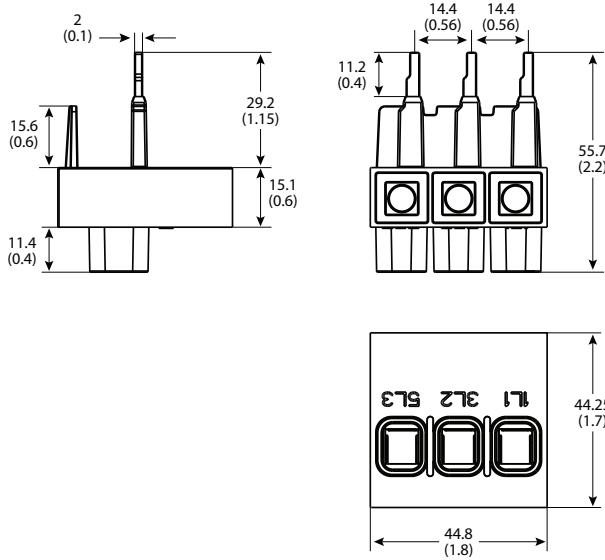

**Figure 16 - Terminal Cover, Cat. No. 140MT-C-WSN**

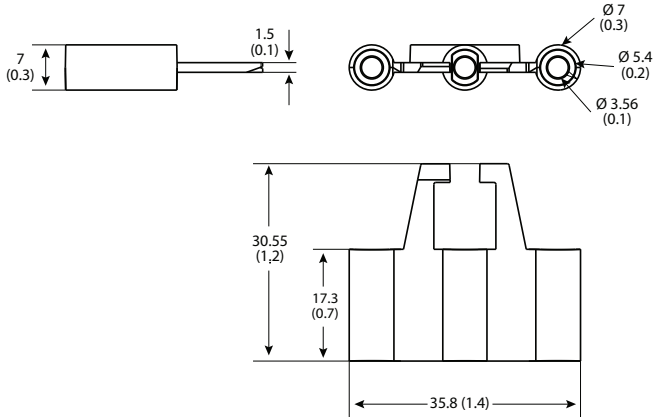

**Figure 17 - 140MT-C and 140MT-D with Cat. No. 140MT-C-TE Type E Adapter**

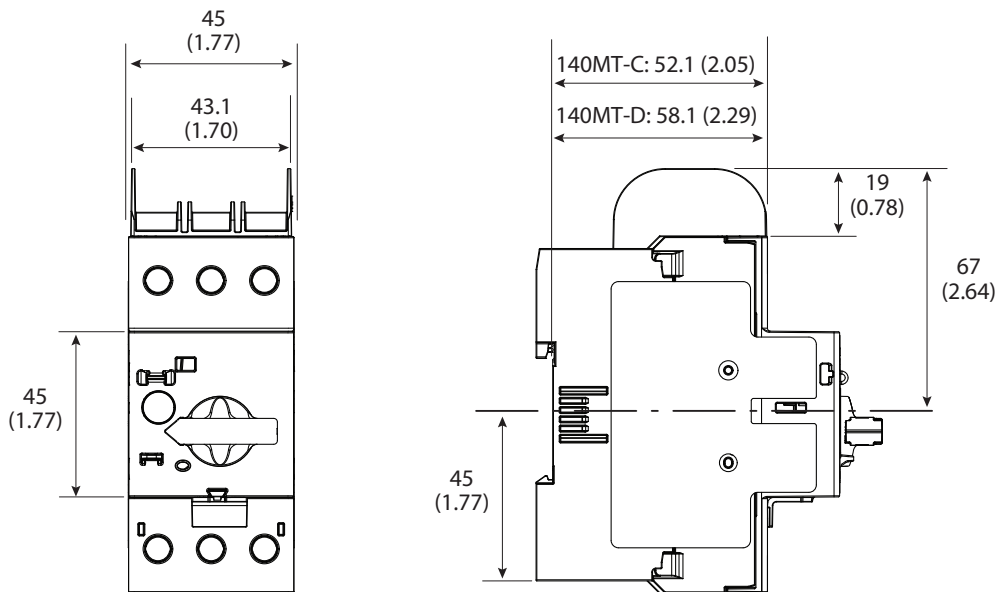



# 140M-F Devices and Accessories

Figure 18 - Mounting Position/Safety Clearance

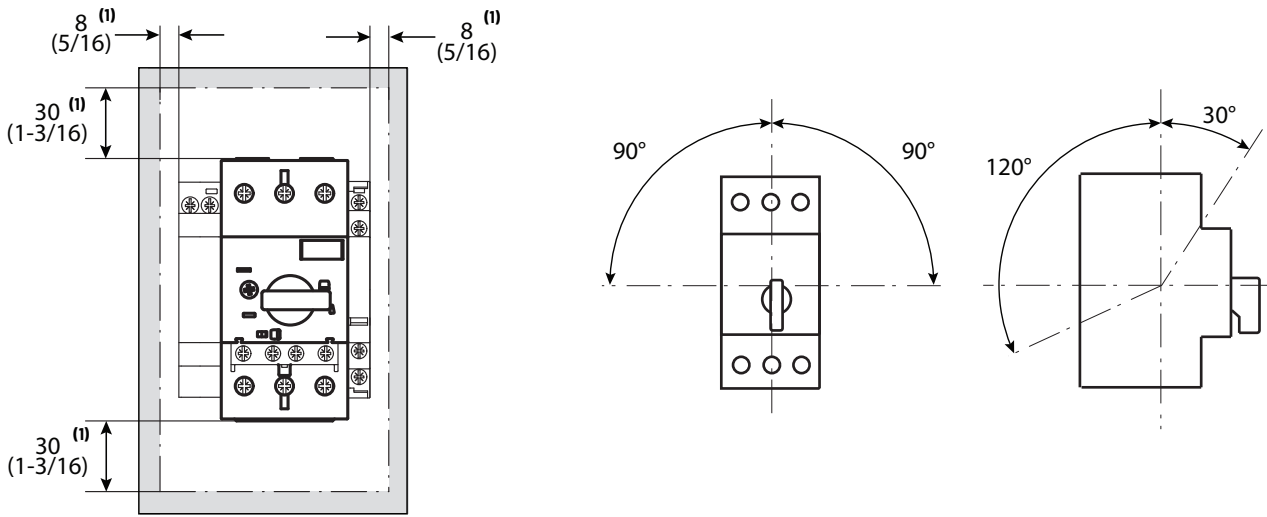

Note	Information
1	Minimum distance to grounded parts or walls

Figure 19 - Motor Protection Circuit Breaker (F-Frame), Cat. No. 140M-F8...

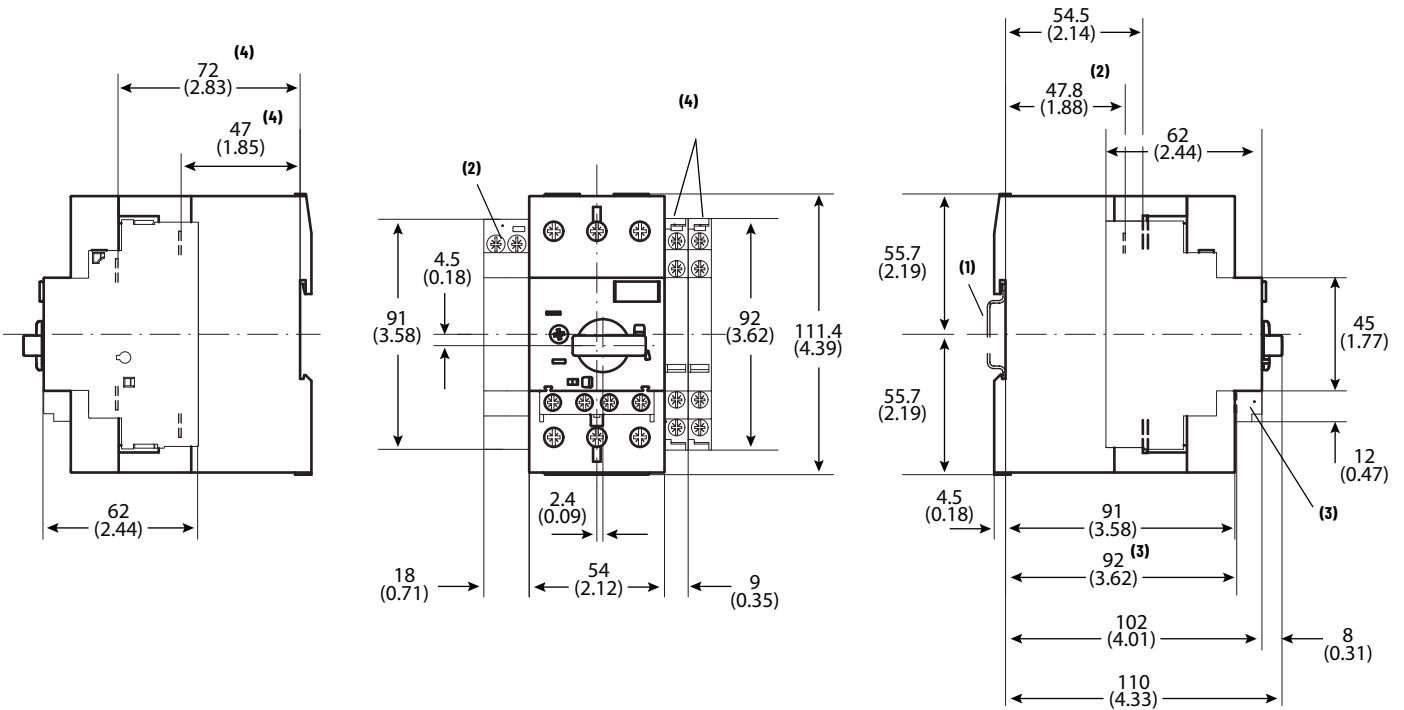

Note	Information
1	Mounting on 35 mm DIN Rail
2	Undervoltage/shunt trip
3	Auxiliary contact (front mounted)
4	Auxiliary contact (side mounted)

Figure 20 - Cat. No. 140M-F-TE Type E adapter on Cat. No. 140M-F8E...

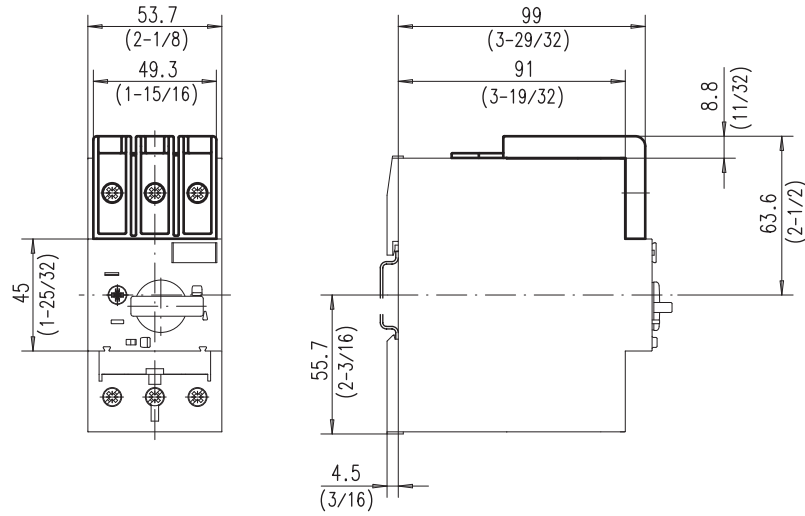
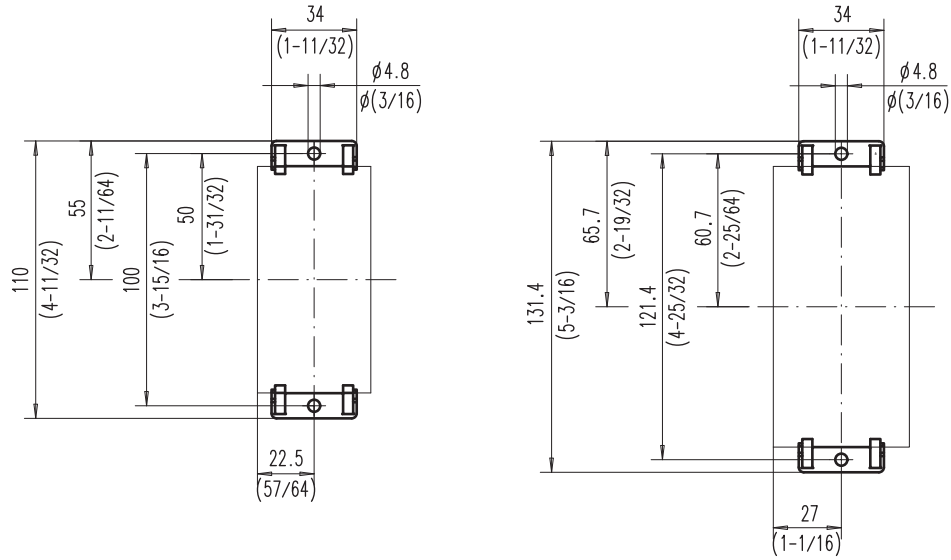

Figure 21 - Screw Adapter, Cat. No. 140M-C-N45



## Additional Resources

These documents contain additional information concerning related products from Rockwell Automation.

Resource	Description
Short-circuit Current Ratings and Your Industrial Control Panel, publication <a href="#">SCCR-AT002</a>	Provides examples for short-circuit current ratings of panels based on the methods stated in UL 508A Supplement B
Rockwell Automation Global SCCR tool, <a href="#">rok.auto/sccr</a>	Provides coordinated high-fault branch circuit solutions for motor starters, soft starters, and component drives.
IEC Contactor Specifications, publication <a href="#">100-TD013</a>	Provides product selection and specification information for IEC contactors.
American Standards, Configurations, and Ratings: Introduction to Motor Circuit Design, publication <a href="#">IC-AT001</a>	Provides an overview of American motor circuit design based on methods that are outlined in the NEC.
ProposalWorks™ configuration software, <a href="#">rok.auto/systemtools</a>	Helps configure complete, valid catalog numbers and build complete quotes based on detailed product information.
Rockwell Automation Global SCCR tool, <a href="#">rok.auto/sccr</a>	Provides coordinated high-fault branch circuit solutions for motor starters, soft starters, and component drives.
UL Standards Listing for Industrial Control Products, publication <a href="#">CMPNTS-SR002</a>	Assists original equipment manufacturers (OEMs) with construction of panels, to help ensure that they conform to the requirements of Underwriters Laboratories.
Industrial Components Preventive Maintenance, Enclosures, and Contact Ratings Specifications, publication <a href="#">IC-TD002</a>	Provides a quick reference tool for Allen-Bradley industrial automation controls and assemblies.
Safety Guidelines for the Application, Installation, and Maintenance of Solid-state Control, publication <a href="#">SGI-1.1</a>	Designed to harmonize with NEMA Standards Publication No. ICS 1.1-1987 and provides general guidelines for the application, installation, and maintenance of solid-state control in the form of individual devices or packaged assemblies incorporating solid-state components.
Industrial Automation Wiring and Grounding Guidelines, publication <a href="#">1770-4.1</a>	Provides general guidelines for installing a Rockwell Automation industrial system.
Product Certifications website, <a href="#">rok.auto/certifications</a>	Provides declarations of conformity, certificates, and other certification details.

You can view or download publications at [rok.auto/literature](#).

# Rockwell Automation Support

Use these resources to access support information.

<b>Technical Support Center</b>	Find help with how-to videos, FAQs, chat, user forums, and product notification updates.	<a href="http://rok.auto/support">rok.auto/support</a>
<b>Knowledgebase</b>	Access Knowledgebase articles.	<a href="http://rok.auto/knowledgebase">rok.auto/knowledgebase</a>
<b>Local Technical Support Phone Numbers</b>	Locate the telephone number for your country.	<a href="http://rok.auto/phonesupport">rok.auto/phonesupport</a>
<b>Literature Library</b>	Find installation instructions, manuals, brochures, and technical data publications.	<a href="http://rok.auto/literature">rok.auto/literature</a>
<b>Product Compatibility and Download Center (PCDC)</b>	Download firmware, associated files (such as AOP, EDS, and DTM), and access product release notes.	<a href="http://rok.auto/pcdc">rok.auto/pcdc</a>

## Documentation Feedback

Your comments help us serve your documentation needs better. If you have any suggestions on how to improve our content, complete the form at [rok.auto/docfeedback](http://rok.auto/docfeedback).





Allen-Bradley, expanding human possibility, ProposalWorks, and Rockwell Automation are trademarks of Rockwell Automation, Inc.

EtherNet/IP is a trademark of ODVA, Inc.

Trademarks not belonging to Rockwell Automation are property of their respective companies.

Rockwell Automation maintains current product environmental compliance information on its website at [rok.auto/pec](http://rok.auto/pec).

Rockwell Otomasyon Ticaret A.Ş. Kar Plaza İş Merkezi E Blok Kat:6 34752, İçerenköy, İstanbul, Tel: +90 (216) 5698400 EEE Yönetmeliğine Uygundur

Connect with us.    

**rockwellautomation.com** ————— expanding **human possibility**<sup>™</sup>

AMERICAS: Rockwell Automation, 1201 South Second Street, Milwaukee, WI 53204-2496 USA, Tel: (1) 414.382.2000, Fax: (1) 414.382.4444

EUROPE/MIDDLE EAST/AFRICA: Rockwell Automation NV, Pegasus Park, De Kleetlaan 12a, 1831 Diegem, Belgium, Tel: (32) 2 663 0600, Fax: (32) 2 663 0640

ASIA PACIFIC: Rockwell Automation, Level 14, Core F, Cyberport 3, 100 Cyberport Road, Hong Kong, Tel: (852) 2887 4788, Fax: (852) 2508 1846

Publication 140-TD005C-EN-P - April 2022

Supersedes Publication 140-TD005B-EN-P - September 2021

Copyright © 2022 Rockwell Automation, Inc. All rights reserved. Printed in the U.S.A.