

FS6IC-AT

6" INC Fire Shield IC/Non-IC Housing 1 or 2 Hour Fire Rated Luminaire

LAMP WATTAGE: (1) MAXIMUM 75W R/PAR30, 60W A19, 65W BR30

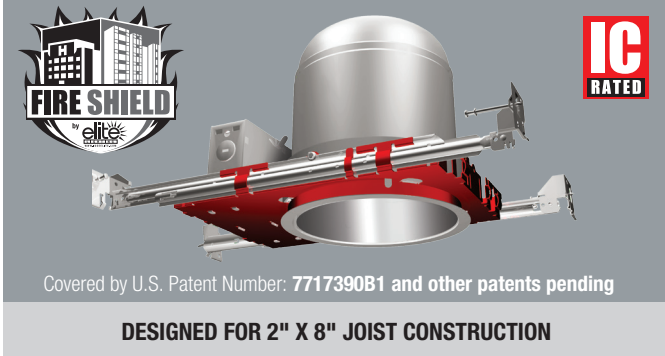

Catalog Number:	
Project Name:	Type:
Note:	FIRE SHIELD

INCANDESCENT LIGHTING FIXTURE CONFORMS TO ASTM STD 119

1-HOUR FIRE RATED Fire rated floor/ceiling assembly refer to UL Design No. L500 & P500	2-HOUR FIRE RATED Fire rated floor/ceiling assembly refer to UL Design No. L505
FOR MORE INFORMATION, PLEASE REFER TO THE INSTRUCTION MANUAL	

Our FIRE SHIELD Housing Is Designed To Meet Today's **One or Two-Hour Fire-Rated IC & Non-IC Codes for high-rise Condominiums, Apartment Buildings, Multi-Family Residences, Hotels, Hospitality, Assisted Living Homes, Hospitals, Health Care and many more applications.** Accommodates up to 75W PAR30/R30 lamps, 60W A19 lamps and 65W BR30 lamps. Furnished with preinstalled adjustable bar hangers. Junction box is provided with four 1/2" KOs, one 3/4" KO and four Romex knockouts with strain relief.

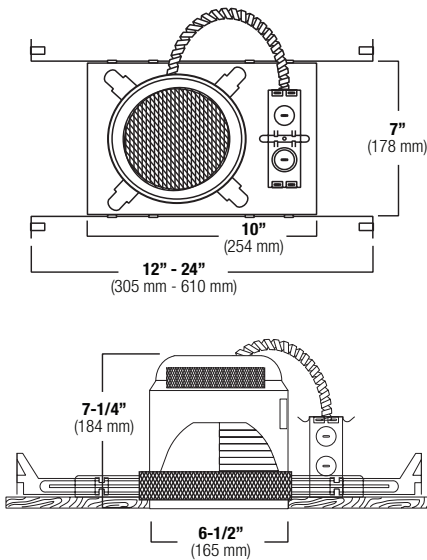

FIRE PROTECTION PERFORMANCE

- The luminaire ships assembled with the fire protection material already attached in their working positions
- As the fire intensifies, a protection disk seals off the bottom opening of the housing and stops the fire from passing through the fixture
- The inner assembly reacts strongly to high temperatures (428°F/220°C and above) and swells to a solid dense mass filling the entire luminaire cavity
- Prevents flames and smoke from passing through the light fixture and spreading throughout floor above
- Fire Shield recessed lighting luminaire eliminates the use of subcontractors to build additional boxes around a luminaire to achieve a 1-hour or 2-hour fire rating
- The Fire Shield family of Lighting Luminaires protect the floors above by preventing heat and flames from passing into the ceiling void
- Easier and faster to install than custom-built fireboxes and housings that require hats or additional fire-rated materials

B. SOCKET - Medium base screw shell porcelain socket preinstalled on adjustable mounting bracket is designed to allow usage of different lamp types, as well as proper and consistent lamp positioning.

C. THERMAL PROTECTION - Standard thermal protection device guards against improper installation, overlamping and misuse of insulation material.

D. BAR HANGERS - Preinstalled bar hangers allow housing to be positioned and locked at any point within a 24" joist span. They can be positioned on either the long or short axis of the housing and can be shortened for 12" joists. They contain a double-headed real nail for 20° downward angle for better contact, and the 90° pivoting mounting plate makes installation fast and accurate.

E. JUNCTION BOX - ETL listed for through-branch circuit wiring and has four 1/2" KOs, one 3/4" KO and four Romex knockouts with true pry-out slots and strain clamps.

SPECIFICATION

A. HOUSING - High temperature painted 22 gauge cold-rolled steel construction for maximum heat dissipation and rust protection. Factory assembled with 1 or 2 hour Fire-rated components. Adjusts vertically in plaster frame to accommodate 1/2" to 1 -3/4" ceiling. This includes ceiling constructions of all 1 hour and 2 hour fire-rated assemblies

AIR-SHUT ASTM E283

- Gasket to prevent air flow from heated or air conditioned spaces.
- Meets all national air flow requirements.



ITEM SELECTOR: (Please check the boxes below for the option desired)

TYPE	TRIM TYPE	BAFFLE ¹	REFLECTOR ²	TRIM/RING ³	
FS6IC-AT-W	<input type="checkbox"/> AF640 - 6" Deep Self-Flange Air-Shut Matte Finish Baffle ^{1,3}	<input type="checkbox"/> W	<input type="checkbox"/> CL	<input type="checkbox"/> WH	
	<input type="checkbox"/> AF632 - 6" Air-Shut Reflector ^{2,3}	<input type="checkbox"/> P	<input type="checkbox"/> RG	<input type="checkbox"/> BK	
	<input type="checkbox"/> AF601 - 6" Metal Albalite Shower Trims ³	<input type="checkbox"/> SN	<input type="checkbox"/> W	<input type="checkbox"/> SN	
	<input type="checkbox"/> AF605 - 6" Metal Fresnel Shower Trims ³	<input type="checkbox"/> CP	<input type="checkbox"/> MB	<input type="checkbox"/> CP	
	<input type="checkbox"/> AF606 - 6" Metal Drop Opal Shower Trims ³	<input type="checkbox"/> BZ	<input type="checkbox"/> BZ	<input type="checkbox"/> CH	
	<input type="checkbox"/> AF601L - 6" Polycarbonate Albalite Shower Trims		<input type="checkbox"/> CP	<input type="checkbox"/> PB	
	<input type="checkbox"/> AF605L - 6" Polycarbonate Fresnel Shower Trims		<input type="checkbox"/> SN	<input type="checkbox"/> BZ	
	<input type="checkbox"/> AF606L - 6" Polycarbonate Drop Opal Shower Trims		<input type="checkbox"/> SHZ		
	<input type="checkbox"/> AF635 - 6" Baffle w/ Albalite Lens ^{1,3}	<input type="checkbox"/> AF635 - 6" Baffle w/ Albalite Lens ^{1,3}			
	<input type="checkbox"/> AF636 - 6" Baffle w/ Fresnel Lens ^{1,3}	<input type="checkbox"/> AF636 - 6" Baffle w/ Fresnel Lens ^{1,3}			
<input type="checkbox"/> AF641 - 6" Reflector w/ Albalite Lens ^{2,3}	<input type="checkbox"/> AF641 - 6" Reflector w/ Albalite Lens ^{2,3}				
<input type="checkbox"/> AF642 - 6" Reflector w/ Fresnel Lens ^{2,3}	<input type="checkbox"/> AF642 - 6" Reflector w/ Fresnel Lens ^{2,3}				
<input type="checkbox"/> B602 - 6" Eyeball ³	<input type="checkbox"/> B602 - 6" Eyeball ³				
<input type="checkbox"/> AF633 - 6" R/PAR30 Open Trim ³	<input type="checkbox"/> AF633 - 6" R/PAR30 Open Trim ³				

Specifications:

FS6IC-AT-W - _____ - _____ - _____ - _____
 TRIM TYPE BAFFLE REFLECTOR TRIM/RING

BAFFLE ¹	REFLECTOR ²	TRIM/RING ³
W White	CL Chrome	WH White
P Black	RG Gold	BK Black
SN Satin Nickel	W White	SN Satin Nickel
CP Copper	MB Black	CP Copper
BZ Bronze	BZ Bronze	CH Chrome
	CP Copper	PB Polish Brass
	SN Satin Nickel	BZ Bronze
	SHZ Satin Haze	

Sample of Catalog Number: FS6IC-AT-W-AF637-W-WH

*For custom baffle, reflector, trim ring, glass color and lens options, please consult factory.



Submittal form is available @ www.fireshieldlighting.com
 Tel: 323-888-1973 • Fax: 323-888-1977

Specifications and Dimensions subject to change without notice.

6" Incandescent Trims

(LAMP WATTAGE: (1) MAXIMUM 75W R/PAR30, 60W A19, 65W BR30)

Catalog Number:

Project Name:

Type:

Note:

FIRE SHIELD

AF640W-WH Deep Self Flange
Air-Shut Matte Finish Baffle



NEW
CLIP
DESIGN

AVAILABLE COLOR
COMBINATIONS:
CP-CP, SN-SN, W-WH,
P-WH, P-BK, BZ-BZ

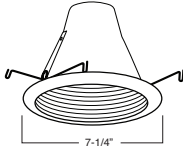

(LAMP WATTAGE: 75W)

AF632CL-WH
Air-Shut Reflector



NEW
CLIP
DESIGN

AVAILABLE COLOR
COMBINATIONS:
CL-WH, CL-CH, RG-WH,
RG-PB, W-WH, MB-WH,
CP-CP, MB-BK, SN-SN,
SN-WH

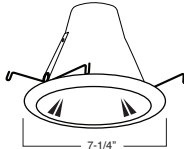

(LAMP WATTAGE: 75W)

AF601SN
Metal Albalite Shower Trims



FOR
WET
LOCATION

TRIM:
WH, BK, SN, CP,
CH, PB, BZ

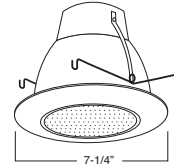

(LAMP WATTAGE: 40W-A19)

AF601L Non-Conducting Polycarbonate
Front Loading Albalite Shower Trim



FOR
WET
LOCATION

AVAILABLE TRIM
COLOR:
WH

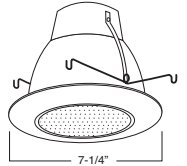

(LAMP WATTAGE: 40W-A19)

AF605CH
Metal Fresnel Shower Trims



FOR
WET
LOCATION

TRIM:
WH, BK, SN, CP,
CH, PB, BZ

(LAMP WATTAGE:
40W-A19)

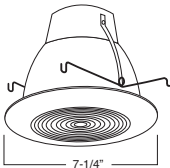

AF606SN
Metal Drop Opal Shower Trims



FOR
WET
LOCATION

TRIM:
WH, BK, SN, CP,
CH, PB, BZ

(LAMP WATTAGE:
40W-A19)

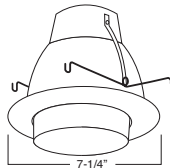

AF635P-WH
Baffle with Albalite Lens



FOR
WET
LOCATION

BAFFLE:
W, P, SN, CP, BZ

TRIM:
WH, BK, SN, CP, CH,
PB, BZ

(LAMP WATTAGE: 40W-A19)

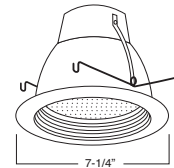

AF636W-WH
Baffle with Fresnel Lens



FOR
WET
LOCATION

BAFFLE:
W, P, SN, CP, BZ

TRIM:
WH, BK, SN, CP,
CH, PB, BZ

(LAMP WATTAGE: 40W-A19)

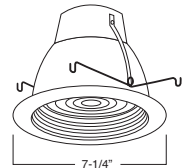

AF641RG-WH
Reflector with Albalite Lens



FOR
WET
LOCATION

REFLECTOR:
CL, RG, W, MB, CP,
SN, SHZ

TRIM:
WH, BK, SN, CP, CH,
PB, BZ

(LAMP WATTAGE: 40W-A19)

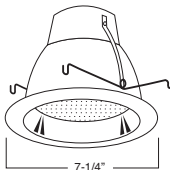

AF642CL-WH
Reflector w/ Fresnel Lens



FOR
WET
LOCATION

REFLECTOR:
CL, RG, W, MB, CP,
SN, SHZ

TRIM:
WH, BK, SN, CP, CH,
PB, BZ

(LAMP WATTAGE: 40W-A19)

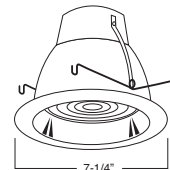

B602SN
Eyeball



TRIM:
WH, BK, SN, CP, CH,
PB, BZ

(LAMP WATTAGE: 75W)

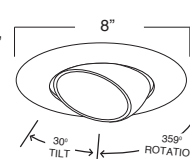

AF633WH
R/PAR30 Open Trim

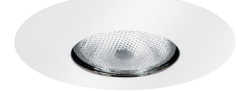

TRIM:
WH, BK, SN, CP, CH,
PB, BZ

(LAMP WATTAGE: 75W)

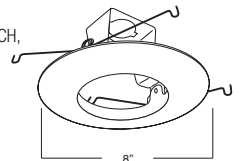

Trim Color Options



W-WH
White White



P-BK
Black Black



BZ-BZ
Bronze Bronze



CP-CP
Copper Copper



SN-SN
Satin Nickel



CL-WH
Clear White



CL-CH
Clear Chrome



SN-SN
Satin Nickel



W-WH
White White



SN-WH
Satin White



MB-WH
Black White



RG-WH
Gold White



RG-PB
Gold Polish Brass



BZ-BZ
Bronze Bronze



CP-CP
Copper Copper



MB-BK
Black Black

PATENT PENDING

FIRE SHIELD

Submittal form is available @ www.fireshieldlighting.com
Tel: 323-888-1973 • Fax: 323-888-1977

Specifications and Dimensions
subject to change without notice.