

B25IC-AT

5" Shallow IC Housing

LAMP WATTAGE: (1) MAXIMUM 50W R/PAR30, 40W A19

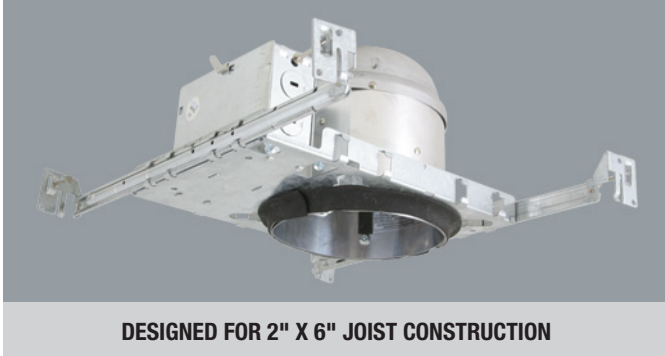

DESIGNED FOR 2" X 6" JOIST CONSTRUCTION

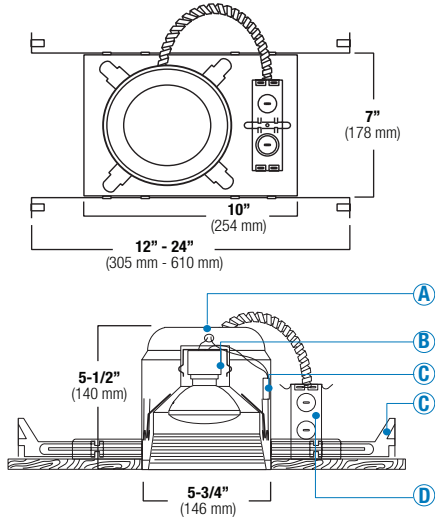

ITEM SELECTOR: (Please check the boxes below for the option desired)

TYPE	AIR-SHUT	OPTION	TRIM TYPE	BAFFLE	REFLECTOR	TRIM/RING
B25IC	<input type="checkbox"/> AT	<input type="checkbox"/> (W) With quick connects	<input type="checkbox"/> B531 <input type="checkbox"/> B508 <input type="checkbox"/> B563 <input type="checkbox"/> B502 <input type="checkbox"/> B514	<input type="checkbox"/> W <input type="checkbox"/> P <input type="checkbox"/> SN <input type="checkbox"/> CP <input type="checkbox"/> BZ	<input type="checkbox"/> CL <input type="checkbox"/> RG <input type="checkbox"/> W <input type="checkbox"/> MB <input type="checkbox"/> BZ <input type="checkbox"/> CP <input type="checkbox"/> SN <input type="checkbox"/> SHZ	<input type="checkbox"/> WH <input type="checkbox"/> BK <input type="checkbox"/> SN <input type="checkbox"/> CP <input type="checkbox"/> CH <input type="checkbox"/> PB <input type="checkbox"/> BZ

Specifications:

B25IC AIR-SHUT OPTION TRIM TYPE BAFFLE REFLECTOR TRIM/RING

BAFFLE	REFLECTOR	TRIM/RING
W White	CL Chrome	WH White
P Black	RG Gold	BK Black
SN Satin Nickel	W White	SN Satin Nickel
CP Copper	MB Black	CP Copper
BZ Bronze	BZ Bronze	CH Chrome
	CP Copper	PB Polish Brass
	SN Satin Nickel	BZ Bronze
	SHZ Satin Haze	

Sample of Catalog Number: B25IC-AT-W-B531-W-WH

*For custom baffle, reflector, trim ring, glass color and lens options, please consult factory.



Submittal form is available @ www.iuseelite.com
Tel: 323-888-1973 • Fax: 323-888-1977

Specifications and Dimensions
subject to change without notice.

REV: ELITE LIGHTING-SPEC-06-29-2011

Catalog Number:

Project Name:

Type:

Note:



DESCRIPTION

For new construction. Thermally protected, IC rated specification grade recessed housing. Accommodates up to 50W PAR30, R30 lamps and 40W A19 lamps. Furnished with preinstalled adjustable bar hangers. Junction box is provided with four 1/2" KOs, one 3/4" KO and four Romex knockouts with strain relief.

SPECIFICATION

A. HOUSING - Die-formed all aluminum construction for maximum heat dissipation and rust protection. Adjusts vertically in plaster frame to accommodate 1/2" to 1-3/8" ceiling.

B. SOCKET - Medium base screw shell porcelain socket snaps into trim to allow usage of different lamp types, as well as proper and consistent lamp positioning.

C. BAR HANGERS - Preinstalled bar hangers allow housing to be positioned and locked at any point within a 24" joist span. They can be positioned on either the long or short axis of the housing and can be shortened for 12" joists. They contain a double-headed real nail for 20° downward angle for better contact, and the 90° pivoting mounting plate makes installation fast and accurate. Bar hangers can fit onto T-Bar spline with additional slots and holes for special mounting methods if necessary.

D. JUNCTION BOX - ETL listed for through-branch circuit wiring and has four 1/2" KOs, one 3/4" KO and four Romex knockouts with true pry-out slots and strain clamps.

E. THERMAL PROTECTION - Standard thermal protection device guards against improper installation, overlampping and misuse of insulation material.

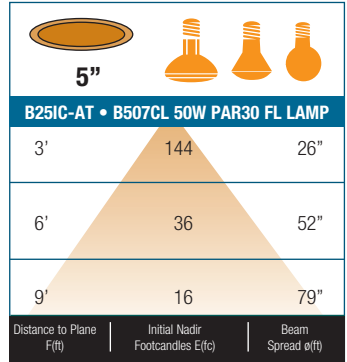

BEAM DIA. MEASURED AT 50% OF NADIR F.C.

FEATURES

- Thermally Protected IC housing.
- Wire through junction box.
- Preinstalled adjustable bar hanger.
- Dependable, favorable design and effortless installation.
- 5 1/2" height allows use in 2" x 6" joist construction.
- Special screw on the frame locks bar hangers in place which prevents the housing from any movement once installed.
- Preinstalled socket cap provides electrical contact protection against dust, paint and over spray.

OPTIONS

AIR-SHUT

- Gasket to prevent air flow from heated or air conditioned spaces.
- Meets all national air flow requirements.

5" Incandescent Trims

(LAMP WATTAGE: 50W R/PAR30, 40W A19)

Catalog Number:

Project Name:

Type:

Note:



B531CP-CP SHALLOW STEPPED BAFFLE



AVAILABLE COLOR COMBINATIONS:
CP-CP, SN-SN, W-WH, P-WH, P-BK, BZ-BZ

TO BE USED WITH B25IC-AT & B25RIC-AT HOUSING ONLY

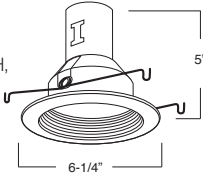

B508RG-WH SHALLOW REFLECTOR



AVAILABLE COLOR COMBINATIONS:
CP-CP, W-WH, RG-WH, MB-WH, CL-WH, MB-BK, RG-PB, CL-CH

TO BE USED WITH B25IC-AT & B25RIC-AT HOUSING ONLY

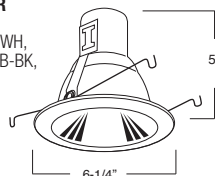

B563PB PAR30 GIMBAL TRIM

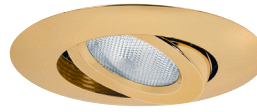

TRIM/RING FINISH:
WH, BK, SN, CP, CH, PB, BZ

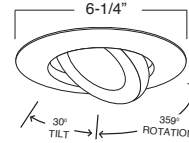

B502SN EYEBALL



TRIM/RING FINISH:
WH, BK, SN, CP, CH, PB, BZ

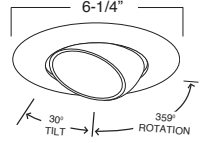

B514WH SHOWER TRIM



FOR
WET
LOCATION

TRIM/RING FINISH:
WH

TO BE USED WITH B25IC-AT & B25RIC-AT HOUSING ONLY

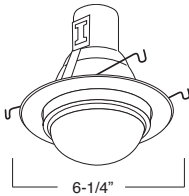

BAFFLE	REFLECTOR	TRIM RING
W White	CL Chrome	WH White
P Black	RG Gold	BK Black
SN Satin Nickel	W White	SN Satin Nickel
CP Copper	MB Black	CP Copper
BZ Bronze	CP Copper	CH Chrome
	SN Satin Nickel	PB Polish Brass
		BZ Bronze

*For custom baffle, reflector, trim ring, glass color and lens options, please consult factory.