

SIDES	BOTTOM
Material: Steel-0.059"-C.R.S , Powder coating gary	
Gasket Material: PVC Closed-cell foam	

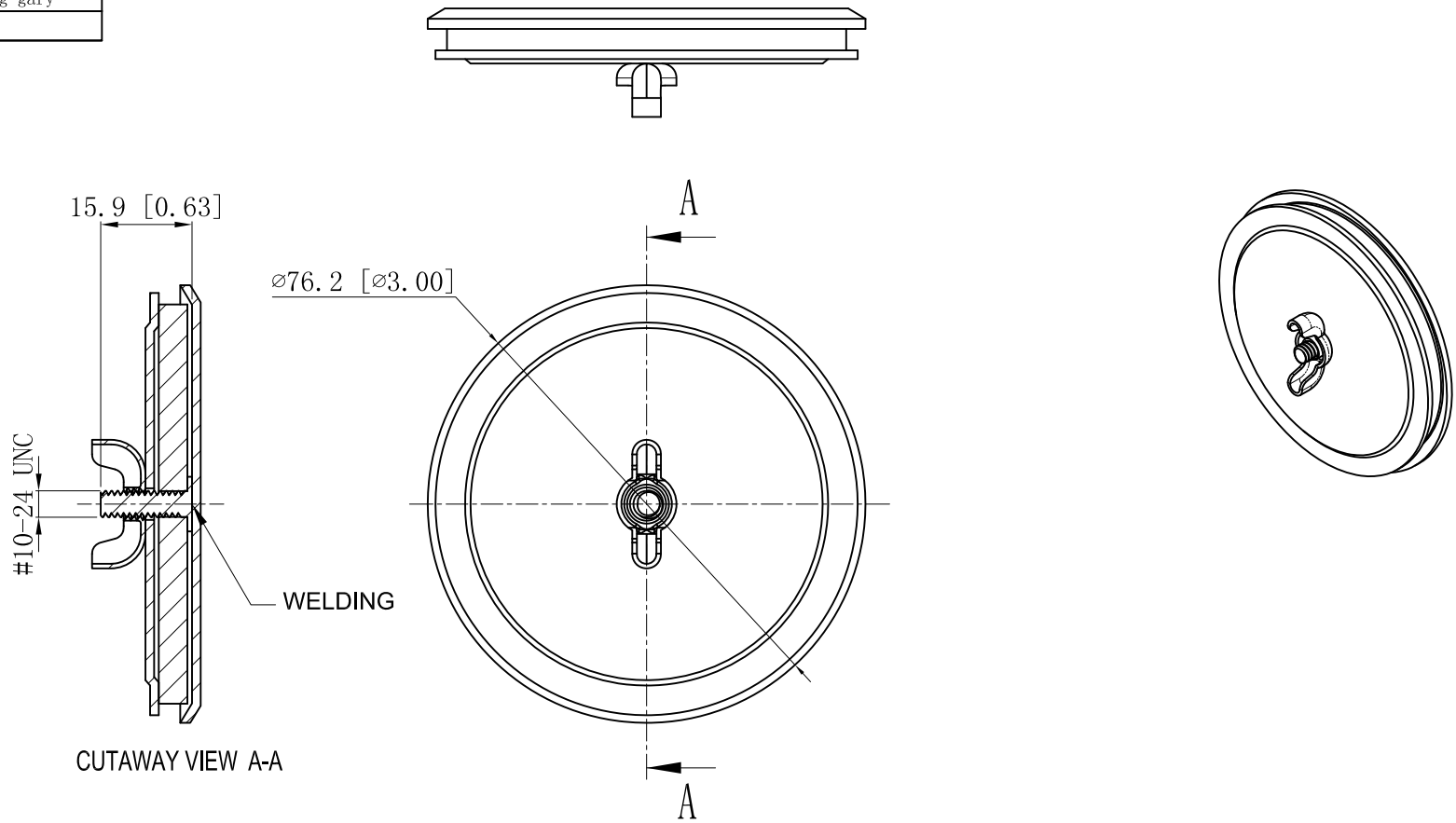

This data sheet is for reference only .GARVIN INDUSTRIES reserves the right to make changes to the design without prior notice.

DESCRIPTION
TRADE REFERENCE TERMS

STANDARD PACKING	<h1 style="text-align: center;">GARVIN INDUSTRIES</h1>		
5 PCS			
TITLE	KNOCKOUT SEALS		
SIZE	DWG NO.		REV
A4		KOS-200-OT	B
DATA SHEET			
www.garvinindustries.com			