Device Boxes

Armoured and nonmetallic sheathed cable clamps

Iberville LHTQ™ Family

Presenting the LHTQ family of Iberville boxes. With their additional cubic capacity, this family of boxes is designed for any installations that require a greater number of conductors such as heating, GFCI and arc-fault applications.

What's more, because it's an LHTQ, installation is always fast and accurate. Look for these practical and time saving features on all LHTQ models.

Features and benefits

- Positioning guides for drywall and outside wall applications
- Retractable positioning tabs
- Internally embossed mounting slots
- Flat box sides for maximum stability
- Holding prongs
- Single and 2 gang boxes are CSA approved for one-screw mounting



Device boxes

Armoured and nonmetallic sheathed cable clamps



01



02



03



04



05



06

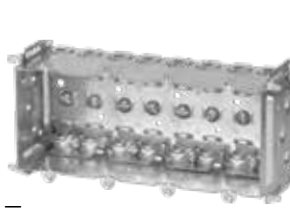

07



08

01 BC1018-LHTQ

Internally embossed slots for screw mounting. Fixed positioning tabs for single $\frac{1}{2}$ in. drywall along with retractable positioning tabs for double $\frac{1}{2}$ in. drywall applications. Fixed positioning tabs for outside wall applications. Holding prongs. One screw mounting.

02 BC1304-LHTQ

Internally embossed slots for screw mounting. Fixed positioning tabs for single $\frac{1}{2}$ in. drywall along with retractable positioning tabs for double $\frac{1}{2}$ in. drywall applications. Fixed positioning tabs for outside wall applications. Holding prongs. One screw mounting.

03 BC2004-LHTQ

Internally embossed slots for screw mounting. Fixed positioning tabs for single $\frac{1}{2}$ in. drywall along with retractable positioning tabs for double $\frac{1}{2}$ in. drywall applications. Fixed positioning tabs for outside wall applications. Holding prongs. One screw mounting.

04 BC2304-LHTQ

Internally embossed slots for screw mounting. Fixed positioning tabs for single $\frac{1}{2}$ in. drywall along with retractable positioning tabs for double $\frac{1}{2}$ in. drywall applications. Fixed positioning tabs for outside wall applications. Holding prongs. One screw mounting.

05 BC2304-LHTQ-2

Internally embossed slots for screw mounting. Fixed positioning tabs for single $\frac{1}{2}$ in. drywall along with retractable positioning tabs for double $\frac{1}{2}$ in. drywall applications. Fixed positioning tabs for outside wall applications. Holding prongs. One screw mounting.

06 BC2304-LHTQ-3

Internally embossed slots for screw mounting. Fixed positioning tabs for single $\frac{1}{2}$ in. drywall along with retractable positioning tabs for double $\frac{1}{2}$ in. drywall applications. Fixed positioning tabs for outside wall applications. Holding prongs.

07 BC2304-LHTQ-4

Internally embossed slots for screw mounting. Fixed positioning tabs for single $\frac{1}{2}$ in. drywall along with retractable positioning tabs for double $\frac{1}{2}$ in. drywall applications. Fixed positioning tabs for outside wall applications. Holding prongs.

08 BC3104-LHTQ

Internally embossed slots for screw mounting. Fixed positioning tabs for single $\frac{1}{2}$ in. drywall along with retractable positioning tabs for double $\frac{1}{2}$ in. drywall applications. Fixed positioning tabs for outside wall applications. Holding prongs.

Cat. No.	Dimensions H x W x D (in.)	Volume (Cu. in.)	Gangable Yes or No	Features			Pryouts ends
				One screw mounting	Pos. tabs	Prov. for external nailing	
BC1018-LHTQ	3 x 2 x 3	18.0	yes	yes	yes	yes	4
BC1304-LHTQ	3 x 2 x 2 $\frac{1}{2}$	14.5	yes	yes	yes	yes	4
BC1304-LHATQ	3 x 2 x 2 $\frac{1}{2}$	14.5	yes	yes	yes	yes	4
BC2004-LHTQ	3 $\frac{3}{4}$ x 2 $\frac{3}{16}$ x 2 $\frac{3}{4}$	20.5	no	yes	yes	yes	4
BC2304-LHTQ	3 x 2 x 2 $\frac{1}{2}$	14.5	no	yes	yes	yes	4
BC2304-LHTQ-2	3 x 3 $\frac{3}{4}$ x 2 $\frac{1}{2}$	27.0	no	yes	yes	yes	8
BC2304-LHTQ-3	3 x 5 $\frac{1}{2}$ x 2 $\frac{1}{2}$	39.5	no	no	yes	yes	12
BC2304-LHTQ-4	3 x 7 $\frac{3}{8}$ x 2 $\frac{1}{2}$	52.0	no	no	yes	yes	16
BC3104-LHTQ	3 x 2 x 2 $\frac{1}{2}$	16.0	yes	yes	yes	yes	4

Device boxes

Conduit knockouts

—
01 CI425
 “Screwlok” brackets
 for rework installation.
 Max. wall thickness:
 $\frac{5}{8}$ in.



—
01

—
02 BC1102
 Recessed ears

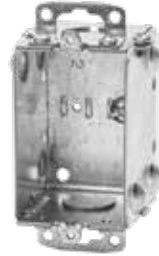

—
02

—
03 CI1102-SB

—
04 CI3102-SSX
 “Wraparound” bracket
 for $1\frac{5}{8}$ in. steel studs.
 With integral
 support bracket.



—
03

—
05 BC1104
 Recessed ears

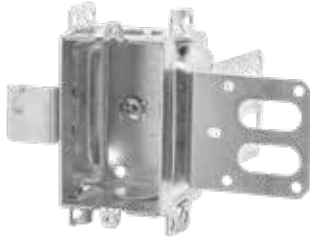

—
04

—
06 CI1104-B



—
05



—
06



Cat. No.	Volume (Cu. in.)	Features			Knockouts	
		Ears	Bracket	$\frac{1}{2}$ in. ends	$\frac{1}{2}$ in. bottom	
2 in. deep – gangable – 3 in. x 2 in						
CI425	10.0	flush	rework	2	–	
BC1102	10.0	recessed	–	2	–	
CI1102-SB	10.0	–	“SB”	2	–	
CI3102-SSX	12.0	–	“SSX”	2	–	
2 1/2 in. deep – gangable – 3 in. x 2 in						
BC1104	12.5	recessed	–	2	2	
CI1104-B	12.5	–	“B”	2	2	

Device boxes

Conduit knockouts

01 **CI1104-K**
Concentric knockouts.
Recessed ears.

02 **BC1104-LE**
Less ears

03 **CI1104-SB**

04 **BCR2000**

05 **CI3104-KSSX**
Concentric knockouts.
"Wraparound" bracket
for 2 1/2 in. and 3 5/8 in.
steel studs. With integral
support bracket.

06 **BC3104-KSS1X-1**
Concentric knockouts.
"Wraparound" bracket
for 2 1/2 in. and 3 5/8 in.
steel studs. With integral
support bracket.
Brackets positioned for
2 layers of 1/2 in. Drywall.

07 **CI3104-SSX**
"Wraparound" bracket
for 2 1/2 in. and 3 5/8 in.
steel studs. With integral
support bracket.

08 **CI1004**
Recessed ears

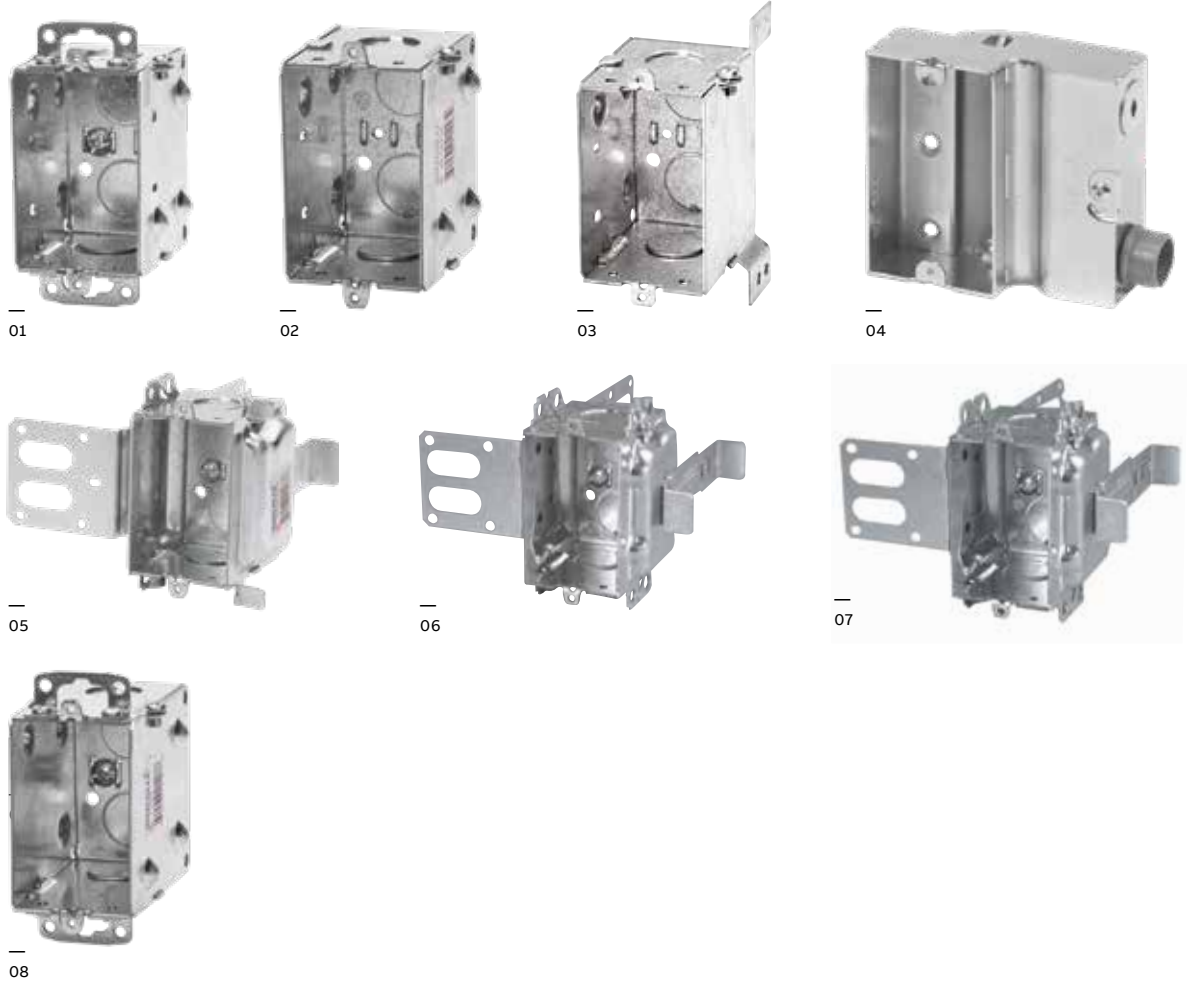

Cat. No.	Volume (Cu. in.)	Ears	Features		Knockouts		
			Bracket		1/2 in. ends	1/2 in. bottom	3/4 in. ends
2 1/2 in. deep – gangable – 3 in. x 2 in.							
CI1104-K	12.5	recessed	-		2	2	2
BC1104-LE	12.5	-	-		2	2	-
CI1104-SB	12.5	-	"SB"		2	2	-
CI3104-KSSX	16.0	-	"SSX"		2	2	2
BC3104-KSS1X-1	16.0	-	"SSX"		2	2	2
CI3104-SSX	16.0	-	"SSX"		2	2	-
3 in. deep – gangable – 3 in. x 2 in.							
CI1004	15.0	recessed	-		2	2	-
CI3004-KSSX-1.25	18.0	-	"SSX"		-	1	2

Cat. No.	Volume (Cu. in.)	Usage	Ground Screw	Knockout
2 in. deep – non-gangable – 3 3/4 in. x 4 in. x 2 in.				
BCR2000*	18.0	KO	2	2

* Supplied c/w one CI4004 connector

Device boxes

Nonmetallic sheathed and armoured cable clamps

- 01 **BC1100-L**
Flush ears.
- 02 **BC1100-LLE**
Less ears
- 03 **CI1100-LRE**
Recessed ears
- 04 **CI425-L**
"Screwlok" brackets for
rework installation.
Max. wall thickness: 5/8 in.
- 05 **BC1102-L**
Flush ears.
- 06 **BC1102-LH**
Provision for
external nailing.



01



02



03



04



05



06



Cat. No.	Volume (Cu. in.)	Features		
		Ears	Bracket	Pryouts ends
1 1/2 in. deep – gangable – 3 in. x 2 in.				
BC1100-L	8.0	flush	–	4
BC1100-LLE	8.0	–	–	4
CI1100-LRE	8.0	recessed	–	4
2 in. deep – gangable – 3 in. x 2 in.				
CI425-L	10.0	flush	rework	4
BC1102-L	10.0	flush	–	4
BC1102-LH	10.0	–	–	4

Device boxes

Nonmetallic sheathed and armoured cable clamps



01



02



03



04



05



06



07



08



09

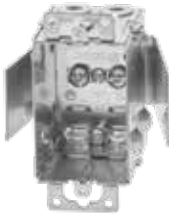

10

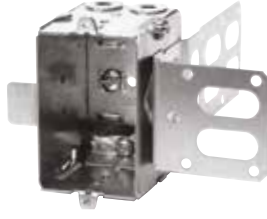

11



12

01 **CI775-L**
Flush ears.

02 **BC775-LD**
"Swing-arm" rework brackets. Max. wall thickness: 3/4 in.

03 **BC777-LRB**
Pivoting ends for rework installation. Max. wall thickness: 1 1/8 in. * Non-Gangable

04 **CI525-L**
"Screwlok" brackets for rework installation. Max. wall thickness: 5/8 in.

05 **BC1104-LB**

06 **BC1104-LHT**
Positioning tabs. Provision for external nailing. Two embossed mounting slots for internal screw installation.

07 **CI1104-LMS**
Mounting strap with prongs. Recessed 1/2 in.

08 **BC1104-LB**
Flush ears.

09 **BC1104-LRB**
Flat sides for rework applications.

10 **BC1104-LRW**
Rework bracket for closed wall applications. Max. wall thickness: 1 in.

11 **BC1104-LSSX**

12 **BC1304-LHTQ**
One screw mounting. Provision for external nailing. Positioning tabs for 1/2 in. and 3/4 in. drywall.



Cat. No.	Volume (Cu. in.)	Ears	Features	ends	Pryouts Knockouts 1/2 in. bottom
			Bracket		
2 1/4 in. deep – gangable – 3 in. x 2 in. – for use with nonmetallic sheathed cable only					
CI775-L	10.0	flush	-	4	1
BC775-LD	10.0	flush	rework	4	1
BC777-LRB*	11.0	-	rework	4	1
2 1/2 in. deep – gangable – 3 in. x 2 in.					
CI525-L	12.5	flush	rework	4	-
BC1104-L	12.5	flush	-	4	-
BC1104-LB	12.5	-	"B"	4	-
BC1104-LHT	12.5	-	P. Tabs	4	-
CI1104-LMS	12.5	-	"MS"	4	-
BC1104-LRB	12.5	flush	-	4	-
BC1104-LRW	12.5	flush	rework	4	-
BC1104-LSSX	12.5	-	"SSX"	4	-
BC1304-LHTQ	14.5	-	P. Tabs	4	-

* Non-Gangable

Device boxes

Nonmetallic sheathed and armoured cable clamps



01



02



03



04



05



06



07



08



09



10



11



12

01 **BC2104-LLE**
Holding prongs and prepositioned depth tabs.

02 **BC2304-LHTQ**
One screw mounting. Provision for external nailing. Positioning tabs for 1/2 in. and 3/4 in. drywall.

03 **BC2104-LX**
Self-locking spring clamps. Holding prongs and prepositioned depth tabs. Raised ground screws. **Approved for nonmetallic sheathed cable only.**

04 **BC2104-LN**
Staked nails. Holding prongs and prepositioned depth tabs.

05 **BC2104-LRB**
Flat sides for rework applications. 1 gang.

06 **BC2104-LLE-2**
2 gang. Holding prongs and prepositioned depth tabs.

07 **BC2104-LRB-2**
Flat sides for rework applications. 2 gang.

08 **BC2104-LLE-3**
3 gang. Holding prongs and prepositioned depth tabs.

09 **BC2104-LLE-4**
4 gang. Holding prongs and prepositioned depth tabs.

10 **BC2304-LHTQ-2**
2 gang. Holding prongs and prepositioned depth tabs.

11 **BC2304-LHTQ-3**
3 gang. Holding prongs and prepositioned depth tabs.

12 **BC2304-LHTQ-4**
4 gang. Holding prongs and prepositioned depth tabs.



Cat. No.	Width (in.)	Volume (Cu. in.)	Ears	Features	
				Bracket	Pryouts ends
2 1/2 in. deep – non-gangable – 3 in. high					
BC2104-LLE	2	12.5	–	P. Tabs	4
BC2104-LLE-2	3 ³ / ₄	25.0	–	P. Tabs	8
BC2104-LLE-3	5-1/2	37.5	–	P. Tabs	12
BC2104-LLE-4	7-3/8	50.0	–	P. Tabs	16
BC2104-LN	2	12.5	–	P. Tabs/Nails	4
BC2104-LX	2	12.5	–	P. Tabs	4
BC2304-LHTQ	2	14.5	–	P. Tabs	4
BC2304-LHTQ-2	3 ³ / ₄	27.0	–	P. Tabs	8
BC2304-LHTQ-3	5-1/2	39.5	–	P. Tabs	12
BC2304-LHTQ-4	7-3/8	52.0	–	P. Tabs	16
BC2104-LRB	2	12.5	–	–	4
BC2104-LRB-2	3 ³ / ₄	25.0	–	–	8

Device boxes

Nonmetallic sheathed and armoured cable clamps



01

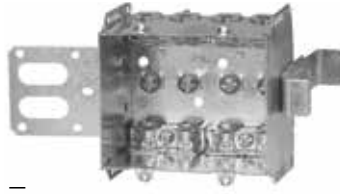

02

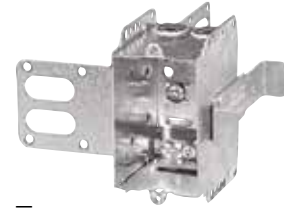

03

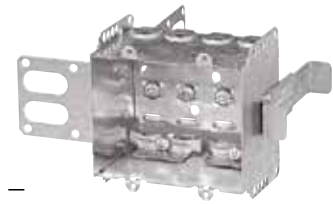

04

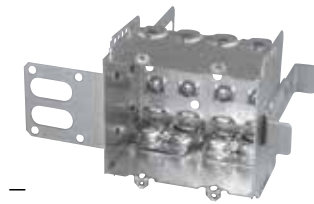

05



06

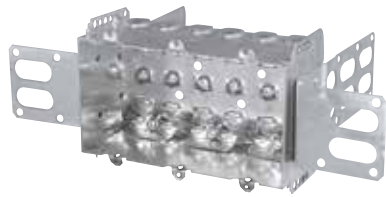

07



08

01 **CI2104-LSSA1X-1**
"Wraparound" bracket for 2 1/2 in. and 3 5/8 in. steel studs. With integral support bracket. **Brackets positioned for 2 layers of 1/2 in. drywall.**

02 **CI2104-LSSA2X-1**
"Wraparound" bracket for 2 1/2 in. and 3 5/8 in. steel studs. With integral support bracket. **Brackets positioned for 2 layers of 1/2 in. drywall.**

03 **CI2104-LSSX**
"Wraparound" bracket for 2 1/2 in. and 3 5/8 in. steel studs. With integral support bracket.

04 **CI2104-LSS2X-1**
"Wraparound" bracket for 2 1/2 in. and 3 5/8 in. steel studs. With integral support bracket. **Brackets positioned for 2 layers of 1/2 in. drywall.**

05 **CI-2104-LSS-2X**
"Wraparound" bracket for 2 1/2 in. and 3 5/8 in. steel studs. With integral support bracket.

06 **CI2104-LSS3X-1**
"Wraparound" bracket for 2 1/2 in. and 3 5/8 in. steel studs. With integral support bracket. **Brackets positioned for 2 layers of 1/2 in. drywall.**

07 **CI-2104-LSS-3X**
"Wraparound" bracket for 2 1/2 in. and 3 5/8 in. steel studs. With integral support bracket.

08 **BC1504-LLE**
Holding prongs and prepositioned depth tabs on one side.



Cat. No.	Width (in.)	Volume (Cu. in.)	Features		
			Ears	Bracket	Pryouts ends
2 1/2 in. deep – non-gangable – 3 in. high					
CI2104-LSSA1X-1	2	12.5	–	"SSX"	4
CI2104-LSSA2X-1	3 3/4	25.0	–	"SSX"	8
CI2104-LSSX	2	12.5	–	"SSX"	4
CI2104-LSS2X-1	3 3/4	25.0	–	"SSX"	8
CI-2104-LSS-2X	3 3/4	25.0	–	"SSX"	8
CI2104-LSS3X-1	5 1/2	37.5	–	"SSX"	12
CI-2104-LSS-3X	5 1/2	37.5	–	"SSX"	12
CI2104-LSS-4X	7 3/8	50.0	–	"SSX"	16
2 1/2 in. deep – non-gangable – 3 in. high					
BC1504-LLE	2 1/4	15.0	–	P. Tabs	4

Device boxes

Nonmetallic sheathed and armoured cable clamps

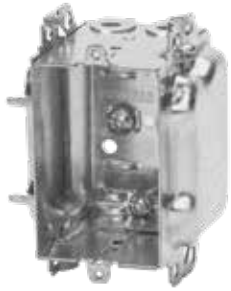

01



02

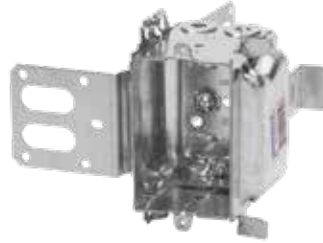

03



04



05



06



07



08

01 BC3104-LH
Positioning tabs. Provision for external nailing.

02 BC3104-LHTQ
One screw mounting. Provision for external nailing. Positioning tabs for 1/2 in. and 3/4 in. drywall.

03 BC3104-LSSX
"Wraparound" bracket for 2 1/2 in. and 3 5/8 in. steel studs. With integral support bracket.

04 CI3104-LSS1X-1
"Wraparound" bracket for 2 1/2 in. and 3 5/8 in. steel studs. With integral support bracket. **Brackets positioned for 2 layers of 1/2 in. drywall.**

05 BC1304-LHT
Provision for external nailing.

06 CI1804-LH
Positioning tabs. External nailing. Mounting slots for internal screw installation. X-Cube adds 5.5 cu. in.

07 BC2004-LH
Provision for external nailing. Holding prongs and prepositioned depth tabs on one side.

08 BC2004-LHTQ
Internally embossed slots for screw mounting. Fixed positioning tabs for single 1/2 in. drywall along with retractable positioning tabs for double 1/2 in. drywall applications. Fixed positioning tabs for outside wall applications. Holding prongs. One screw mounting.



Cat. No.	Volume (Cu. in.)	Features		
		Ears	Bracket	Pryouts ends
2 1/2 in. deep – gangable – 3 in. x 2 in.				
BC3104-LH	16.0	–	P. Tabs	4
BC1304-LHT	14.5	–	P. Tabs	4
BC3104-LHTQ	16.0	–	P. Tabs	4
BC3104-LSSX	16.0	–	"SSX"	4
CI3104-LSS1X-1	16.0	–	"SSX"	4
CI1804-LH	18.0	–	P. Tabs	4
2 3/4 in. deep – non-gangable – 3 3/4 in. x 2 3/16 in.				
BC2004-LH	18.5	–	P. Tabs	4
BC2004-LHTQ	20.5	–	P. Tabs	4

CI3104-LSS1X-1 Top View

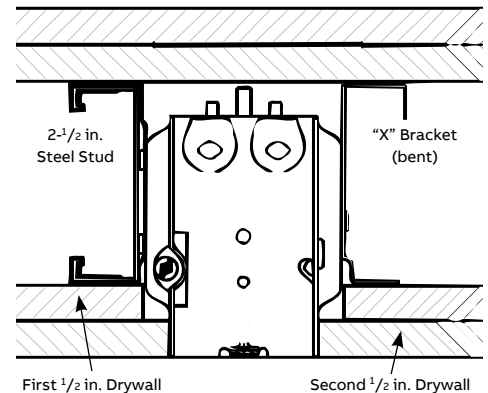

Device boxes

Nonmetallic sheathed and armoured cable clamps

01 **BC1004-L**
Flush ears.



01

02 **BC1004-LH**
Positioning tabs.
Provision for external nailing. Two embossed mounting slots for internal screw installation.



02

03 **CI1004-LB**
Side bracket wood stud.



03

04 **BC1018-LHTQ**
One screw mounting provisions for external nailing.



04

05 **BC3004-LH**
Provision for external nailing.



05

06 **CI3004-LSSX-1**
1 in. recessed brackets for 2 1/2 in. and 3 5/8 in. steel studs. **Brackets positioned for 2 layers of 1/2 in. drywall.**

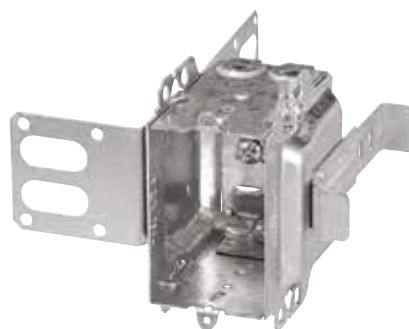

06



Cat. No.	Volume (Cu. in.)	Features		
		Ears	Bracket	Pryouts ends
3 in. deep – gangable – 3 in. x 2 in.				
BC1004-L	15.0	flush	-	4
BC1004-LH	15.0	-	P. Tabs	4
CI1004-LB	16.0	-	"B"	4
BC1018-LHTQ	18.0	-	P. Tabs	4
BC3004-LH	18.0	-	-	4
CI3004-LSSX	18.0	-	"SSX"	4
CI3004-LSSX-1	18.0	-	"SSX"	4
CI3004-LSSAX-1.25*	18.0	-	"SSX"	4

* Brackets positioned for 2 layers of 5/8 in. drywall

CI3004-LSSX-1 Top View

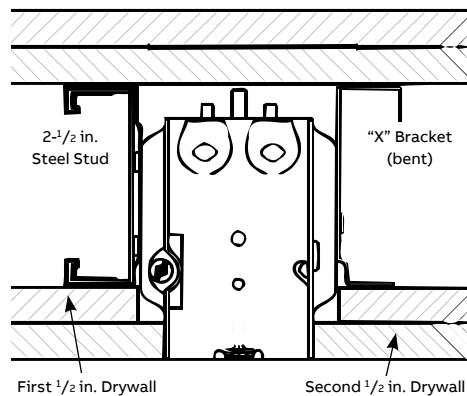

Device boxes

Nonmetallic sheathed and armoured cable clamps

01 **CI3102-LSSAX**

"Wraparound" bracket for 1⁵/₈ in. steel studs. With integral support bracket.

02 **BC1104-LA**

Flush ears.

03 **BC1104-LHA**

Positioning tabs. Provision for external nailing. Two embossed mounting slots for internal screw installation.

04 **CI1104-LMSA**

Mounting strap recessed 1/2 in.

05 **BC1104-LSSAX**

06 **CI3004-LSSAX-1**
1 in. recessed brackets for 2¹/₂ in. and 3⁵/₈ in. steel studs. **Brackets positioned for 2 layers of 1/2 in. drywall.**

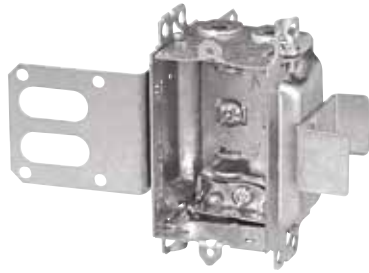

01



02



03



04

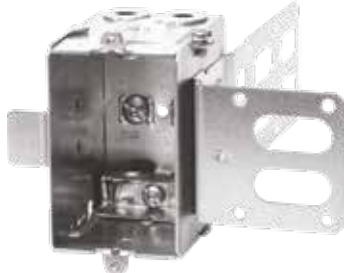

05

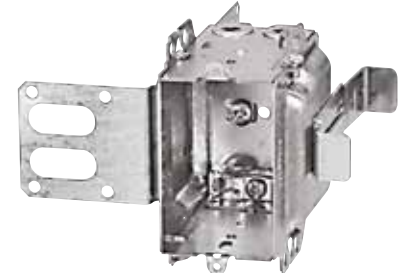

06



Cat. No.	Volume (Cu. in.)	Ears	Features	
			Bracket	Pryouts ends
2 in. deep – gangable – 3 in. x 2 in.				
CI3102-LSSAX	12.0	–	"SSX"	4
2 1/2 in. deep – gangable – 3 in. x 2 in.				
BC1104-LA	12.5	flush	–	4
BC1104-LHA	12.5	–	P. Tabs	4
CI1104-LMSA	12.5	–	"MS"	4
BC1104-LSSAX	12.5	–	"SSX"	4
3 in. deep – gangable – 3 in. x 2 in.				
CI3004-LSSAX-1*	18.0	–	"SSX"	4

* Brackets positioned for 2 layers of 1/2 in. drywall

CI3004-LSSAX-1 Top View

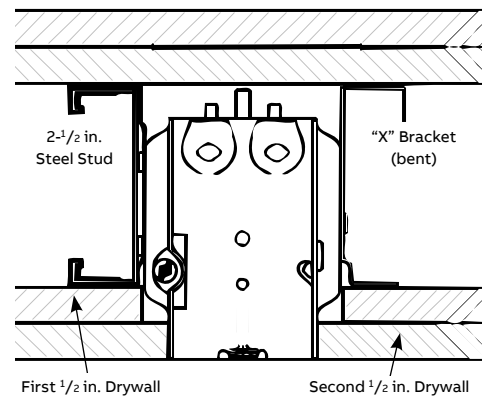

Device boxes

Nonmetallic sheathed and armoured cable clamps

01 CI2104-LSSAX

"Wraparound" bracket for 2 1/2 in. and 3 5/8 in. steel studs. With integral support bracket.

02 CI2104-LSSA-2X

2 gang. "Wraparound" bracket for 2 1/2 in. and 3 5/8 in. steel studs. With integral support bracket.

03 CI2104-LSSA-3X

3 gang. "Wraparound" bracket for 2 1/2 in. and 3 5/8 in. steel studs. With integral support bracket.

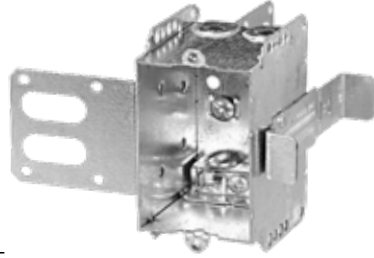

—
01



—
02



—
03



Cat. No.	Width (in.)	Volume (Cu. in.)	Features		
			Ears	Bracket	Pryouts ends
2 1/2 in. deep – non-gangable – 3 in. high					
CI2104-LSSAX	2	12.5	–	P. Tabs	4
CI2104-LSSA-2X	3 3/4	25.0	–	"SSX"	8
CI2104-LSSA-3X	5 1/2	37.5	–	"SSX"	12
CI2104-LSSA-4X	7 3/8	50.0	–	"SSX"	16

Device boxes

Nonmetallic sheathed and armoured cable clamps

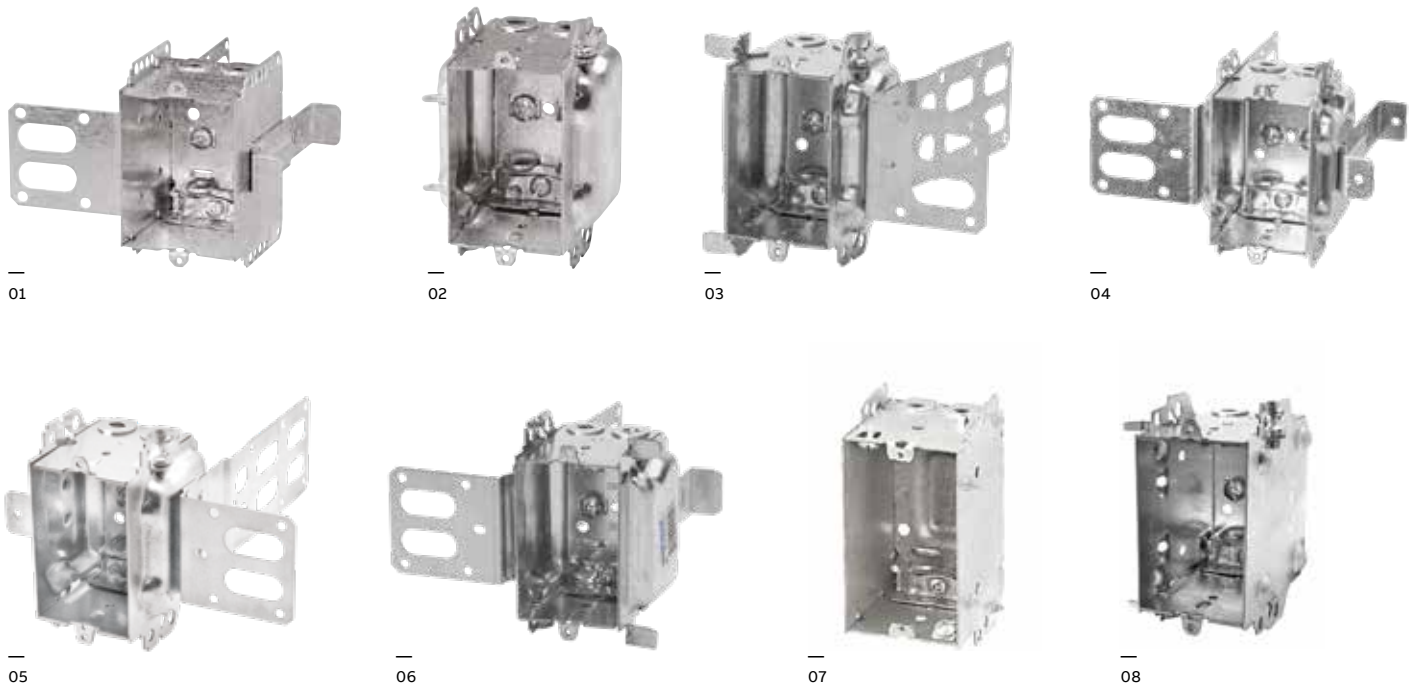

- 01 **CI1504-LSSAX**
"Wraparound" bracket for 2 1/2 in. and 3 5/8 in. steel studs. With integral support bracket.
- 02 **CI3104-LHA**
Positioning tabs. Provision for external nailing.
- 03 **BC3104-LSSAX**
"Wraparound" bracket for 2 1/2 in. and 3 5/8 in. steel studs. With integral support bracket.
- 04 **BC3104-LSSAX-5/8**
Brackets for use with 5/8 in. drywall.
- 05 **CI3104-LSSA1X-1**
1 in. recessed brackets for 2 1/2 in. and 3 5/8 in. steel studs. **Brackets positioned for 2 layers of 1/2 in. drywall.**
- 06 **BC3104-LSSX**
"Wraparound" bracket for 2 1/2 in. and 3 5/8 in. steel studs. With integral support bracket.
- 07 **CI2004-LHA**
Provision for external nailing. Holding prongs and prepositioned depth tabs.
- 08 **CI1004-LHA**
Positioning tabs. Provision for external nailing. Two embossed mounting slots for internal screw installation.



Cat. No.	Volume (Cu. in.)	Ears	Features	
			Bracket	Pryouts ends
2 1/2 in. deep – non-gangable – 3 in. x 2 1/4 in.				
CI1504-LSSAX	15.0	–	"SSX"	4
2 1/2 in. deep – gangable – 3 in. x 2 in.				
CI3104-LHA	16.0	–	P. Tabs	4
BC3104-LSSAX	16.0	–	"SSX"	4
BC3104-LSSAX-5/8	16.0	–	"SSX"	4
CI3104-LSSA1X-1	16.0	–	"SSX"	4
BC3104-LSSX	16.0	–	P. Tabs	4
2 3/4 in. deep – non-gangable – 3 3/4 in. x 2 3/16 in.				
CI2004-LHA	18.5	–	P. Tabs	4
3 in. deep – gangable – 3 in. x 2 in.				
CI1004-LHA	15.0	–	P. Tabs	4

Device boxes

Boxes for ICF construction



BC2104-LMS



BC2104-LMS-2



BC2104-LMS-3



BC2104-LMS-4



BC2104-LMSA



BC2104-LMSA-2



BC2104-LMSA-3



BC2104-LMSA-4



CI3102-LMS



CI3102-LMSA



CI3102-MS



BC52151-KMS



BC54151-LMS



BC54151-LMSA



BC52171-KMS



CI72151-KMS



BC72171-KMS



Cat. No.	Volume (Cu. in.)	Dimensions H x W x D (in.)	Features	Gangable Yes or No
Device boxes				
BC2104-LMS	12.5	3 x 2 x 2 1/2	Loomex/BX	Yes
BC2104-LMS-2	25.0	3 x 3 3/4 x 2 1/2	Loomex/BX	No
BC2104-LMS-3	37.5	3 x 5 1/2 x 2 1/2	Loomex/BX	No
BC2104-LMS-4	50.0	3 x 7 3/8 x 2 1/2	Loomex/BX	No
BC2104-LMSA	12.5	3 x 2 x 2 1/2	BX/Loomex	No
BC2104-LMSA-2	25.0	3 x 3 3/4 x 2 1/2	BX/Loomex	No
BC2104-LMSA-3	37.5	3 x 5 1/2 x 2 1/2	BX/Loomex	No
BC2104-LMSA-4	50.0	3 x 7 3/8 x 2 1/2	BX/Loomex	No
CI3102-LMS	12.0	3 x 2 x 2	BX/Loomex	Yes
CI3102-LMSA	12.0	3 x 2 x 2	BX/Loomex	Yes
CI3102-MS	12.0	3 x 2 x 2	Conduit	Yes



Cat. No.	Volume (Cu. in.)	Dimensions H x W x D (in.)	Features	Gangable Yes or No
Octagonal boxes				
BC54151-LMS	15.0	4 x 4 x 1 1/2	Loomex/BX	No
BC54151-LMSA	15.0	4 x 4 x 1 1/2	Loomex/BX	No



Cat. No.	Volume (Cu. in.)	Dimensions H x W x D (in.)	Knockouts			
			1/2 in. sides	1/2 in. bottom	3/4 in. sides	3/4 in. bottom
Conduit knockouts						
BC52151-KMS	15.0	4 x 4 x 1 1/2	4	2	2	2
BC52171-KMS	30.0	4 x 4 x 2 1/8	4	2	2	2
CI72151-KMS	30.0	4 11/16 x 4 11/16 x 1 1/2	-	2	4	2
BC72171-KMS	42.0	4 11/16 x 4 11/16 x 2 1/8	-	2	4	2

Device boxes

Stainless steel wall plates

General usage



Toggle switch



C197071

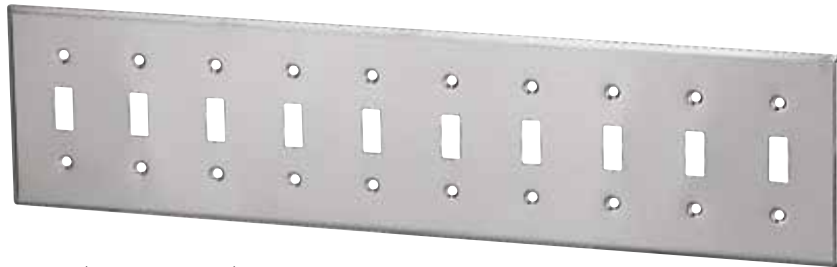

C197080 (1 gang to 10 gangs)

Duplex receptacle



C197101



C197102

Blank box mounting (3.281 in.)



C197011

GFCI / Decora



C197401



C197406 (1 gang to 6 gangs)

Blank device mounting (2.375 in.)



C197121



C197124 (1 gang to 4 gangs)

Combination switch / receptacle



C197532

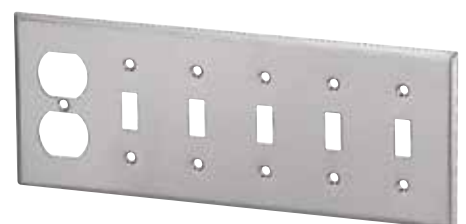

C197573 (2 gangs to 7 gangs)

Device boxes

Stainless steel wall plates



Specialty usage

Telephone



* CI97181
3/8 in. opening

* CI97191
5/8 in. opening

Emergency



CI6851-RF
ON / OFF

Single receptacle



CI97091
1-13/32 in. diameter

GFCI Conversion kit



BC97002
For 4 in. square boxes

* Not applicable.

347 V Toggle specialty usage

For 1204 Series - 1 gang to 4 gangs



CI6851-HV

CI6854-HV

For MBD / MBS Series - 1 gang to 4 gangs



CI6851-HV

CI97074-HVR

347 V Blank

For 1204 Series - 1 gang, 2 gangs and 4 gangs



CI97154-HV

For MBD/MBS Series - 1 gang, 2 gangs and 4 gangs



CI97154-HVR

Device boxes

Stainless steel wall plates

Dimensions

Standard all plate

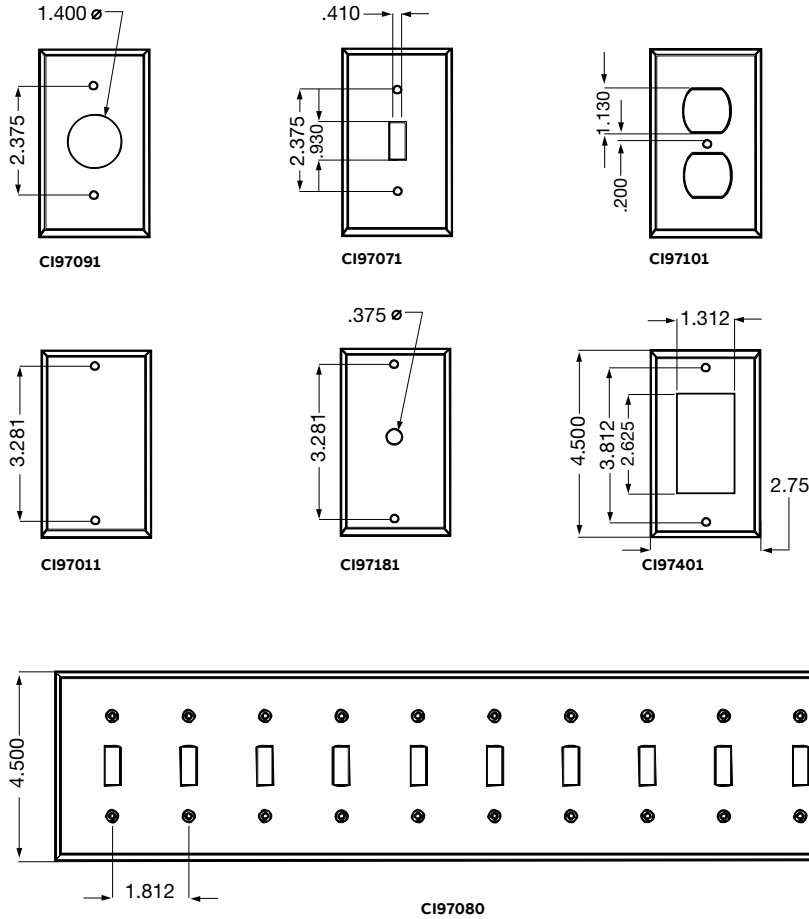

Mounting hole spacings

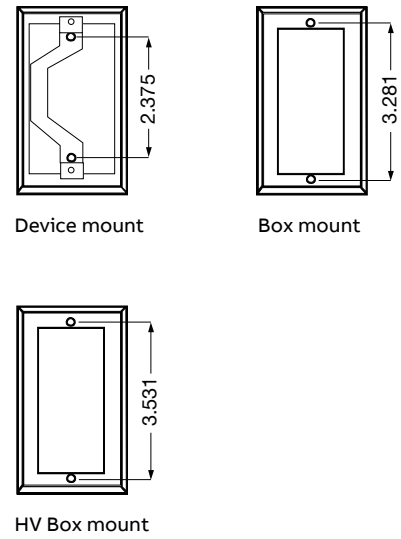

347 V Wall plate

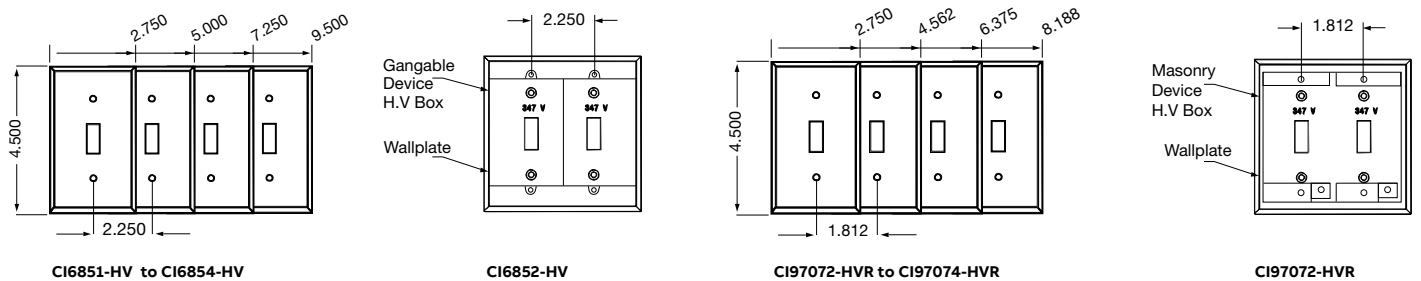

Device boxes

Stainless steel wall plates

Selection guide

Description	1 Gang	2 Gangs	3 Gangs	4 Gangs	5 Gangs	6 Gangs	7 Gangs	8 Gangs	9 Gangs	10 Gangs
Toggle switch	CI97071	CI97072	CI97073	CI97074	CI97075	CI97076		CI97078	CI97079	CI97080
Duplex receptacle	CI97101	CI97102								
Blank boxes										
Mounting 3.281 in.	CI97011	CI97012	CI97013	CI97014						
Blank device										
Mounting 2.375 in.	CI97121	CI97122	CI97123	CI97124						
GFCI / Decora	CI97401	CI97402	CI97403	CI97404	CI97405	CI97406				
GFCI Conversion kit		BC97002								
Combination										
Switch / Receptacle		CI97532			CI97563	CI97573				
15 A Receptacle	CI97091									
Telephone 3/8 in. opening	* CI97181									
Telephone 5/8 in. opening	* CI97191									
Emergency on / off	CI6851-RF									
347 V Toggle										
For 1204 Series	CI6851-HV	CI6852-HV	CI6853-HV	CI6854-HV						
347 V Blank										
For 1204 Series		CI97152-HV		CI97154-HV						
347 V Toggle										
For MBD and MBS Series	CI6851-HV	CI97072-HVR	CI97073-HVR	CI97074-HVR						
347 V Blank										
For MBD and MBS Series		CI97152-HVR		CI97154-HVR						

 * Not applicable.

Technical specifications

Type 430 Stainless steel

- 16% chrome
- Corrosion resistant
- Recommended for industrial, commercial and institutional applications
- Supplied with nickel plated brass screws
- 1 to 3 gangs – Vertically brushed
- 4 gangs and up – Horizontally brushed