

Individual Spec Sheet

WCY

4" LED CYLINDER WALL MOUNT

UPLIGHT, DOWNLIGHT OR UPLIGHT/DOWNLIGHT

ORDERING INFORMATION

Order code: 69150
Model number: WCY-4LS1-Q-3C-BK-P
UPC: 069549024915
Case quantity: 5

PHYSICAL DATA

Size in. : 4
Lens material: Glass Lens
Housing material: Aluminium Die Cast
Mounting: Wall mount, Surface mount

PERFORMANCE DATA

Watts (W): 20
Volts (V AC): 120-347
Color temperature (K)¹: 3 000/4 000/5 000 K
Lumen output (lm)²: 2 445
Efficacy (lm/W): 122
CRI: 80+
Finish: Black
Photocell: Yes
Life L70 (h)³: 50 000
Dimming: Yes
Power factor: ≥0.90
THD (%): ≤20
Frequency (Hz): 50/60
Surge protection (kV): 6
Input current (A): 0.18 - 0.07
Operating temp. range: -40 °C to 40 °C

¹ Typical color temperature range: +/- 5 %.

² Lumen values are derived from photometric testing. Initial lumens range: +/- 10 %.

³ Life hours are derived from IESNA LM80-08 testing report and projected per IESNA TM-21-11 extrapolations.

LUMEN SPECIFICATION TABLE¹

Order code	Model number	Watts (W)	Beam angle (°)	Volts (V)	3 000 K		4 000 K		5 000 K	
					Lumen output (lm)	Efficacy (lm/W)	Lumen output (lm)	Efficacy (lm/W)	Lumen output (lm)	Efficacy (lm/W)
69150	WCY-4LS1-Q-3C-BK-P	20	20	120-347	2 284	113	2 445	122	2 337	117

DEFAULT PROGRAMMING

4 000 K

¹ All lumen values are based on total combined delivered lumens for uplight/downlight distribution selection



IK06



quick ship



wet location



ICES 005



LED fixture



This lighting equipment meets requirements of ICES-005 issue 5 class B for use in residential applications. Data is based upon tests performed in a controlled environment. Actual performance can vary depending on operating conditions. Specifications are subject to change without notice.

INCLUDED IN THE BOX

Optics (two per box)



Front side of optic



Back side of optic

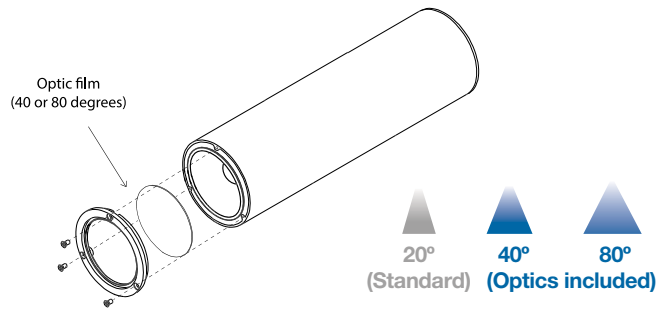

DIMENSIONS AND WEIGHT

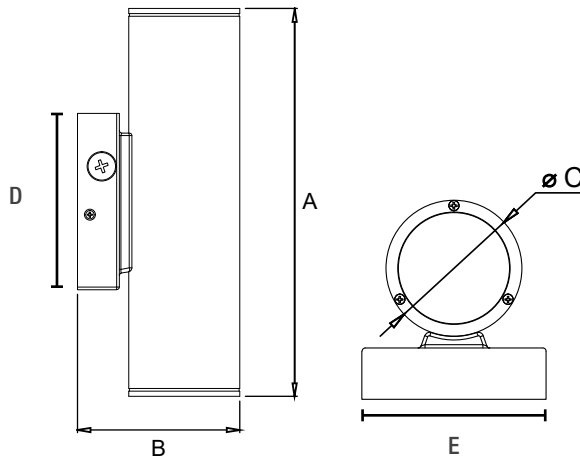

A in. (cm)	11 3/4 (29.7)
B in. (cm)	4 7/8 (12.5)
C in. (cm)	3 3/8 (8.5)
D in. (cm)	4 1/2 (11.5)
E in. (cm)	4 1/2 (11.5)
Net weight (lbs)	2.9

PHOTOMETRIC DATA¹

69150 • WCY-4LS1-Q-3C-BK-P • 20 W • 4 000 K • 2 445 lm

Polar candela distribution

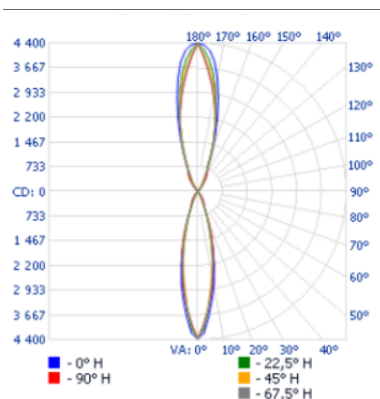

Zonal lumen summary

Zone	Lumens	% Fixture
0-30	938.2	38.4
0-40	1 013.1	41.4
0-60	1 053.6	43.1
60-90	14.7	0.6
70-100	7.3	0.3
90-120	18.6	0.8
0-90	1 068.2	43.7
90-180	1 376.5	56.3
0-180	2 444.7	100

Illuminance at a distance

Center beam fc		Beam width
17.0'	15.1	
34.0'	3.78	16.5'
51.0'	1.68	24.7'
68.0'	0.95	33.0'
85.0'	0.60	41.2'
102.0'	0.42	49.5'

■ Horiz. spread : 27.3°

¹ Complete IES files available on our website.

Qty	Description	Price

I accept the specifications of the luminaire configuration mentioned above.

Name: _____
 Company: _____
 Signature: _____

Date: _____

Data is based upon tests performed in a controlled environment. Actual performance can vary depending on operating conditions. All products are subject to change or may be discontinued any time without notice. Please contact your Stanpro customer service representative to confirm inventory levels at time of order.