

TECHNICAL & SERVICE MANUAL V5.0

—CONTROLLERS

Models:

Wired Controller

YXE-A03U(E)
YXE-C01U1(E)
YXE-C02U1(E)
YXE-E01U(E)
YXE-E02U(E)

Central Controller

YXE-C03U(E)
YJE-C01T(E)

Control Box

B541(E)
B542(E)
B543(E)
B544(E)

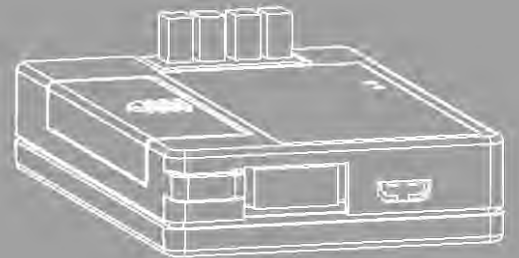

Table of Contents

1. Controller Function List	1
2. Wired Controller	3
2.1 YXE-A03U(E)	3
2.1.1 Function Introduction	3
2.1.2 Installation Manual	9
2.1.3 Checking and Setting	10
2.2 YXE-C01U1(E)	14
2.2.1 Function Introduction	14
2.2.2 Installation Manual	24
2.2.3 Checking and Setting	26
2.3 YXE-C02U1(E)	31
2.3.1 Function Introduction	31
2.3.2 Installation Manual	41
2.3.3 Checking and Setting	42
2.4 YXE-E01U(E)/YXE-E02U(E)	48
2.4.1 Function Introduction	48
2.4.2 Installation Manual	55
2.4.3 Checking and Setting	57
3. Central Controller	62
3.1 YXE-C03U(E)	62
3.1.1 Function Introduction	62
3.1.2 Installation Manual	72
3.1.3 Checking and Setting	74
3.2 YJE-C01T(E)	79
3.2.1 System Introduction	79
3.2.2 Function Introduction	80
3.2.3 Installation Manual	91
4. Control Box	94
4.1 B541(E)	94
4.2 B542(E)	97
4.3 B543(E)	99
4.4 B544(E)	102
5. Trouble Shooting	115
6. Outlines and Dimensions	117

1. Controller Function List

Controller Category	Pair Controller				Simplified Central Controller	Central Controller
	YXE-A03U(E)	YXE-C01U1(E)	YXE-C02U1(E)	YXE-E01U(E)		
Main function	Max Connectable Indoor Unit	1	1	1	4	16
	Modes : On/Off/Cooling/Heating/Dry/Fan/Auto Fan	●	●	●	●	●
	Temperature Setting	●	●	●	●	●
	Timer	●	●	●	●	●
	Sleep	●	●	●	●	●
	Weekly Schedule	x	●	●	x	●
	Error Code Display	●	●	●	●	●
	One Error Shielded	●	●	●	●	●
	Check	●	●	●	●	●
	Wireless Remote Receive	●	●	x	●	●
	Wireless Remote Receive Forbid	x	●	x	●	x
	Touch Lock/Bottom Lock	●	●	●	●	●
	Operation Monitor	●	●	●	●	●
	Filter Cleaning Remind	●	●	●	●	●
	Filter Cleaning Timing	●	●	●	●	●
	°C/F	●	●	●	●	●
	Temperature Display switching	●	●	●	●	●
	Clock	x	●	●	x	●
	Mode Lock	●	●	●	●	●
	Temperature Range Limit	●	●	●	●	●
	Temperature Range Limit Forbid	x	●	●	●	●
	Central & Group Controlled	x	x	●	x	x
	Central & Group Controller	x	x	x	x	●
Address Setting (For Controlled)	x	x	●	x	●	
Simplified Central Controller	x	x	x	x	x	
I Feel	●	●	●	●	●	
Temperature Compensation	●	●	●	●	●	
Temperature Compensation forbid	x	●	●	●	●	
High Ceiling Function	●	●	●	●	●	

1. Controller Function List

Controller Category	Pair Controller				Simplified Central Controller	Central Controller
	YXE-A03U(E)	YXE-C01U1(E)	YXE-C02U1(E)	YXE-E01U(E)		
Duct Static Pressure Setting	●	●	●	●	●	●
On-off Setting	●	●	●	●	●	●
Auto restart	●	●	●	●	●	●
Alarm On Or Off	●	●	●	●	●	●
Dimer	●	●	●	●	●	●
Mute	x	●	●	●	●	●
Powerful	x	●	●	●	●	●
Up and Down Swing	●	●	●	●	●	●
Left and Right Swing	●	●	●	●	●	●
LCD Screen	●	●	●	●	●	●
Compact 86x86x15	●	x	●	●	x	x
Big 120x120x20	x	●	●	x	●	●
DC 12-17V	●	●	●	●	●	x
AC 175-264V	x	x	x	x	x	●
Distance To The Indoor Unit	40m	40m	40m	40m	40m	40m
Built-in Backup Power	x	x	x	x	x	x
BACnet	x	x	●	x	x	●

2. Wired Controller (YXE-A03U(E))

2.1 YXE-A03U(E)

2.1.1 Function Introduction

Part Names

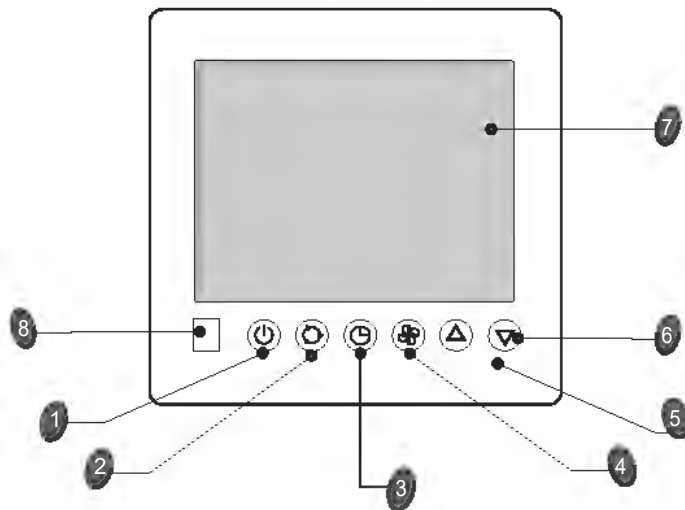

- 1 ON/OFF BUTTON**
The appliance will be started when it is energized or will be stopped when it is in operation, if you press this button.
- 2 MODE BUTTON**
Press this button to select the operation mode.
- 3 TIMER BUTTON**
Used to set the current time or set timer ON/OFF.
- 4 FAN BUTTON**
Used to select fan speed.
- 5 INCREASE SETTING BUTTON**
Used to raise the set temperature;
It changes the TIMER ON/OFF settings and WEEKLY TIMER settings.
- 6 DECREASE SETTING BUTTON**
Used to lower the set temperature;
It changes the TIMER ON/OFF settings and WEEKLY TIMER settings.
- 7 LIQUID CRYSTAL DISPLAY(LCD) SCREEN**
Used to display indicator screens.
- 8 RECEIVING WINDOW**
Infrared ray receiving window.

2. Wired Controller(YXE-A03U(E))

LCD Screen

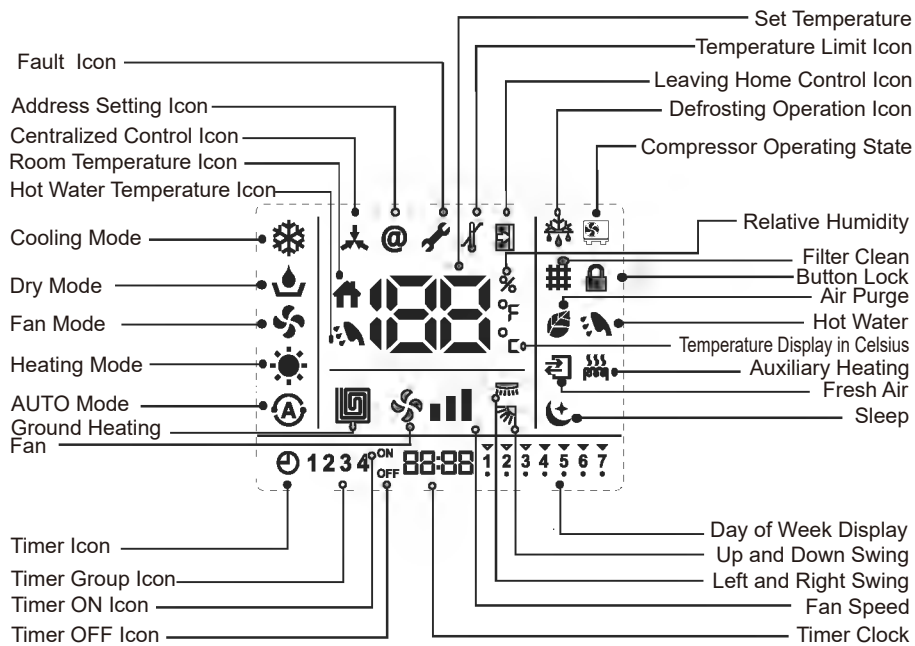

NOTE:

1. Functions related to heating and electrical auxiliary heating are unavailable on cooling only air conditioners.
2. Swing, strainer cleaning, hot water, ground heating, fresh air, freshness, and electrical auxiliary heating functions depend on model, please refer to specific description of models.
3. Troubleshooting, address and °F temperature shall be set by professional installation maintenance personnel.
4. Leaving home control, centralized control, timing group and week timing are reserved functions.

2. Wired Controller(YXE-A03U(E))

Simple Operation

This wired remote controller should be used with the air conditioner, and it can be used for cooling, heating, drying and fan, etc. For other functions and settings, please refer to the specific operation in this manual.

1. ON/OFF

Press ON/OFF button , and the appliance will start to operate; once this button is pressed again, the appliance will stop operating.

2. Mode Setting

Used to select different operating modes and switch between cooling – dry – fan – heating and AUTO. Every time the mode button  is pressed, the operating mode will change in the following sequence:



NOTE:

AUTO mode is unavailable on some of the models and will be invalid during mode setting. For cooling only and heating disabled models, heating mode is invalid during mode setting.

3. Temperature Setting

Press "" or "" button to enter temperature setting state.

Each time "" button is pressed, the temperature setting rises by 1°C;

Each time "" button is pressed, the temperature setting lowers by 1°C;

Temperature setting is finished 3 seconds after the set temperature value blinking.

Range of Temperature Setting	
*HEATING, COOLING, DRY	16°C~30°C
FAN	Unable to set

*:

1. Heating mode is ineffective for COOLING ONLY models.

2. The default setting range depends on indoor unit.

3. When the set temperature exceeds the range mentioned above, the set temperature cannot be increased or decreased anymore and icon  will be displayed on the liquid crystal display.

4. Fan Speed Setting

Press the fan speed button "" in ON state to adjust the fan speed. The fan speed will change in the following order:



NOTE:



AUTO fan is invalid for "FAN" mode.

AUTO fan speed is the default setting in DRY mode, and it can not be adjusted.

2. Wired Controller(YXE-A03U(E))



5. Airflow Swing Setting

Up and Down Swing

Press “” button and “” button simultaneously under ON state to set the air direction of Up and Down swing, then the air direction will change in the following order:



Left and Right Swing

Press “” button and “” button simultaneously under ON state to set the air direction of Left and Right swing, then the air direction will change in the following order:

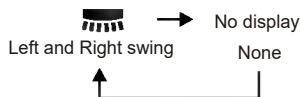

NOTE:



This function is only available for the air conditioners with Swing function.



Function Setting

Sleep Function Setting

With the sleep function, the air conditioner will run in the mode of comfortable sleep to improve comfort.

Operations:

Press “” button when the appliance is on to set the sleep function. The icon “” will be displayed on the LCD, indicating that sleep mode is activated.

Press “” button again to cancel the sleep function. The icon “” will disappear from LCD, indicating that sleep mode has been cancelled.

TIPS:

If you want to advance the time to disenable sleep function, please set timer OFF while setting the sleep function. For specific operations, please refer to the “Timer OFF setting”.

NOTE:

Sleep function is not available in FAN mode or AUTO mode.

Timer ON Setting

Hold down “” button for 3s in OFF state to enter timer ON setting.

“” icon appears on display, timer ON icon “ON” and timer time flicker simultaneously.

The time increases by 30min every time “” button is pressed;

The time decreases by 30min every time “” button is pressed.

The setting interval is 30min and setting time range is 0:00-24:00.

After the desired time is reached, press “” button. After timer ON operation is completed, timer icon will appear at the bottom-left corner of the screen.

You can press “” or “” or “” button at any time during setting to cancel timing ON and exit.

The settings will be exited and saved when no button is pressed within 10s.

NOTE:

If you press  to turn on manually after timer ON setting is completed, timer ON will be cancelled.

Timer OFF Setting



Hold down timer button “” for 3s in ON state to enter timer OFF setting. “” icon appears on display, timer OFF icon “OFF” timer time flickers simultaneously.

The time increases by 30min every time “” button is pressed;

The time decreases by 30min every time “” button is pressed.

The setting interval is 30min and the setting time range is 0:00-24:00.

When the desired time is reached, press “” button. When timer ON operation is completed, timer icon will appear at the bottom-left corner of the screen.

You can press “” or “” or “” button at any time during setting to cancel timing OFF and exit.

The settings will be exited and saved when no button is pressed within 10s.

NOTE:

If you press  to turn off manually after timer OFF setting is completed, timer OFF will be cancelled.

2. Wired Controller(YXE-A03U(E))

Auxiliary Heating Setting

In ON state, when the air conditioner is in heating mode, hold down “☺” button for 3s to select manual auxiliary heating function. The auxiliary heating function will change in the following order:

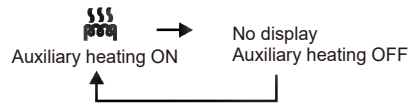

When auxiliary heating is set to “ON”, the auxiliary heating icon  will light up. It either displays or disappears according to the actual state after 5 minutes (auxiliary heating may not start as the internal control condition is not satisfied);

After auxiliary heating is set to “OFF”, the auxiliary heating icon  will disappear and auxiliary heating will be turned off immediately.

NOTE:

1. This function is only available for the models with auxiliary heating function and can be selected only in heating mode.
2. If auxiliary heating function is not set manually, the default setting of the unit is to enable or disable auxiliary heating function automatically according to external ambient temperature and other conditions.
3. After mode switching, power outage and ON/OFF operation, setting of manual auxiliary heating function will be cleared.

Button Lock Setting

After setting of wired controller is completed, you can set the button lock to prevent children or others from operating mistakenly. After button lock is set, any operation to the wired controller will be invalid. Hold down “△” key and “▽” key for 3s simultaneously to set the button lock. Repeat the operation again to cancel lock.

Filter Clean and Resetting

(Applicable to the existing filter hint function and shall be carried out by professionals)

When the filter needs to be maintained and washed, filter clean icon  will appear on screen of the wired controller.

Please contact professionals to carry out maintenance of the filter. After completion, hold down “☺” button for 3s, then the buzzer will beep for four times to hint that the filter has been cleaned and reset.

NOTE:

Filter hint is only available to some of the models. For its washing, cleaning and replacement, please read indoor unit operation instructions for details. During washing and maintenance, please always stop operation of the air conditioner and turn off the power supply.

2. Wired Controller(YXE-A03U(E))

Maintenance

- Wipe the LCD or the body of the wired remote controller with a dry cloth.
- If the dirt on the surface cannot be removed, soak the cloth in neutral detergent diluted with water, squeeze the cloth tightly, and clean the surface. Wipe the surface with a dry cloth.
- Do not use any thinner, organic solvents, or strong acid.

Troubleshooting and After-sales Service

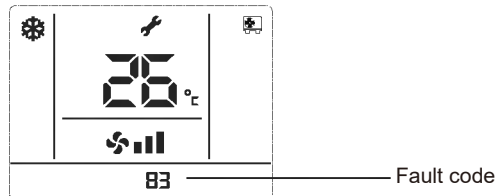

When the air conditioner operates abnormally,  sign will appear on the liquid crystal display of the wired controller, fault code will be displayed and faults will be hinted on the liquid crystal display. Please write down the fault codes and contact after-sales service.

- As for after-sales service, please consult your local dealer or after-sales service.

2. Wired Controller(YXE-A03U(E))

2.1.2 Installation Manual

Install it by professionals and confirm that the power supply has been turned off before installation. This product shall be installed in a well-ventilated environment and kept far away from heat source. During installation, always confirm that the wired controller and indoor unit of the air conditioner controlled by it are in the same room.

Please install it as per the following procedures:

- Insert a small slot type screwdriver to the square notch under the wired controller to loosen the lower part of the rear cover;
- Loosen the upper part of the rear cover to remove the rear cover;
- Secure the rear cover to specified location and connect the line of communication;
- Secure the upper end of the front cover;
- Press the lower end of the front cover into the rear cover and reinstall the front cover.

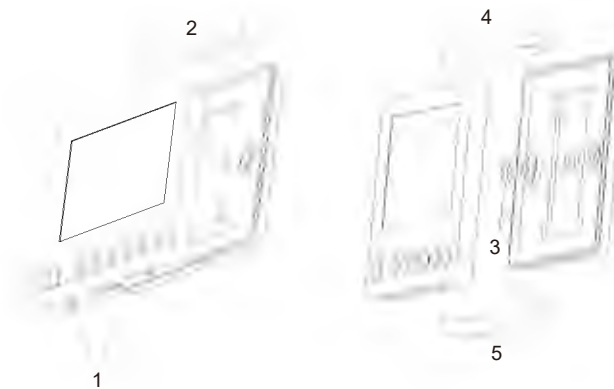

Wiring Instructions

- Pin 1 and 2 on socket on the control panel of the wired controller corresponds with the signal lines of the connecting wire, while pin 3 corresponds with the positive pole of the power supply for connecting wire and pin 4 corresponds with the negative pole of the power supply for connecting wire.
- When the connecting wire needs to be extended, please make sure that the line sequence of the two terminals is the same.

2. Wired Controller(YXE-A03U(E))

2.1.3 Checking and Setting

Indoor Unit Parameter Checking

The internal parameters of the air conditioner can be read with the following method.

Instruction

1. Hold down Mode button and Fan button for 3s simultaneously to enter parameters customer-reading state, then customer-reading parameter codes will display in the temperature display area.(See fig.1)

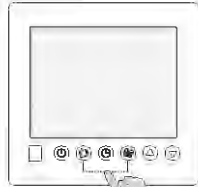

fig.1

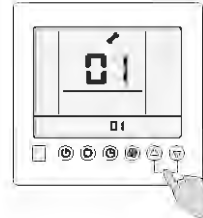

fig.2

2. Press Up or Down button to adjust to the customer-reading parameter code to read. For detailed information, please refer to Table 1. For example, the picture below means that it is a duct indoor unit. (See fig.2)

Table 1

Customer-reading Parameter Code	Implication of Code Display	Description
01	Indoor unit kind	00H: Wall mounted; 01H: Ducted; 02H: Cassette; 03H: Ceiling & Floor; 04H: Floor Standing; 05H: ATW;
06	IDU environment temperature	°C
07	IDU coil temperature	°C
08	ODU environment temperature	°C
09	Discharge temperatur	°C
11	ODU coil temperature	°C
14	EEV step	
23	I feel temperature by wired controller	°C
24	Error code	
25	Sub-error code of driving board error E45	

3. Press ON/OFF button to quit customer-reading state. (See fig.3)

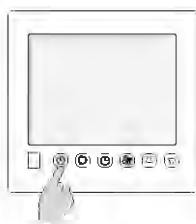

fig.3

2. Wired Controller(YXE-A03U(E))

Indoor Unit Parameter Setting

The internal parameters of the air conditioner can be set with the following method.

Instruction

1. Hold down Mode button and Fan button for 3s simultaneously to enter parameters customer-reading state, then customer-reading parameter codes will display in temperature display area. (See fig.4)

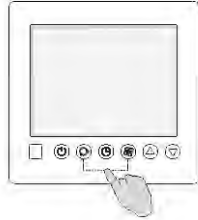

fig.4

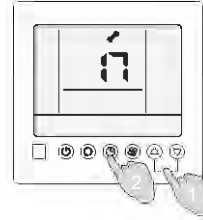

fig.5

2. Press Up or Down button to adjust to the customer-setting parameter code 17, press timer button to enter the state to set this parameter, then its function code will flicker. (See fig.5)
3. Press Up or Down button to adjust to the detailed customer-setting parameter code to set. Press timer button to enter the detailed state to set this parameter. For detailed information, please refer to Table 2. For example, the picture below means that it is to open self-recovery function by changing EE 00 to EE 01. (See fig.6)

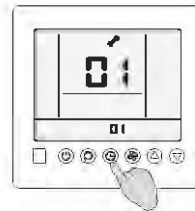
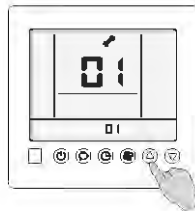
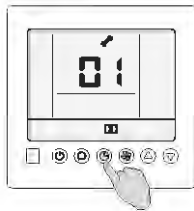

fig.6

4. Press ON/OFF button to quit customer-reading state to #17, then press ON/OFF button to quit customer-setting state.(See fig.7)

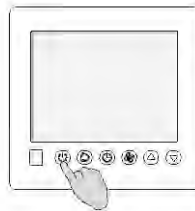

fig.7

2. Wired Controller(YXE-A03U(E))

Table 2









Parameter Code	Parameter Description	Parameter Value&Representation		NOTE
		Data Type	Representation (Function Code)	
1	Self recovery of power break	Integer	0: Cancel self recovery of power break function; 1: Self recovery of power break; others: invalid.	
2	Temperature type	Integer	0: Centigrade temperature; 1: Fahrenheit temperature; others: invalid.	
3	Temperature display type	Integer	0: Default display set temperature; 1: Default display room temperature; others: invalid.	
4	Ratio of ambient temperature sensed by indoor temperature sensor(cooling mode)	Integer	0~10valid, more than 10default is 10 0:0%; 1:10%;...; 10:100%	0:entirely use temperature sensed by wired remote controller; 10:entirely use temperature sensed by indoor unit
5	Filter clean indication	Integer	0: Default display set temperature 1: Default display room temperature others: invalid	
6	Filter clean time set	Integer	0~32, more than 32 default is 32*1000h	
7	Installation height compensation	Integer	0~10m, more than 10m default is 10. =0,1,2: no fan speed compensation =3: increase fan speed =4~10: increase more fan speed	
8	Cooling temperature compensation(indoor unit temperature sensor)	Integer	0: 0°C;1:-0.5°C;2:-1°C;3:-1.5°C;4:-2°C; 5:-2.5°C;6:-3.0°C;7:-3.5°C;8:-4°C;9:-4.5°C; 10:-5°C (the wired controller displays integer with symbol)	
9	Heating temperature compensation(indoor unit temperature sensor)	Integer	0: 0°C;1:-0.5°C;2:-1°C;3:-1.5°C;4:-2°C; 5:-2.5°C;6:-3.0°C;7:-3.5°C;8:-4°C;9:-4.5°C; 10:-5°C (the wired controller displays integer with symbol)	
10	Static pressure set	Integer	1~250, function code=static pressure more than the limit static pressure default the limit static pressure, default is 0 (default static pressure, related to models)	Duct type(DC motor)
12	Ratio of temperature sensed by indoor temperature sensor(heating mode)	Integer	0~10valid, more than 10 default is 10 0:0%; 1:10%;...; 10:100%	0:entirely use temperature sensed by wired remote controller; 10:entirely use temperature sensed by indoor unit
13	Temperature adjustment-cooling	Character	-10~10°C (single character with symbol)	Temperature displayed on wired controller
14	Temperature adjustment-heating	Character	-10~10°C (single character with symbol)	Temperature displayed on wired controller
25	Access control, fire protection, ON/OFF function set	Integer	=0, access control, fire protection functions are all invalid; =1, access control function is valid; =2, fire protection function is valid; =3, access control, fire protection are all valid; =4, ON/OFF function are all valid.	

2. Wired Controller(YXE-A03U(E))

Self-setting Parameter

The internal parameters of the wired remote controller can be set with the actual usage conditions.

Methods to set custom-setting parameters:

1. Hold down mode button  and timer button  for 3s simultaneously to enter parameters custom-setting state, then custom-setting parameter codes will display in the temperature display area;
2. Press  or  button to adjust to the custom-setting parameter code to be set, press timer button  to enter the state to set this parameter, then its function code will flicker;
3. Press  or  button to adjust the function code and press timer button  to confirm, then the setting is completed.

The custom-setting parameters list is shown as below:

Custom-setting Parameter Code	Implication of Code Display	Description	Remarks
01	Version No.		
03	boot	Restore factory setting	
05	Remote control/button operation setting is allowed or not	00-Remote control/button operation is enabled; 01-Remote control is disabled; 02-Button operation is disabled; 03-Remote control/button operation is disabled.	
06	Temperature display setting	00-Display the set temperature; 01-Display the indoor environment temperature	The factory setting defaults to 0
07	Temperature measurement unit display setting	00-Display in Celsius; 01-Display in Fahrenheit degree	
08	Cooling only setting	00-Heat pump type air conditioner; 01-Cooling only air conditioner	
13	Buzzer setting	00-Buzzer is valid; 01-Buzzer is invalid	
14	Backlight setting	00-Backlight is valid; 01-Backlight is invalid	

2. Wired Controller(YXE-C01U1(E))

2.2 YXE-C01U1(E)

2.2.1 Function Introduction

Part Names

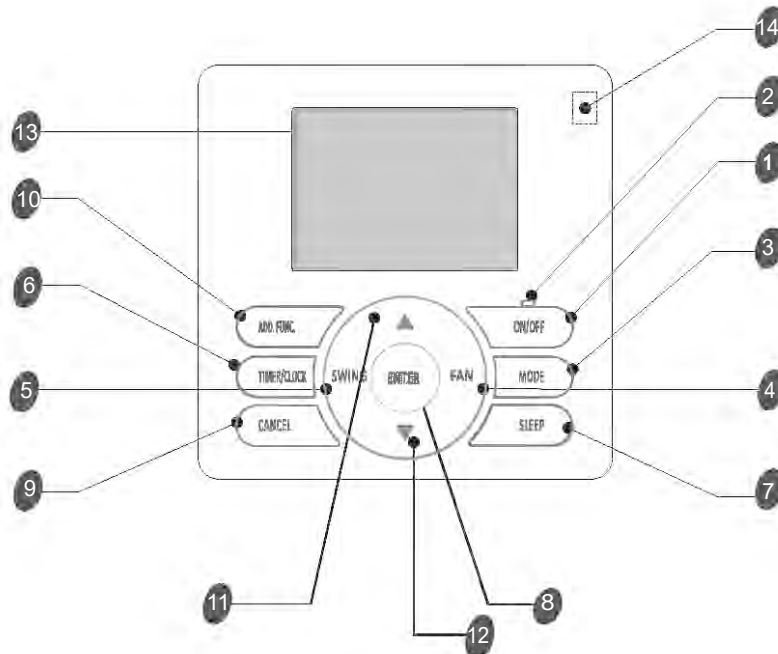

- 1 ON/OFF BUTTON**
The appliance will be started or stopped when this button is pressed.
- 2 RUN INDICATOR**
Indicates that the appliance is on.
- 3 MODE BUTTON**
Press this button to select the operation mode.
- 4 FAN BUTTON**
Used to select fan speed in sequence high-auto-low-medium-high.
- 5 SWING BUTTON (Invalid for some models)**
Used to stop or start adjustment louver swinging and set the desired airflow direction.
- 6 TIMER/CLOCK BUTTON**
Used to set the current time or set Timer ON/OFF.
- 7 SLEEP BUTTON**
Used to set or cancel Sleep Mode operation.
- 8 ENTER BUTTON**
Used to confirm settings.
- 9 CANCEL BUTTON**
Used to cancel settings.
- 10 ADD.FUNC. BUTTON (Invalid for some models)**
Used to set filter cleaning, hot water, fresh air, electric heater, etc.
- 11 INCREASE SETTING BUTTON**
Used to raise the set temperature;
It raises the values when setting.
- 12 DECREASE SETTING BUTTON**
Used to lower the set temperature;
It lowers the values when setting.
- 13 LIQUID CRYSTAL DISPLAY(LCD) SCREEN**
Used to display indicator screens.
- 14 BUILT-IN INFRARED SIGNAL RECEIVER**
Used to receive infrared signal.

2. Wired Controller(YXE-C01U1(E))

LCD Screen

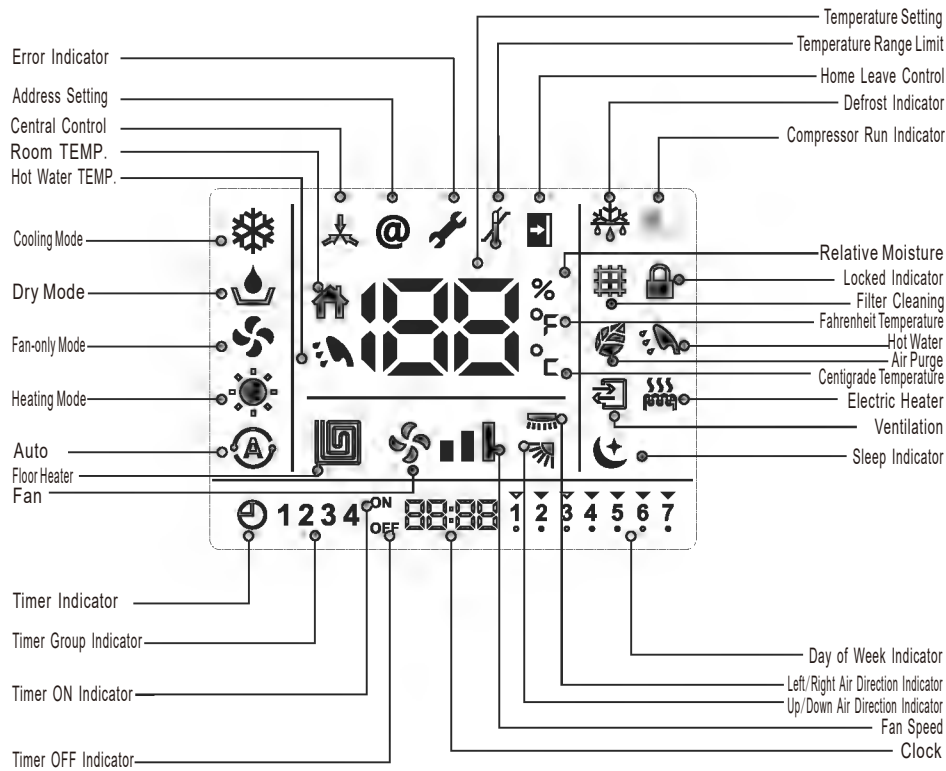

NOTE:

1. For purpose of explanation, all parts of the display are shown. During actual operation, only the relevant items will be displayed.
2. Heating and electric heating function are not available for cooling only models.
3. Air Direction, Filter Cleaning, Hot Water, Floor Heat, Ventilation, Electric Heating etc. are only effective for dedicated models. For details, please refer to the operation manual.
4. ERROR and Maintenance, Address Setting, Central Control, TEMP. Range Limit, Fahrenheit Temperature should be set by the dealer.

2. Wired Controller(YXE-C01U1(E))

Simple Operation

This wired remote controller should be used with the air conditioner, and it can be used for cooling, heating, drying and fan, etc. For other functions and settings, please refer to the specific operation in this manual.

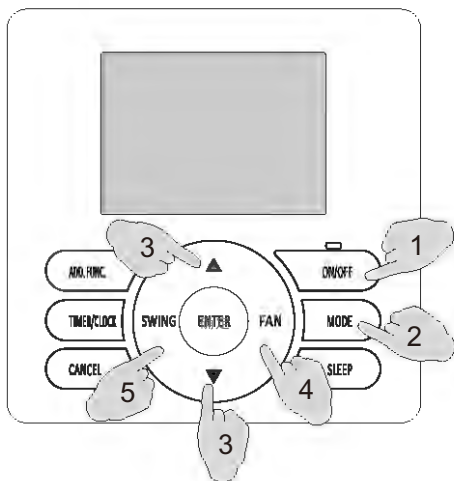

1. Turning ON/OFF

<To start operation>

Press the ON/OFF button, the ON lamp lights up, and the appliance will be started.

<To stop operation>

Press the ON/OFF button again, the ON lamp goes off, and the appliance will be stopped.

Hold down "ON/OFF" button for more than 3 seconds, and the appliance will enter completely shutdown state.

(When indoor unit stops, you cannot use Timer ON to start, but start it manually), the buzzer beeps for 4 times.

2. Mode Setting

Press "MODE" button to select modes.

Each time MODE button is pressed, the operation mode changes in sequence below:



NOTE:

AUTO mode is invalid for models without AUTO mode when setting.

HEATING mode is invalid for cooling only types or heating-forbidden air conditioners.

3. Temperature Setting

Under ON conditions or under OFF conditions where TIMER ON function is enabled.

Press "▲" or "▼" button to enter the temperature setting state.

Each time "▲" button is pressed, temperature setting rises by 1°F/1°C;

Each time "▼" button is pressed, temperature setting lowers by 1°F/1°C;

Range of Temperature Setting	
HEATING, COOLING, DRY, AUTO	61°F~86°F(16°C~30°C)
FAN ONLY	Unavailable for setting

NOTE:

1) Heating mode is ineffective for COOLING ONLY models.

2) The default setting range depends on the indoor unit.

3) Setting range can be changed by professional stuff, please contact installation service when needed.

4) When setting temperature is above setting range, will display on the LCD, the set temperature will not rise or lower any more.

4. Fan Speed Setting

Under ON conditions or under OFF conditions where TIMER ON function is enabled, press

the "FAN" button to adjust the fan speed. The fan speed will change in the following sequence:

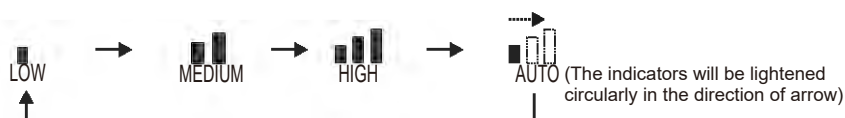

2. Wired Controller(YXE-C01U1(E))

5. Airflow Direction Setting

Under ON conditions or under OFF conditions where TIMER ON function is enabled, press the “SWING” button to adjust the airflow direction. The airflow direction setting will change in the following sequence by default:



NOTE:

1. This setting is only effective for units with this swing function.
2.  is only available for specific models.

Function Setting

Super Mode

The maximum cooling/heating capacity can be activated in the super mode.

How to activate:

Press the “▲” button for 3s under ON conditions to activate the super mode, and the indoor unit will run at the ultrahigh fan speed, and icon  will flicker on the display.

If you operate the Super mode under COOLING, DRY and FAN ONLY modes, the unit will automatically go into forced cooling mode with the lowest set temperature, or go into forced heating mode with the highest set temperature in heating mode.

How to cancel:

Press “ON/OFF”/“MODE”/“SLEEP”/“FAN” button to exit immediately.

NOTE:

For the indoor units without ultrahigh fan speed function, it will be adjusted to run at high fan speed in Super mode, with high fan speed mode icon  displayed.

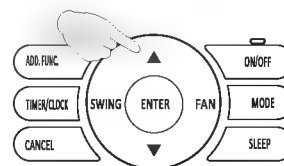

Silence Mode

The silence running mode reduces the noise by changing the fan speed of indoor unit so as to keep quiet during operation at night.

How to activate:

In COOLING/HEATING modes during appliance operation, press the “▼” button for 3s to activate silence mode, the indoor unit will run at the ultralow fan speed, and icon  will flicker on the display.

How to cancel:

Press “ON/OFF”/“MODE”/“SLEEP”/“FAN” button to exit.

NOTE:

For the indoor units without ultralow fan speed function, it will be adjusted to run at low fan speed in silence mode, with low fan speed mode icon  displayed.

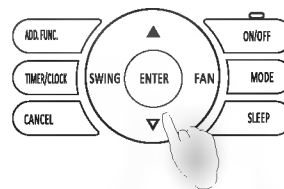

2. Wired Controller(YXE-C01U1(E))

Auxiliary Electric Heating

Under ON conditions or under OFF conditions where TIMER ON function is enabled, and when the air conditioner is in heating mode, press "ADD. FUNC." button to manually select the auxiliary electric heating functions.

When the auxiliary electric heating function is set to ON, the icon  will be on, and it will either display or disappear according to the actual state after 5 minutes (electric heater may not turn on as the internal control condition is not satisfied).

When the auxiliary electric heating function is set to OFF, the icon  will disappear, and the electric heating function will be turned off immediately.

NOTE:

1. This function is only available for air conditioners with auxiliary electric heater, and only can be selected in heating mode.
2. If you do not manually set the auxiliary heating function, this function will automatically start or cancel as per the external environment temperature and other conditions by default.
3. The manual auxiliary heating setting will be cancelled after the operations such as mode switch, outage, ON/OFF, etc.

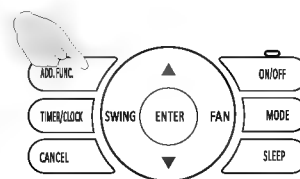

Sleep Mode

With the sleep function, the air conditioner will run in the mode of comfortable sleep to improve comfort.

How to activate:

Press the "SLEEP" button when the appliance is on to set the sleep function. The icon  will be displayed on the LCD, indicating that sleep mode is activated.

How to cancel:

Press the "SLEEP" button again to cancel the sleep function. The icon  will disappear from LCD, indicating that sleep mode has been cancelled.

KNOWLEDGE:

If you want to change the OFF time during SLEEP mode, please set "TIMER OFF" in addition, for detailed operation, please refer to "TIMER OFF" setting.

NOTE:

The sleep function is not applicable in the FAN ONLY mode and AUTO mode.

For some types of air conditioners, the set temperature value on display in sleep mode may not change along with the changing of set temperature.

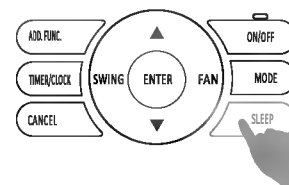

2. Wired Controller(YXE-C01U1(E))

Button Locked

After the wired controller setting is completed, lock buttons to avoid wrong operation by children and others. All operations are disabled after button lock function has been set.

How to activate:

Press and hold "ENTER" button for 3s to activate button lock function, and icon  will display on the LCD.

How to cancel:

Press and hold "ENTER" button for 3s again to unlock, and icon  will disappear from the LCD.

NOTE:

For button locked by the next higher command of central controller, it cannot be cancelled, and only be unlocked by the central controller.

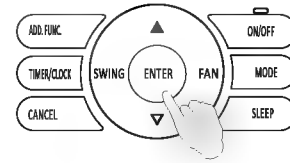

Clock Setting

In case of any clock loss due to first startup and long-time shutdown, it is required to set the clock.

Setting method:

1. After startup, all indicators for days of the week and for the clock on the display screen flicker.
2. Press the "▲" and "▼" buttons to respectively adjust the set values of days of the week, hours, and minutes.
3. Press the "ENTER" button to confirm the setting, the indicators for days of the week, hours, and minutes stop flickering, then the setting is completed.

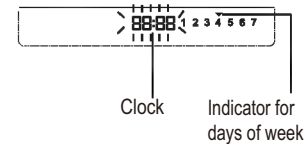

NOTE:

Pressing and holding down the "▲ / ▼" button causes the value to increase continuously and rapidly.

Clock Correction

When the clock value is not consistent with the standard time, the clock shall be corrected.

Setting Method:

Hold down the "ON/OFF" button for 3s, then the wired controller will be shut down, and hold down the "TIMER/CLOCK" button for 3s again, it will go into the clock correction mode.

Adjust the clock in the following sequence:



1. First, the cursor right above days of week will flicker, and then you can press the "▲" (plus button) and "▼" (minus button) to adjust the date to the required one, e.g., Thursday **1 2 3 4 5 6 7**, and press the "ENTER" button to confirm the settings.
2. Next, the hours setting icon **88:** will flicker in succession, then you can press the "▲" (plus button) and "▼" (minus button) to adjust the hour to the required one, and press the "ENTER" button to confirm the settings.
3. At last, it proceeds to minutes setting in sequence (the setting method is the same to that for hours).

The icons will stop flickering after the clock correction setting is completed.

NOTE:

Pressing and holding down the "▲ / ▼" button causes the value to increase continuously and rapidly.

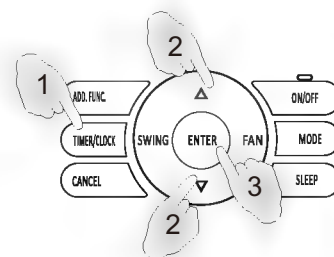

2. Wired Controller(YXE-C01U1(E))

Single Timer ON (Invalid under weekly timer setting)

How to activate:

- 1 Press "TIMER/CLOCK" button during OFF condition, icon  and Timer ON indicator "ON" displays on LCD, "ON" and timer hour setting flicker.
- 2 Press "▲" (plus button) and "▼" (minus button) button to adjust the time.
Each time "▲" button is pressed, time setting increases by 1h.
Each time "▼" button is pressed, time setting decreases by 1h.
It can be set from 1h to 24h, and time setting resolution is 1 hour.
- 3 Press "ENTER" button when the desired time is reached.
After operation, the display will be back to the previous display before Timer ON setting, and "Timer" indicator appears on the left corner of the screen.

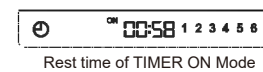
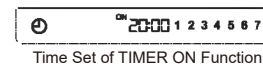
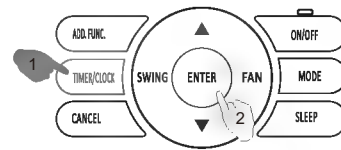

You can press the "CANCEL" button at any time to cancel the Timer ON setting and exit.

You can press the "TIMER/CLOCK" button to cancel the current setting and exit.

Press "TIMER/CLOCK" button again after TIMER ON has been set to display the rest of the time.

Simple TIMER ON Inquiry

Press "TIMER" button again after TIMER ON has been set to display the rest of the time.

As shown in the figure, it indicates that the appliance will be started after 58 minutes.

30s without any operation will quit query.

Single Timer OFF (Invalid under weekly timer setting)

Operation:

- 1 Press TIMER button when the appliance is on, icon  and Timer OFF indicator "OFF" display on LCD, "OFF" and timer hour setting flicker.
- 2 Press "▲" (plus button) and "▼" (minus button) button to adjust the time.
Each time "▲" button is pressed, time setting increases by 1h.
Each time "▼" button is pressed, time setting decreases by 1h.
It can be set from 1h to 24h, and time setting resolution is 1 hour.
- 3 Press "ENTER" button when the desired time is reached.
After operation, the display will be back to previous display before Timer OFF setting, and "Timer" indicator appears on the left corner of the screen.

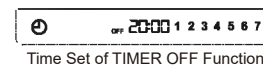
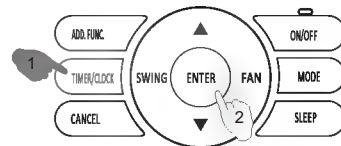

You can press the "CANCEL" button at any time to cancel the Timer OFF setting and exit.

You can press the "TIMER/CLOCK" button to cancel the current setting and exit.

Simple TIMER OFF Inquiry

Press "TIMER/CLOCK" button again after TIMER OFF has been set to display the rest of the time.

As shown in the figure, it indicates that the appliance will be turned off after 58 minutes.

30s without any operation will quit query.

NOTE:

The TIMER ON/OFF functions can not be set at the same time, if you need TIMER ON/OFF work in the future time, please use WEEKLY TIMER function.

Pressing and holding down the "▲ / ▼" button causes the value to increase continuously and rapidly.

2. Wired Controller(YXE-C01U1(E))

Weekly Schedule

Weekly timer can be used to set ON/OFF time respectively for seven days a week. Air conditioner can be on/off at preset time every day, without manual control. The air conditioner can be on/off automatically before you wake up in the morning, back home from work or during sleep at night. Weekly timer ON/OFF time can be set for four groups at most, and the four groups can be assigned to any day regularly.

NOTE:

Please set the clock correctly before weekly timer setting.

Operation Procedure

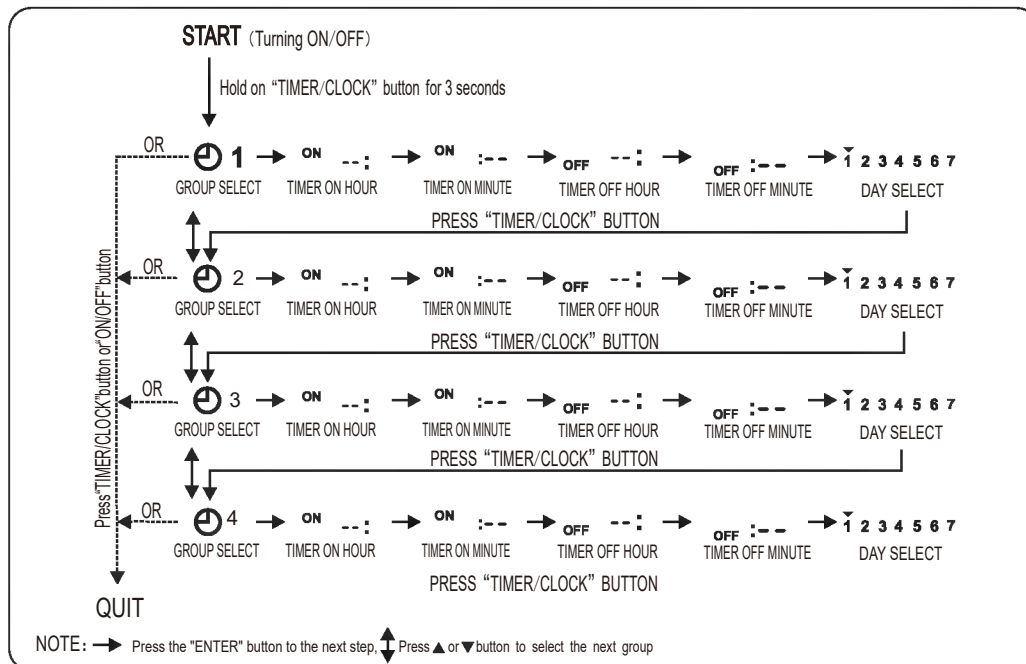

Weekly Timer Setting Procedure

OPERATION:

1. Press "TIMER/CLOCK" button for 3 seconds to activate weekly timer setting, icon appears on the LCD, and group number starts flickering.

Follow the sequence below to the next setting:



When the first timer group number 1 blinks, press "ENTER" button to enter Timer ON setting.

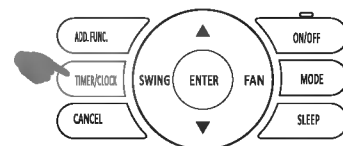

2. Wired Controller(YXE-C01U1(E))

- Timer ON hour flickers, press “▲”(plus button) or “▼” (minus button) to select the desired time.
Each time “▲” button is pressed, time increases by 1h;
Each time “▼” button is pressed, time decreases by 1h.
Pressing and holding down the “▲/▼” button causes the value to increase continuously and rapidly.
After timer ON hour has been set, press “ENTER” button to return to timer ON minute setting.
If you don't need Timer OFF setting, press “CANCEL” button to cancel it.
- Timer OFF setting is the same step with timer ON setting.
- After TIMER ON/OFF setting is completed, press “▲” (plus button)/ “▼” (minus button) to select desired day, press “ENTER” button to confirm it, or press “CANCEL” button to cancel it. The selected day will be marked with “.”.
For example, **1 2 3 4 5 6 7** shows any day of a week selected is effective.
- Continue group 2 setting, repeat the same setting procedure as group1. Four groups Timer ON/OFF can be set at most .
- You can quit WEEKLY TIMER setting by pressing “TIMER/CLOCK” or “ON/OFF” button when group number is flickering.

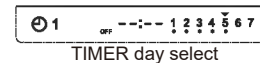
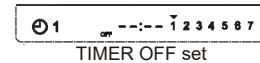
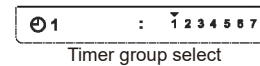

Weekly Timing Inquiry

When the weekly TIMER function is available, it will go into the weekly timing inquiry if you press the “TIMER/CLOCK” button. Press the plus button “▲” or minus button “▼” to inquire the previous or the next timer moment.

NOTE:

If you need to temporarily leave for a few days when weekly timer has been set, meanwhile timer ON/OFF is not permitted to work and continue to work after you are back, you can hold down “ON/OFF” button for 3 seconds to turn it off completely. At this moment, set time of the weekly timer can still be saved, but the air conditioner will not run. Weekly timer setting resolution is 1 minute. Timer ON/OFF signal is effective within 1 minute.

Buzzer Indicator Selection

The buzzer beeps by default when the controller is operated. If you need mute operation, hold down “FAN” button for 3 seconds, the buzzer beeps for 4 times indicating the setting has been successfully changed. Repeat the same steps to return to the original setting.

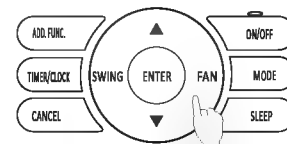

Dimmer Setting

The screen is bright by default. If you want the screen to be dark, hold down “MODE” button for 3 seconds, the buzzer beeps for 4 times indicating the setting has been successfully changed. Repeat the steps above to return to the original setting.

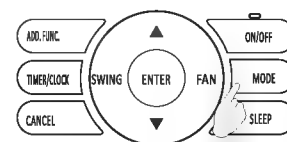

2. Wired Controller(YXE-C01U1(E))

Filter Cleaning Resetting

(Available for models equipped with filter cleaning function and it needs to be operated by professional staff)

When  displays on LCD, it indicates that the filter needs to be cleaned.

Please contact the professional staff to do filter cleaning. After cleaning, hold down "CANCEL" button for 3 seconds to reset the warning prompt.

NOTE:

FILER CLEANING screen prompt is only effective for specific models.

For details, please refer to indoor unit manuals. Be sure to stop the operation and disconnect the power supply before performing any cleaning.

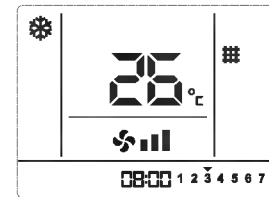

Maintenance

- Wipe the LCD and other surface part of the remote controller with a dry cloth when they become dirty.
- If the dirt on the surface cannot be removed, soak the cloth in neutral detergent diluted with water, squeeze the cloth tightly, and clean the surface. Wipe the surface with a dry cloth then.
- Do not use any thinner, organic solvents, or strong acid.

Troubleshooting

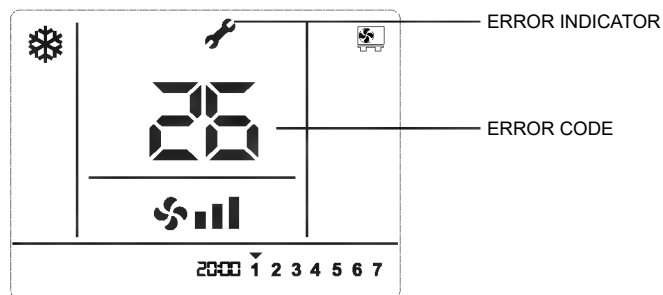

When the air conditioner malfunctions,  will be displayed on the LCD, indicating that error is occurring, please consult your local dealer or after-sales service.

2. Wired Controller(YXE-C01U1(E))





2.2.2 Installation Manual

1 Safety Precautions

Be sure to read safety precautions in the wired remote controller operation manual carefully before installation, and install it correctly.

2 Checking Accessories

Check the following accessories are included with the unit before installation:

Installation Manual	Operation Manual	Wood Screw	Tapping Screw	Connection Cord
				
(1pc)	(1pc)	(2 pc)	(2 pc)	(1 pc)

3 How to Install

1. Selecting the Installation Location.

Please select the installation location according to **safety precautions** in the operation manual.

2. Preparing a hole through the wall to pass the wired controller cord.

(If the wires are taken out from the back side.)

Unit: inch(mm)

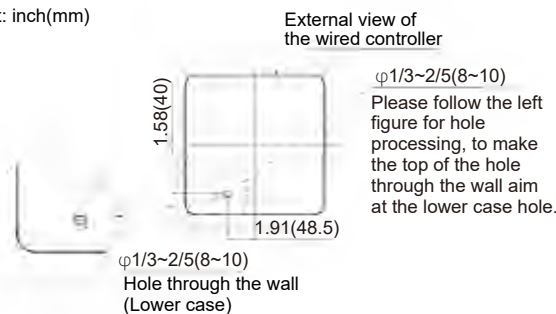

NOTE:

If the hole is too large or deviated from specified location, it may be exposed.

3. Removing the upper case of the wired controller.

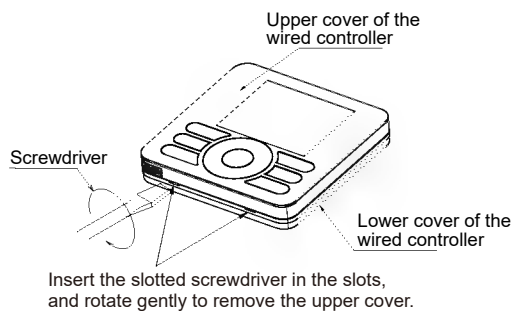

NOTE:

Control board of the wired controller is placed on the upper cover, please protect it from being scratched during removal and installation!

4. Passing the wired controller cord out of the lower case. There are two ways to pass the remote controller cord out, please select it according to the actual situation.

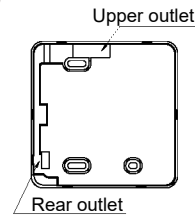

5. Connecting the remote controller cord to the terminal block.

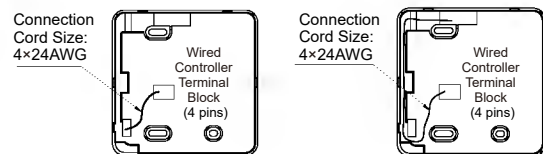

Connect the wired controller terminal block with the indoor terminal block by the connection cord. For details, please refer to the indoor wiring diagram.

NOTE: Please fasten the cord after connection.

In order to prevent water, insects, etc. going into the wire outlet, please seal the entrance with putty (filed-supplied).

6. Lower Case Fixing

① For Direct Installation on the Wall

Please fix the lower case with wood screws (2pcs) in accessories.

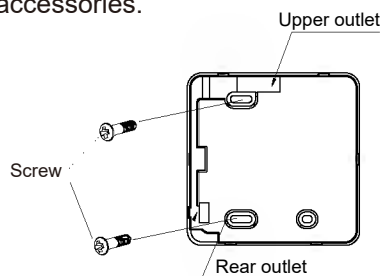

② For Installation on the Switch Box

Please fix the lower case with tapping screws (2pcs) in accessories.

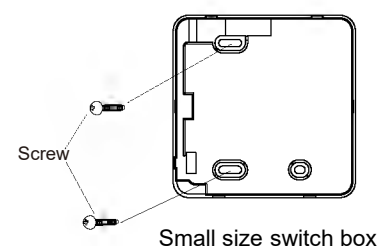
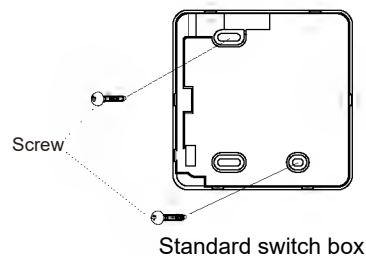

2. Wired Controller(YXE-C01U1(E))

4 Well Mounting the Upper Cover

Align the upper cover with the hasp of the lower cover of the wired remote controller, then press the upper cover onto the lower cover. After installation, tear off the protective sticker attached on the display of the wired controller.

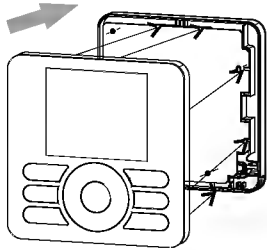

2. Wired Controller(YXE-C01U1(E))

2.2.3 Checking and Setting

Indoor Unit Parameter Checking

The internal parameters of the air conditioner can be read with the following method.

Instruction

1. Hold down Mode button and ADD. FUNC. button for 3s simultaneously to enter parameters customer-reading state, then customer-reading parameter codes will display in temperature display area. (See fig.1)

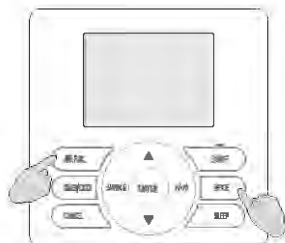

fig.1

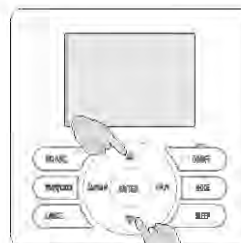

fig.2

2. Press Up or Down button to adjust to the customer-reading parameter code to read. For detailed information, please refer to Table 1. For example, the picture below means that it is a duct indoor unit. (See fig.2)

Table 1

Customer-reading Parameter Code	Implication of Code Display	Description
01	Indoor unit kind	00H: Wall mounted; 01H: Ducted; 02H: Cassette; 03H: Ceiling & Floor; 04H: Floor Standing; 05H: ATW;
06	IDU environment temperature	°C
07	IDU coil temperature	°C
08	ODU environment temperature	°C
09	Discharge temperatur	°C
11	ODU coil temperature	°C
14	EEV step	
23	I feel temperature by wired controller	°C
24	Error code	
25	Sub-error code of driving board error E45	

3. Press ON/OFF button to quit customer-reading state. (See fig.3)

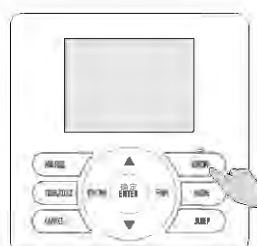



fig.3

2. Wired Controller(YXE-C01U1(E))

Indoor Unit Parameter Setting

The internal parameters of the air conditioner can be set with the following method.

Instruction

1. Hold down both MODE button and ADD. FUNC. button for 3s, symbol  and parameter number blink at the same time. (See fig.4)

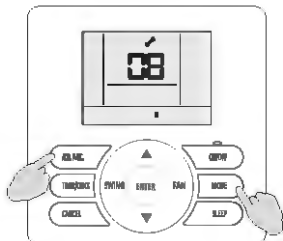

fig.4

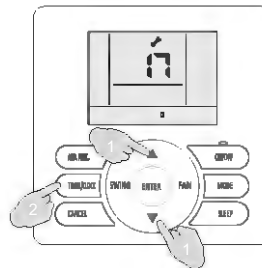









fig.5

2. Press  or , and the parameter code increases or decreases by 1 accordingly. When 17 displays, press ENTER button to rewrite the EE parameter of the indoor unit, at the same time, the symbol  lights and EE parameter code 00 blinks.(See fig.5)
3. Press  or , and the EE parameter code increases or decreases by 1 accordingly and the corresponding value of EE displays in the Timer display area. When the EE code needs to be rewritten displays, press ENTER button to come to EE rewriting mode, at the same time the symbol  lights, EE parameter code lights and the value of EE blinks. For the EE parameter code, see Table 2.
4. When the value of EE blinks, press  or  to adjust it until the value needed displays, at this time, press TIMER/CLOCK button to save it. For example, the diagram above shows that when the parameter code is 1 (Self-recovery of power break), the function of self-recovery of power break can be realized.
5. Press ON/OFF button to quit to # 17, press ON/OFF button again to exit from the parameter rewriting state.

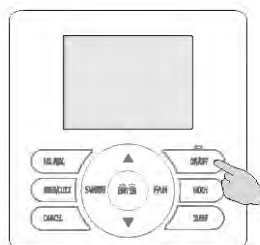

fig.5

2. Wired Controller(YXE-C01U1(E))

Table 2

Parameter Code	Parameter Description	Parameter Value&Representation		NOTE
		Data Type	Representation (Function Code)	
1	Self recovery of power break	Integer	0: Cancel self recovery of power break function; 1: Self recovery of power break; others: invalid.	
2	Temperature type	Integer	0: Centigrade temperature; 1: Fahrenheit temperature; others: invalid.	
3	Temperature display type	Integer	0: Default display set temperature; 1: Default display room temperature; others: invalid.	
4	Ratio of ambient temperature sensed by indoor temperature sensor(cooling mode)	Integer	0~10valid, more than 10default is 10 0:0%; 1:10%;...; 10:100%	0:entirely use temperature sensed by wired remote controller; 10:entirely use temperature sensed by indoor unit
5	Filter clean indication	Integer	0: Default display set temperature 1: Default display room temperature others: invalid	
6	Filter clean time set	Integer	0~32, more than 32 default is 32*1000h	
7	Installation height compensation	Integer	0~10m, more than 10m default is 10. =0,1,2: no fan speed compensation =3: increase fan speed =4~10: increase more fan speed	
8	Cooling temperature compensation(indoor unit temperature sensor)	Integer	0: 0°C;1:-0.5°C;2:-1°C;3:-1.5°C;4:-2°C; 5:-2.5°C;6:-3.0°C;7:-3.5°C;8:-4°C;9:-4.5°C; 10:-5°C (the wired controller displays integer with symbol)	
9	Heating temperature compensation(indoor unit temperature sensor)	Integer	0: 0°C;1:-0.5°C;2:-1°C;3:-1.5°C;4:-2°C; 5:-2.5°C;6:-3.0°C;7:-3.5°C;8:-4°C;9:-4.5°C; 10:-5°C (the wired controller displays integer with symbol)	
10	Static pressure set	Integer	1~250, function code=static pressure more than the limit static pressure default the limit static pressure, default is 0 (default static pressure, related to models)	Duct type(DC motor)
12	Ratio of temperature sensed by indoor temperature sensor(heating mode)	Integer	0~10valid, more than 10 default is 10 0:0%; 1:10%;...; 10:100%	0:entirely use temperature sensed by wired remote controller; 10:entirely use temperature sensed by indoor unit
13	Temperature adjustment-cooling	Character	-10~10°C (single character with symbol)	Temperature displayed on wired controller
14	Temperature adjustment-heating	Character	-10~10°C (single character with symbol)	Temperature displayed on wired controller
25	Access control, fire protection, ON/OFF function set	Integer	=0, access control, fire protection functions are all invalid; =1, access control function is valid; =2, fire protection function is valid; =3, access control, fire protection are all valid; =4, ON/OFF function are all valid.	

2. Wired Controller(YXE-C01U1(E))

Self-setting Parameters

The internal parameters of the wired controller can be set with the actual usage conditions.

The catalogue of custom-setting parameters is shown as follows:

Custom-setting Parameter Code	Implication of Code Display	Description	Remarks
01	Version No.		
03	boot	Restore factory default	
05	Is remote control/button operation setting permitted or not	0-Remote control/button permitted; 1-Reserved; 2-Button prohibited; 3-Remote control/button prohibited see the table3 on the right for more content	The factory setting defaults to 0
06	Temperature display setting	0-Display the set temperature; 1-Display the indoor room temperature	
07	Temperature measurement unit display setting	0-Display in Celsius; 1-Display in Fahrenheit degree	
08	Cooling-only setting	0-Heat pump type air conditioner; 1-Cooling-only air conditioner	
10	Temperature limits revision setting	0-Prohibited; 1-Permitted	
11	Room temperature revision setting	0-Prohibited; 1-Permitted	

Table 3

NO	Description
0	Remote control/button permitted
1	Remote control prohibited
2	Button prohibited
3	Remote control/button prohibited
5	Turning ON/OFF by remote control prohibited
13	Turning on by remote control & MODE setting prohibited
17	Temperature setting by remote control prohibited
21	Temperature setting by remote control prohibited & ON/OFF setting prohibited
25	Temperature setting by remote control prohibited & MODE setting prohibited
29	Temperature setting by remote control prohibited & MODE setting & ON/OFF setting prohibited
33	Fan speed setting prohibited
37	Fan speed & ON/OFF setting prohibited
41	Fan speed & MODE setting prohibited
45	Fan speed & MODE & ON/OFF setting prohibited
49	Fan speed & temperature setting prohibited
53	Fan speed & temperature & ON/OFF setting prohibited
57	Fan speed & temperature & MODE setting prohibited
61	Fan speed & temperature & MODE & ON/OFF setting prohibited
65	Swing setting prohibited
69	Swing & ON/OFF setting prohibited
73	Swing & MODE setting prohibited
77	Swing & MODE & ON/OFF setting prohibited
81	Swing & temperature setting prohibited
85	Swing & temperature & ON/OFF setting prohibited
89	Swing & temperature & MODE setting prohibited
93	Swing & temperature & MODE & ON/OFF setting prohibited
97	Fan speed & swing setting prohibited
101	Fan speed & swing & ON/OFF setting prohibited
105	Fan speed & swing & MODE setting prohibited
109	Fan speed & swing & ON/OFF & MODE setting prohibited
113	Fan speed & swing & temperature setting prohibited
117	Fan speed & swing & temperature & ON/OFF setting prohibited
121	Fan speed & swing & temperature & MODE setting prohibited
125	Fan speed & swing & temperature & ON/OFF & MODE setting prohibited

The Method of Setting the Custom Parameters

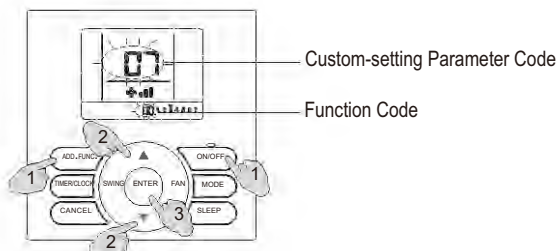

1. Press and hold "ADD. FUNC." and "ON/OFF" buttons at the same time for 3s, to access the custom-setting mode, and the custom-setting parameter code will flicker on the screen.
2. Press the "▲" button (plus) or "▼" button (minus) to select the custom-setting parameter code that is required to be set, and press the "ENTER" button, with the function code displayed flickering.
3. Press the "▲" (plus) button or "▼" (minus) button to select the function code, and press "ENTER" button to confirm the setting.

How to exit:

Press "Cancel" button to exit when any custom-setting code is displayed.

Parameter Setting

When the wired controller is set to display the room temperature, the temperature setting limit can be revised if needed. Before setting, please check if these parameters are enabled to be revised. For details, see **Custom-setting parameters**.

2. Wired Controller(YXE-C01U1(E))

1. Room Temperature Correction

Setting of room temperature correction is for particular cases (e.g. installation location is near a marble wall): when the wired controller is set to display the room temperature, but the room temperature detected is different from the actual one, so setting correction is necessary.

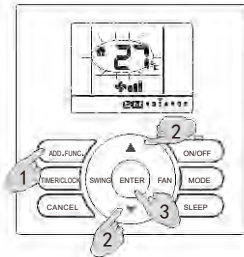

Room Temperature Correction

Setting Method:

1. Under OFF conditions, press the “▲” or “▼” button to display the 🏠 icon.
2. Hold down the “ADD.FUNC” for 3s, the buzzer will beep for four times to alert that it goes into the room temperature modification state. The room temperature value and icon 🏠 start flickering at the same time.
3. Press the “▲” (plus) button or “▼” (minus) button to select the room temperature value within an offset of $\pm 10^{\circ}\text{F}/^{\circ}\text{C}$ of the current temperature, press the “ENTER” button to confirm the setting, save the setting and exit.

How to cancel:

In room temperature correction mode, press “CANCEL” button to cancel correction and exit.

Press any other button (except MODE button) to exit from room temperature correction directly.

2. Temperature Limit Setting

Default temperature range is $(61-86)^{\circ}\text{F}$ [$(16-30)^{\circ}\text{C}$]. You can change the range when needed.

For example, in cooling mode, temperature adjustment range could be changed to $(73-86)^{\circ}\text{F}$ [$(23-30)^{\circ}\text{C}$]; in heating mode, it could be changed to $(61-73)^{\circ}\text{F}$ [$(16-23)^{\circ}\text{C}$]. The temperature limit is only effective for the cooling and heating modes.

Setting method:

1. Under OFF conditions, press down the “▲” (plus button) or “▼” (minus button) to adjust the wired remote controller to display 🌡️.
2. Hold down the “ADD. FUNC.” button for 3s, and the buzzer will beep for four times to alert that it goes into the set temperature limit state. The wired remote controller's limit temperature value and icon will flicker.
3. Press the “▲” button (plus) or “▼” button (minus) to adjust the temperature limit value

within the range of $(61-86)^{\circ}\text{F}$ [$(16-30)^{\circ}\text{C}$], and if you press the “MODE” button, it will change in the following sequence:



Press “ENTER” button to save the change and exit. After setting, the limit temperature icon and numerical value icons stop flickering.

2. Wired Controller(YXE-C02U1(E))

2.3 YXE-C02U1(E)

2.3.1 Function Introduction

Part Names

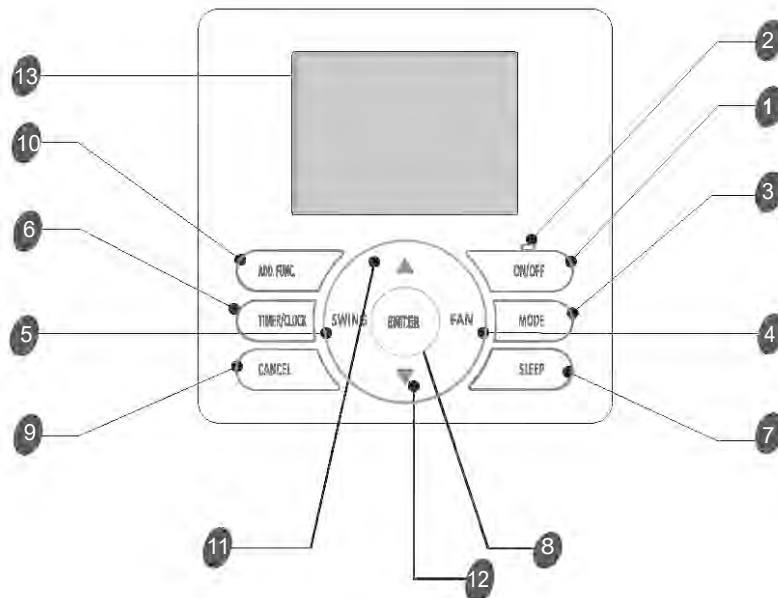

- 1 ON/OFF BUTTON**
The appliance will be started or stopped when this button is pressed.
- 2 RUN INDICATOR**
Indicates that the appliance is on.
- 3 MODE BUTTON**
Press this button to select the operation mode.
- 4 FAN BUTTON**
Used to select fan speed in sequence high-auto-low-medium-high.
- 5 SWING BUTTON (Invalid for some models)**
Used to stop or start adjustment louver swinging and set the desired airflow direction.
- 6 TIMER/CLOCK BUTTON**
Used to set the current time or set timer ON/OFF.
- 7 SLEEP BUTTON**
Used to set or cancel Sleep Mode operation.
- 8 ENTER BUTTON**
Used to confirm settings.
- 9 CANCEL BUTTON**
Used to cancel settings.
- 10 ADD.FUNC. BUTTON (Invalid for some models)**
Used to set filter cleaning, hot water, fresh air, electric heater, etc.
- 11 INCREASE SETTING BUTTON**
Used to raise the set temperature;
It raise the values when setting.
- 12 DECREASE SETTING BUTTON**
Used to lower the set temperature;
It lower the values when setting.
- 13 LIQUID CRYSTAL DISPLAY(LCD) SCREEN**
Used to display indicator screens.

2. Wired Controller(YXE-C02U1(E))

LCD Screen

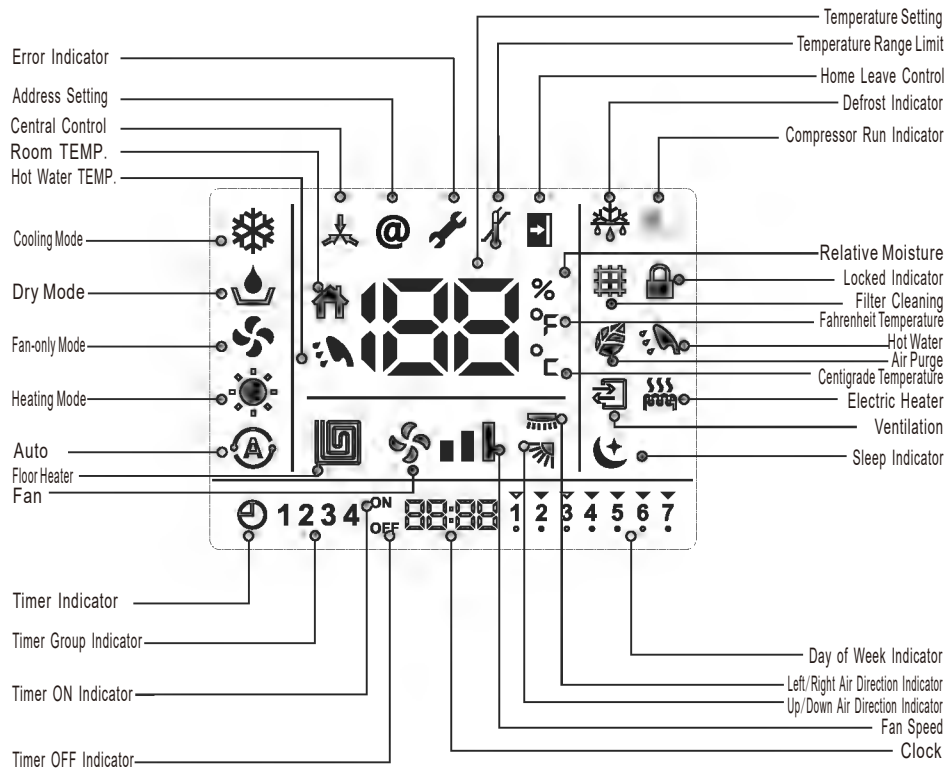

NOTE:

1. For purpose of explanation, all parts of the display are shown. During actual operation, only the relevant items will be displayed.
2. Heating and electric heating function are not available for cooling only models.
3. Air direction, Filter Cleaning, Hot Water, Floor Heat, Ventilation, Electric Heating etc. are only effective for dedicated models. For details, please refer to operation manual.
4. ERROR and Maintenance, Address Setting, Central Control, TEMP. Range Limit, Fahrenheit Temperature should be set by the dealer.

2. Wired Controller(YXE-C02U1(E))

Simple Operation

This wired remote controller should be used with the air conditioner, and it can be used for cooling, heating, drying and fan, etc. For other functions and settings, please refer to the specific operation in this manual.

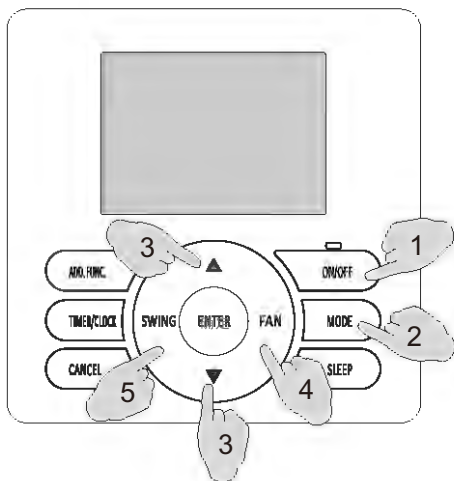

1. Turning ON/OFF

<To start operation>

Press the ON/OFF button, the ON lamp lights up, and the appliance will be started.

<To Stop Operation>

Press the ON/OFF button again, the ON lamp goes off, and the appliance will be stopped.

Hold down "ON/OFF" button for more than 3 seconds, the appliance will enter completely shutdown state.

(When the indoor unit stops, you cannot use Timer ON to start, but start it manually), the buzzer beeps for 4 times.

NOTE:

After receiving Turn OFF command from the central controller, the remote controller will enter completely shutdown state.

2. Mode Setting

Press "MODE" button to select mode.

Each time MODE button is pressed, the operation mode changes in the sequence below:



NOTE:

AUTO mode is invalid for models without AUTO mode when setting.

HEATING mode is invalid for cooling only types or heating-forbidden air conditioners.

3. Temperature Setting

Under the ON conditions or under the OFF conditions where TIMER ON function is enabled.

Press "▲" or "▼" button to enter the temperature setting state.

Each time "▲" button is pressed, temperature setting rises by 1°F/1°C;

Each time "▼" button is pressed, temperature setting lowers by 1°F/1°C;

Range of Temperature Setting	
HEATING, COOLING, DRY, AUTO	61°F~86°F(16°C~30°C)
FAN ONLY	Unavailable for setting

NOTE:

1) Heating mode is ineffective for COOLING ONLY models.

2) The default setting range depends on the indoor unit.

3)The set range can be changed by professional stuff, please contact installation service when needed.

4) When the set temperature is above the set range, will display on the LCD, and the set temperature will not rise or lower any more.

4. Fan Speed Setting

Under ON conditions or under OFF conditions where TIMER ON function is enabled, press the "FAN" button to adjust the fan speed. The fan speed will change in the following sequence:





2. Wired Controller(YXE-C02U1(E))

5. Airflow Direction Setting

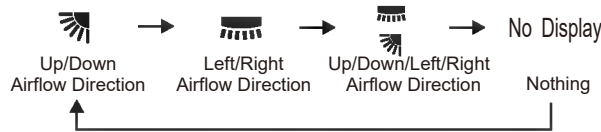
Under ON conditions or under OFF conditions where TIMER ON function is enabled, press the “SWING” buttons to adjust the airflow direction. The airflow direction setting will change in the following sequence by default:



NOTE:

1. This setting is only effective for units with this swing function.
2.   is only available for specific models.

6. Receiving Command from the Central Controller

Under any conditions, after receiving the command from central controller the integrated control icon  will be on, and the machine will run in line with the command of the central controller. The later command from the central controller or remote controller has the prior order.

Function Setting

Super Mode

The maximum cooling/heating capacity can be activated in the super mode.

How to activate:

Press the “▲” buttons for 3s under ON conditions to activate the super mode, and the indoor unit will run at the ultrahigh fan speed, and icon  will flicker on the display.

If you operate the Super mode in COOLING, DRY and FAN ONLY modes, the unit will automatically go into forced cooling mode with the lowest set temperature, or go into forced heating mode with the highest set temperature in heating mode.

How to cancel:

Press “ON/OFF”/“MODE”/“SLEEP”/“FAN” button to exit immediately.

NOTE:

For the indoor units without ultrahigh fan speed function, it will be adjusted to run at high fan speed in Super mode, with high fan speed mode icon  displayed.

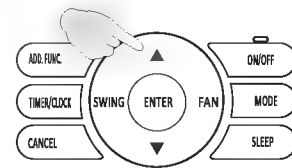

Silence Mode

The silence running mode reduces the noise by changing the fan speed of indoor unit so as to keep quiet during operation at night.

How to activate:

In COOLING/HEATING mode during appliance operation, press the “▼” button for 3s to activate silence mode, the indoor unit will run at the ultralow fan speed, and icon  will flicker on the display.

How to cancel:

Press “ON/OFF”/“MODE”/“SLEEP”/“FAN” button to exit.

NOTE:

For the indoor units without ultralow fan speed function, it will be adjusted to run at low fan speed in Silence mode, with low fan speed mode icon  displayed.

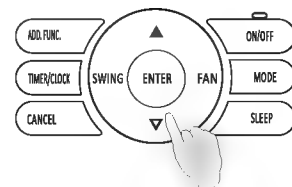

2. Wired Controller(YXE-C02U1(E))

Auxiliary Electric Heating

Under ON conditions or under OFF conditions where TIMER ON function is enabled, or when the air conditioner is in heating mode, press “ADD. FUNC.” button to manually select the auxiliary electric heating functions.

When the auxiliary electric heating function is set to ON, the icon  will be on, and it will either display or disappear according to the actual state after 5 minutes (electric heater may not turn on as the internal control condition is not satisfied).

When the auxiliary electric heating function is set to OFF, the icon  will disappear, and the electric heating function will be turned off immediately.

NOTE:

1. This function is only available for air conditioners with auxiliary electric heater, and only can be selected in heating mode.
2. If you do not manually set the auxiliary heating function, this function will automatically start or cancel as per the external environment temperature and other conditions by default.
3. The manual auxiliary heating setting will be cancelled after the operations such as mode switch, outage, ON/OFF, etc.

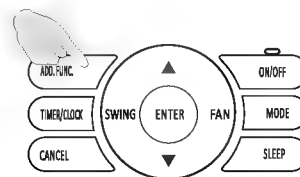

Sleep Mode

With the sleep function, the air conditioner will run in the mode of comfortable sleep to improve comfort.

How to activate:

Press the “SLEEP” button when the appliance is on to set the sleep function. The icon  will be displayed on the LCD, indicating that sleep mode is activated.

How to cancel:

Press the “SLEEP” button again to cancel sleep function. The icon  will disappear from LCD, indicating that sleep mode has been cancelled.

KNOWLEDGE:

If you want to change the OFF time during SLEEP mode, please set “TIMER OFF” in addition, for detailed operation, please refer to “TIMER OFF” setting.

NOTE:

The sleep function is not applicable in the FAN ONLY mode and AUTO mode.

For some types of air conditioners, the set temperature value on display in sleep mode may not change along with the changing of set temperature.

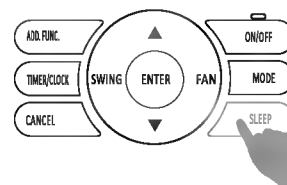

2. Wired Controller(YXE-C02U1(E))

Button Locked

After the wired controller setting is completed, lock buttons to avoid wrong operation by children and others. All operations are disabled after button lock function has been set.

How to activate:

Press and hold "ENTER" button for 3s to activate button lock function, and icon  will be displayed on the LCD.

How to cancel:

Press and hold "ENTER" button for 3s again to unlock, and icon  will disappear from the LCD.

NOTE:

For button locked by the next higher command of central controller, it cannot be cancelled, and only be unlocked by the central controller.

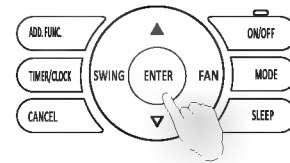

Clock Setting

In case of any clock loss due to first startup and long-time shutdown, it is required to set the clock.

Setting method:

1. After startup, all indicators for days of the week and for the clock on the display screen flicker.
2. Press the "▲" and "▼" buttons to respectively adjust the set values of days of the week, hours, and minutes.
3. Press the "ENTER" button to confirm the setting, the indicators for days of the week, hours, and minutes stop flickering, then the setting is completed.

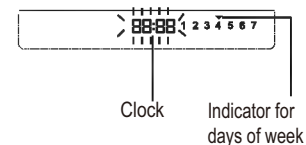

NOTE:

Pressing and holding down the "▲/▼" button causes the value to increase continuously and rapidly.

Clock Correction

When the clock value is not consistent with the standard time, the clock shall be corrected.

Setting method:

Hold down the "ON/OFF" button for 3s, the wired controller will be shut down, and hold down the "TIMER/CLOCK" button for 3s again, it will go into the clock correction mode.

Adjust the clock in the following sequence:



1. First, the cursor right above days of week will flicker, and then you can press the "▲" (plus button) and "▼" (minus button) to adjust the date to the required one, e.g., Thursday **1 2 3 4 5 6 7**, and press the "ENTER" button to confirm the settings.
2. Next, the hours setting icon **88:** will flicker in succession, and then you can press the "▲" (plus button) and "▼" (minus button) to adjust the hour to the required one, and press the "ENTER" button to confirm the settings.
3. At last, it proceeds to minutes setting in sequence (the setting method is the same to that for hours).

The icons will stop flickering after the clock correction setting is completed.

NOTE:

1. Pressing and holding down the "▲/▼" button causes the value to increase continuously and rapidly.
2. When the wired remote controller is connected to the integrated control network, the clock will automatically keep consistent with the integrated controller.

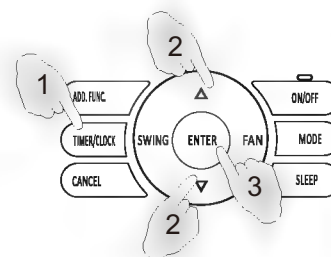

2. Wired Controller(YXE-C02U1(E))

Single Timer ON (Invalid under weekly timer setting)

How to activate:

- 1 Press "TIMER/CLOCK" button during OFF condition, icon  and Timer ON indicator "ON" display on LCD, "ON" and timer hour setting flicker.
- 2 Press "▲" (plus button) and "▼" (minus button) button to adjust the time.
Each time "▲" button is pressed, time setting increases by 1h.
Each time "▼" button is pressed, time setting decreases by 1h.
It can be set from 1h to 24h, and time setting resolution is 1 hour.
- 3 Press "ENTER" button when the desired time is reached.
After operation, the display will be back to previous display before Timer ON setting, and "Timer" indicator appears on the left corner of the screen.

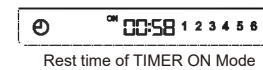
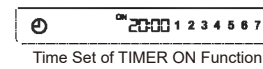
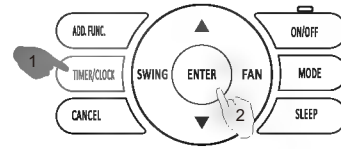

You can press the "CANCEL" button at any time to cancel the Timer ON setting and exit.

You can press the "TIMER/CLOCK" button to cancel the current setting and exit.

Press "TIMER/CLOCK" button again after TIMER ON has been set to display the rest of the time.

Simple TIMER ON inquiry

Press "TIMER" button again after TIMER ON has been set to display the rest of the time.

As shown in the figure, it indicates that the appliance will be started after 58 minutes.

30s without any operation will quit query.

Single Timer OFF (Invalid under weekly timer setting)

Operation:

- 1 Press TIMER button when the appliance is on, icon  and Timer OFF indicator "OFF" displays on LCD, "OFF" and timer hour setting flicker.
- 2 Press "▲" (plus button) and "▼" (minus button) button to adjust the time.
Each time "▲" button is pressed, time setting increases by 1h.
Each time "▼" button is pressed, time setting decreases by 1h.
It can be set from 1h to 24h, and time setting resolution is 1 hour.
- 3 Press "ENTER" button when the desired time is reached.
After operation, the display will be back to previous display before Timer OFF setting, and "Timer" indicator appears on the left corner of the screen.

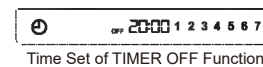
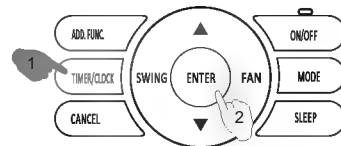

You can press the "CANCEL" button at any time to cancel the Timer OFF setting and exit.

You can press the "TIMER/CLOCK" button to cancel the current setting and exit.

Simple TIMER OFF inquiry

Press "TIMER/CLOCK" button again after TIMER OFF has been set to display the rest of the time.

As shown in the figure, it indicates that the appliance will be turned off after 58 minutes.

30s without any operation will quit query.

NOTE:

The TIMER ON/OFF functions can not be set at the same time, if you need TIMER ON/OFF work in the future time, please use WEEKLY TIMER function.

Pressing and holding down the "▲/▼" button causes the value to increase continuously and rapidly.

2. Wired Controller(YXE-C02U1(E))

Weekly Schedule

Weekly timer can be used to set ON/OFF time respectively for seven days a week. Air conditioner can be on/off at preset time every day, without manual control. The air conditioner can be on/off automatically before you wake up in the morning, back home from work or during sleep at night. Weekly timer ON/OFF time can be set for four groups at most, and the four groups can be assigned to any day regularly.

NOTE:

Please set the clock correctly before weekly timer setting.

Operation Procedure

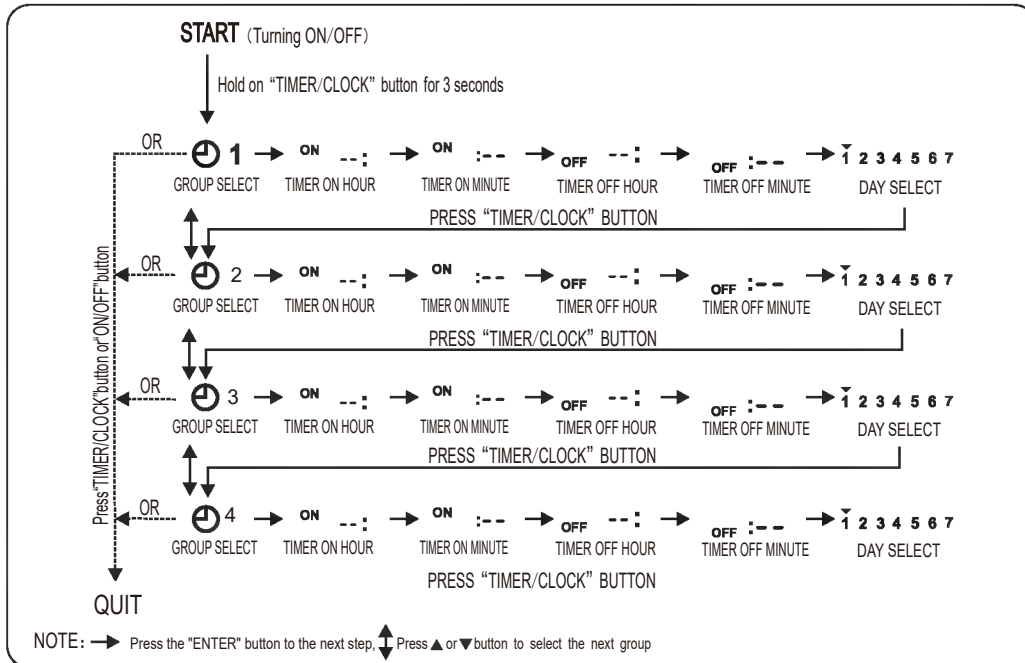

Weekly Timer Setting Procedure

OPERATION:

1. Press "TIMER/CLOCK" button for 3 seconds to activate weekly timer setting, icon appears on the LCD, and group number starts flickering.

Follow the sequence below to the next setting:



When the first timer group number 1 blinks, press "ENTER" button to enter Timer ON setting.

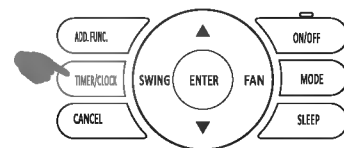

2. Wired Controller(YXE-C02U1(E))

2. Timer ON hour flickers, and press “▲”(plus button) or “▼”(minus button) to select the desired time.

Each time “▲” button is pressed, time increases by 1 hour;
Each time “▼” button is pressed, time decreases by 1 hour.

Pressing and holding down the “▲/▼” button causes the value to increase continuously and rapidly.

After timer ON hour has been set, press “ENTER” button to return to Timer ON minute setting.

If you don't need Timer OFF setting, press “CANCEL” button to cancel.

3. Timer OFF setting is the same step with Timer ON setting.

4. After TIMER ON/OFF setting is completed, press “▲”(plus button)/ “▼”(minus button) to select the desired day, press “ENTER” button to confirm it, or press “CANCEL” button to cancel. The selected day will be marked with “.”.

For example, 1 2 3 4 5 6 7 shows any day of a week selected is effective.

5. Continue group 2 setting, repeat the same setting procedure as group1. Four groups Timer ON/OFF can be set at most .

6. You can quit WEEKLY TIMER setting by pressing “TIMER/CLOCK” or “ON/OFF” button when group number is flickering.

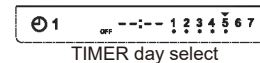
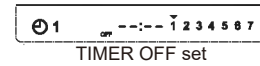
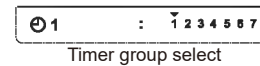

Weekly Timing Inquiry

When the weekly TIMER function is available, it will go into the weekly timing inquiry if you press the “TIMER/CLOCK” button. Press the plus button “▲” or minus button “▼” to inquire the previous or the next timer moment.

NOTE:

If you need to temporarily leave for a few days when weekly timer has been set, meanwhile Timer ON/OFF is not permitted to work and continue to work after you are back, you can hold down “ON/OFF” button for 3 seconds to turn it off completely. At this moment, weekly timer set time can still be saved, but the air conditioner will not run. Weekly timer setting resolution is 1 minute. Timer ON/OFF signal is effective within 1 minute.

Buzzer Indicator Selection

The buzzer beeps by default when the controller is operated.

If you need mute operation, hold down “FAN” button for 3 seconds, the buzzer beeps for 4 times indicating setting has been successfully changed. Repeat the same steps to return to the original setting.

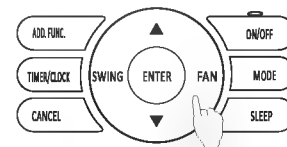

Dimmer Setting

The screen is bright by default. If you need the screen to be dark, hold down “MODE” button for 3 seconds, the buzzer beeps for 4 times indicating setting has been successfully changed.

Repeat the steps above to return to the original setting.

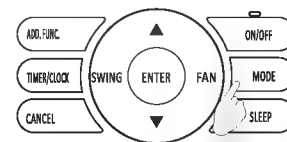

2. Wired Controller(YXE-C02U1(E))

Filter Cleaning Resetting

(Available for models equipped with filter cleaning function and it needs to be operated by professional stuff)

When  displays on LCD, it indicates that the filter needs to be cleaned.

Please contact the professional stuff to do filter cleaning. After cleaning, hold down "CANCEL" button for 3 seconds to reset warning prompt.

NOTE:

FILER CLEANING screen prompt is only effective for specific models.

For details, please refer to indoor unit manuals. Be sure to stop the operation and disconnect the power supply before performing any cleaning.

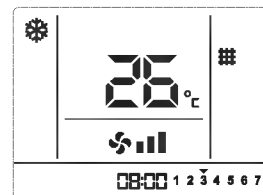

Maintenance

- Wipe the LCD and other surface part of the remote controller with a dry cloth when they become dirty.
- If the dirt on the surface cannot be removed, soak the cloth in neutral detergent diluted with water, squeeze the cloth tightly, and clean the surface. Wipe the surface with a dry cloth then.
- Do not use any thinner, organic solvents, or strong acid.

Troubleshooting

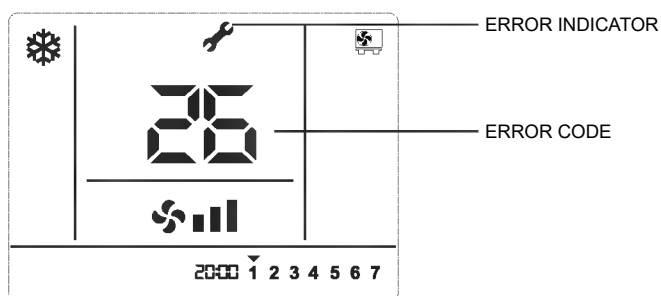

When the air conditioner malfunctions,  will display on the LCD, indicating that error is occurring, please consult your local dealer or after-sales service.

2. Wired Controller(YXE-C02U1(E))





2.3.2 Installation Manual

① Safety Precautions

Be sure to read safety precautions in wired remote controller operation manual carefully before installation, and install it correctly.

② Checking Accessories

Check the following accessories are included with the unit before installation:

Installation Manual	Operation Manual	Self-tapping Screw	Connection Wired
 (1 pc)	 (1 pc)	 (2 pcs)	 (1 pc)

③ How to Install

1. Selecting the Installation Location.
Please select the installation location according to **safety precautions** in operation manual.
2. Removing the upper cover of the wired controller.

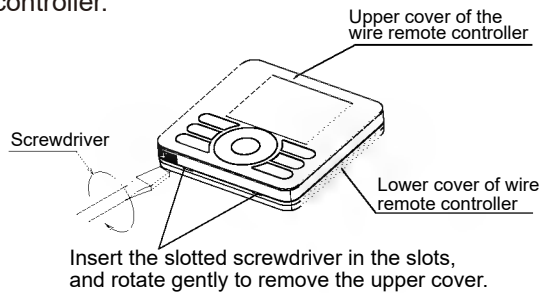

- NOTE:**
Control board of the wired controller is placed on upper cover.
Please protect it from being scratched during removal and installation!

3. Wiring

① Leading out wire

Pull the connection cord of the wired controller and communication line of central controller (if the central control function is necessary) out of the embedded terminal box (to be provided by users) and pass the line out of the rear cover of wired controller for connecting them to the terminal block on the front cover of the wired controller, as shown in the figure below:

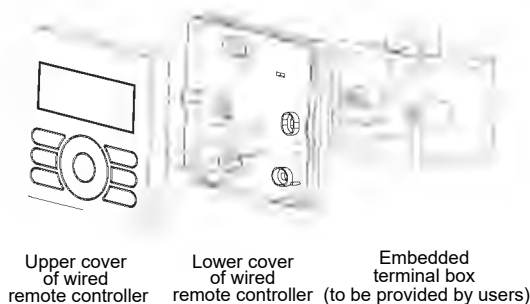

② Wiring

Type of Communication Wire	Min. Specification
Shielded twisted pairs with polarity	Sectional area 2×20AWG(0.75mm ²)

Upper Cover of the Wired Remote Controller



Wired remote controller's connecting wire (connect to indoor unit)

Central controller's communication wire (connect to the integrated controller)

Terminal Block for Central Controller Communication Line

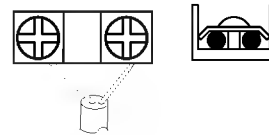

Notes for connection:

- (1) Correct polarity of the communication line should be ensured during connection.
- (2) Loosen the wiring screws, completely insert the ends of the connecting conductor into the terminal block, and tighten the screws. Gently pull the conductor to confirm the connection cord has been tightly screwed.

- ☑ Firmly fasten the connection cord after connection.

4. Securing the lower cover

It is required to be installed onto the embedded terminal box.

Please secure the lower cover with the self-tapping screws (2 pcs) from the attachments.

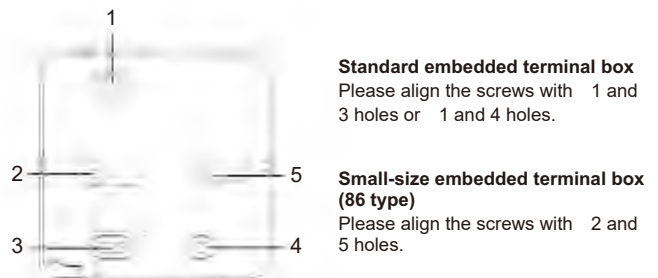

④ Well mounting the upper cover

Align the upper cover with the hasp of lower cover of wired remote controller, then press the upper cover onto the lower cover. After installation, tear off protective sticker attached on the display of the wired controller.

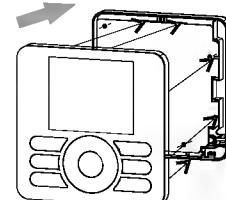

2. Wired Controller(YXE-C02U1(E))

2.3.3 Checking and Setting

Indoor Unit Parameter Checking

The internal parameters of the air conditioner can be read with the following method.

Instruction

1. Hold down Mode button and ADD. FUNC. button for 3s simultaneously to enter parameters customer-reading state, then customer-reading parameter codes will display in the temperature display area. (see fig.1)

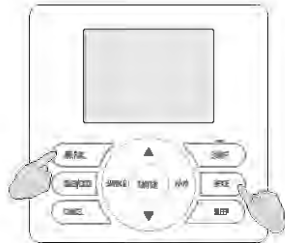

fig.1

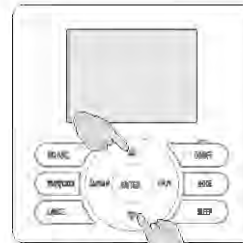

fig.2

2. Press Up or Down button to adjust to the customer-reading parameter code to read. For detailed information, please refer to Table 1. For example, the picture above means that it is a duct indoor unit. (see fig.2)

Table 1

Customer-Reading Parameter Code	Implication of Code Display	Description
01	Indoor unit kind	00H: Wall mounted; 01H: Ducted; 02H: Cassette; 03H: Ceiling & Floor; 04H: Floor Standing; 05H: ATW;
06	IDU environment temperature	°C
07	IDU coil temperature	°C
08	ODU environment temperature	°C
09	Discharge temperatur	°C
11	ODU coil temperature	°C
14	EEV step	
23	I feel temperature by wired controller	°C
24	Error code	
25	Sub-error code of driving board error E45	

3. Press ON/OFF button to quit customer-reading state. (see fig.3)

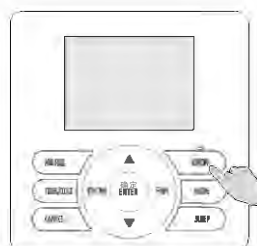



fig.3

2. Wired Controller(YXE-C02U1(E))

Indoor Unit Parameter Setting

The internal parameters of the air conditioner can be set with the following method.

Instruction

1. Hold down both MODE button and ADD. FUNC. button for 3s, symbol  and parameter number blink at the same time. (See fig.4)

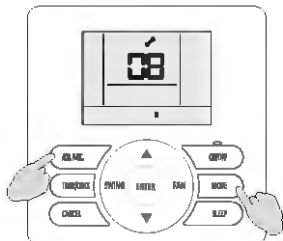

fig.4

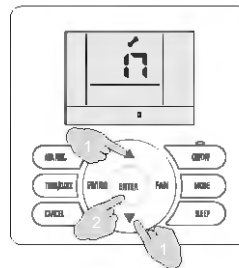









fig.5

2. Press  or , and the parameter code increases or decreases by 1 accordingly. When 17 displays, press ENTER button to rewrite EE parameter of the indoor unit, at the same time, the symbol  lights and EE parameter code 00 blinks.(See fig.5)
3. Press  or , and the EE parameter code increases or decreases by 1 accordingly and the corresponding value of EE displays in the Timer display area. When the EE code needs to be rewritten displays, press ENTER button to come to EE rewriting mode, at the same time the symbol  lights, EE parameter code lights and the value of EE blinks. For the EE parameter code, see Table 2.
4. When the value of EE blinks, press  or  to adjust it until the value needed displays, at this time, press ENTER button to save it. For example, the diagram above shows that when the parameter code is 1 (Self-recovery of power break), the function of self-recovery of power break can be realized.
5. Press ON/OFF button to quit to # 17, press ON/OFF button again to exit from the parameter rewriting state.

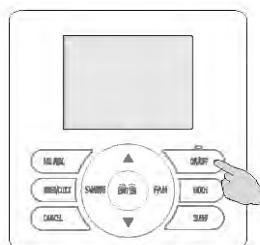

fig.5

2. Wired Controller(YXE-C02U1(E))

Table 2

Parameter Code	Parameter Description	Parameter Value&Representation		NOTE
		Data Type	Representation (Function Code)	
1	Self recovery of power break	Integer	0: Cancel self recovery of power break function; 1: Self recovery of power break; others: invalid.	
2	Temperature type	Integer	0: Centigrade temperature; 1: Fahrenheit temperature; others: invalid.	
3	Temperature display type	Integer	0: Default display set temperature; 1: Default display room temperature; others: invalid.	
4	Ratio of ambient temperature sensed by indoor temperature sensor(cooling mode)	Integer	0~10valid, more than 10default is 10 0:0%; 1:10%;...; 10:100%	0:entirely use temperature sensed by wired remote controller; 10:entirely use temperature sensed by indoor unit
5	Filter clean indication	Integer	0: Default display set temperature 1: Default display room temperature others: invalid	
6	Filter clean time set	Integer	0~32, more than 32 default is 32*1000h	
7	Installation height compensation	Integer	0~10m, more than 10m default is 10. =0,1,2: no fan speed compensation =3: increase fan speed =4~10: increase more fan speed	
8	Cooling temperature compensation(indoor unit temperature sensor)	Integer	0: 0°C;1:-0.5°C;2:-1°C;3:-1.5°C;4:-2°C; 5:-2.5°C;6:-3.0°C;7:-3.5°C;8:-4°C;9:-4.5°C; 10:-5°C (the wired controller displays integer with symbol)	
9	Heating temperature compensation(indoor unit temperature sensor)	Integer	0: 0°C;1:-0.5°C;2:-1°C;3:-1.5°C;4:-2°C; 5:-2.5°C;6:-3.0°C;7:-3.5°C;8:-4°C;9:-4.5°C; 10:-5°C (the wired controller displays integer with symbol)	
10	Static pressure set	Integer	1~250, function code=static pressure more than the limit static pressure default the limit static pressure, default is 0 (default static pressure, related to models)	Duct type(DC motor)
12	Ratio of temperature sensed by indoor temperature sensor(heating mode)	Integer	0~10valid, more than 10 default is 10 0:0%; 1:10%;...; 10:100%	0:entirely use temperature sensed by wired remote controller; 10:entirely use temperature sensed by indoor unit
13	Temperature adjustment-cooling	Character	-10~10°C (single character with symbol)	Temperature displayed on wired controller
14	Temperature adjustment-heating	Character	-10~10°C (single character with symbol)	Temperature displayed on wired controller
25	Access control, fire protection, ON/OFF function set	Integer	=0, access control, fire protection functions are all invalid; =1, access control function is valid; =2, fire protection function is valid; =3, access control, fire protection are all valid; =4, ON/OFF function are all valid.	

2. Wired Controller(YXE-C02U1(E))

Self-setting Parameters

The internal parameters of the wired controller can be set with the actual usage conditions. The catalogue of custom-setting parameters is shown as follows:

Custom-setting Parameter Code	Implication of Code Display	Description	Remarks
01	Version No.		
03	boot	Restore factory default	
04	Integrated control Baud rate setting	0-9600bps;1-19200bps; 2-38400bps;3-76800bps	
05	Is remote control/button operation setting permitted or not	0-Remote control/button permitted; 1-Reserved; 2-Button prohibited; 3-Remote control/button prohibited; see the table3 on the right for more content	
06	Temperature display setting	0-Display the set temperature; 1-Display the indoor room temperature	The factory setting defaults to 0
07	Temperature measurement unit display setting	0-Display in Celsius; 1-Display in Fahrenheit degree	
08	Cooling-only setting	0-Heat pump type air conditioner; 1-Cooling-only air conditioner	
09	Address revision setting	0-Address revision prohibited; 1-Address revision permitted	
10	Temperature limits revision setting	0-Prohibited; 1-Permitted	
11	Room temperature revision setting	0-Prohibited; 1-Permitted	

Table 3

NO	Description
0	Remote control/button permitted
1	Remote control prohibited
2	Button prohibited
3	Remote control/button prohibited
5	Turning ON/OFF by remote control prohibited
13	Turning on by remote control & MODE setting prohibited
17	Temperature setting by remote control prohibited
21	Temperature setting by remote control prohibited & ON/OFF setting prohibited
25	Temperature setting by remote control prohibited & MODE setting prohibited
29	Temperature setting by remote control prohibited & MODE setting & ON/OFF setting prohibited
33	Fan speed setting prohibited
37	Fan speed & ON/OFF setting prohibited
41	Fan speed & MODE setting prohibited
45	Fan speed & MODE & ON/OFF setting prohibited
49	Fan speed & temperature setting prohibited
53	Fan speed & temperature & ON/OFF setting prohibited
57	Fan speed & temperature & MODE setting prohibited
61	Fan speed & temperature & MODE & ON/OFF setting prohibited
65	Swing setting prohibited
69	Swing & ON/OFF setting prohibited
73	Swing & MODE setting prohibited
77	Swing & MODE & ON/OFF setting prohibited
81	Swing & temperature setting prohibited
85	Swing & temperature & ON/OFF setting prohibited
89	Swing & temperature & MODE setting prohibited
93	Swing & temperature & MODE & ON/OFF setting prohibited
97	Fan speed & swing setting prohibited
101	Fan speed & swing & ON/OFF setting prohibited
105	Fan speed & swing & MODE setting prohibited
109	Fan speed & swing & ON/OFF & MODE setting prohibited
113	Fan speed & swing & temperature setting prohibited
117	Fan speed & swing & temperature & ON/OFF setting prohibited
121	Fan speed & swing & temperature & MODE setting prohibited
125	Fan speed & swing & temperature & ON/OFF & MODE setting prohibited

The Method of Setting the Custom Parameters

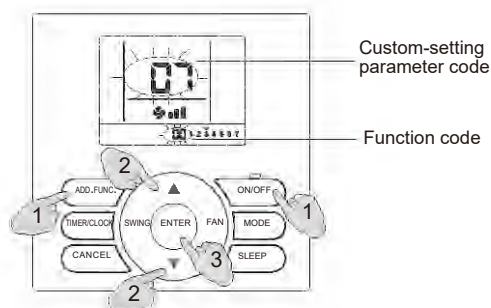

1. Press and hold "ADD. FUNC" and "ON/OFF" buttons at the same time for 3s, to access the custom-setting mode, and the custom-setting parameter code will flicker on the screen.
2. Press the "▲" button (plus) or "▼" button (minus) to select the custom-setting parameter code that is required to be set, and press the "ENTER" button, with the function code displayed in flickering.
3. Press the "▲" (plus) button or "▼" (minus) button to select the function code, and press the "ENTER" button to confirm the setting.

How to exit:

Press "Cancel" button to exit when any custom-setting code is displayed.

2. Wired Controller(YXE-C02U1(E))

Parameter Setting

The wired controller room temperature display, limit set temperature, maximum quantity of central control and address can be revised if needed. Before setting, please check if these parameters are enabled to be revised, for details, see **Custom parameters**.

1. Room Temperature Correction

Setting of room temperature correction is for particular cases (e.g. installation location near the marble wall): the wired controller is set to display the room temperature, but the room temperature detected is different from the actual room temperature, so setting correction is necessary.

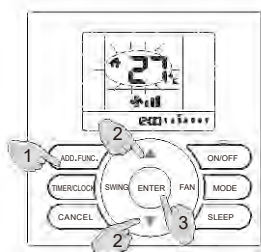

Room Temperature Correction

Setting method:

- Under the OFF conditions, press “▲” or “▼” button to display the icon.
- Hold down the “ADD.FUNC.” for 3s, the buzzer will beep for four times to alert that it goes into the room temperature modification state. The room temperature value and icon start flickering at the same time.
- Press “▲” (plus) button or “▼” (minus) button to select the room temperature value within an offset of $\pm 10^{\circ}\text{F}/^{\circ}\text{C}$ of the current temperature, press the “ENTER” button to confirm the setting, save the setting and exit.

How to cancel:

In room temperature correction mode, press “CANCEL” button to cancel correction and exit.
Press any other button (except MODE button) to exit room temperature correction directly.

2. Temperature Limit Setting

Default temperature range is $(61-86)^{\circ}\text{F}[(16-30)^{\circ}\text{C}]$. You can change the range when needed. For example, in cooling mode, temperature adjustment range could be changed to $(73-86)^{\circ}\text{F}[(23-30)^{\circ}\text{C}]$; in heating mode, it could be changed to $(61-73)^{\circ}\text{F}[(16-23)^{\circ}\text{C}]$. The temperature limit is only effective for the cooling and heating modes.

Setting method:

- Under OFF conditions, Press down the “▲” (plus button) or “▼” (minus button) to adjust the wired controller to display .
- Hold down the “ADD. FUNC.” button for 3s, and the buzzer will beep for four times to alert that it goes into the setting temperature limit state. The wired remote controller’s limit temperature value and icon will flicker.
- Press the “▲” button (plus) or “▼” button (minus) to adjust the temperature limit value within the range of $(61\sim 86)^{\circ}\text{F}[(16\sim 30)^{\circ}\text{C}]$, and if you press the “MODE” button, it will change in the following sequence:



Press “ENTER” button to save the change and exit. After setting, the limit temperature icon and numerical value icons stop flickering.

How to cancel:

Under the state of temperature limit setting, press the “CANCEL” button to cancel setting and exit. Press any other button (except the MODE button) to exit from the temperature limit setting directly.

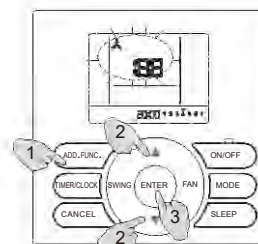

Setting of maximum quantity under integrated control

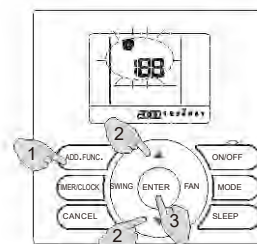

Address setting

3. Setting of Maximum Quantity of Central Control

It is used to set the maximum quantity under central control.

- Under OFF conditions and if there is no RTC setting, you can press the “▲” (plus button) or “▼” (minus button) to adjust till the wired remote controller displays the integrated control icon .
- Hold down the “ADD.FUNC.” button for 3s, the buzzer will beep to alert that it enters the modification setting state, and the LCD will show the central control icon and central control quantity is flickering.
- Press the “▲” button (plus) and “▼” button (minus) to adjust, the central control quantity setting range is 1-128, and after pressing the “ENTER” button to confirm the setting, the icon and central control quantity icon will stop flickering, indicating that the setting is completed.

How to cancel:

Press “CANCEL” button in address setting mode to cancel correction and exit.
Press any other key to exit address setting directly.

2. Wired Controller(YXE-C02U1(E))

4. Address Setting

It is used to set the address of wired remote controller if there is central control.

Setting method:

1. Under OFF conditions and if there is no RTC setting, you can press the “▲” button (plus) or “▼” button (minus) to adjust till the wired remote controller displays @ .
2. Hold down the “ADD. FUNC.” button for 3s, the buzzer will beep to alert that it goes into the address setting state.
The LCD will show the address setting icon @ and address icon ■ is flickering.
Press the “▲” button (plus) and “▼” button (minus) to adjust the address, the address setting range is 1-128, and you can not adjust in excess of the maximum controlled quantity for central control setting.
3. Press the “ENTER” button to confirm the setting, and then the address icon and address numerical value icon will stop flickering, indicating that the setting is completed.

5. DIP setting

Please set the DIP switch code based on the practical situations, which will work if it is dialed before power on.



NOTE: The symbol “■” represents the position where the DIP locates.

Dial Code	Dial Content	Setting Method
SW16-1	Fuse short-circuit setting	After the fuse on electric control board blows, you can dial the dial code to ON to restore the integrated control communication.
SW16-2	Terminal resistance setting	In order to guarantee the communication speed, it must be set as ON if being at the both ends of integrated control system.

2. Wired Controller ŽYXE-E01U(E)/YXE-E02U(E)ž

2.4 YXE-E01U(E)/YXE-E02U(E)

2.4.1 Function Introduction

Part Names

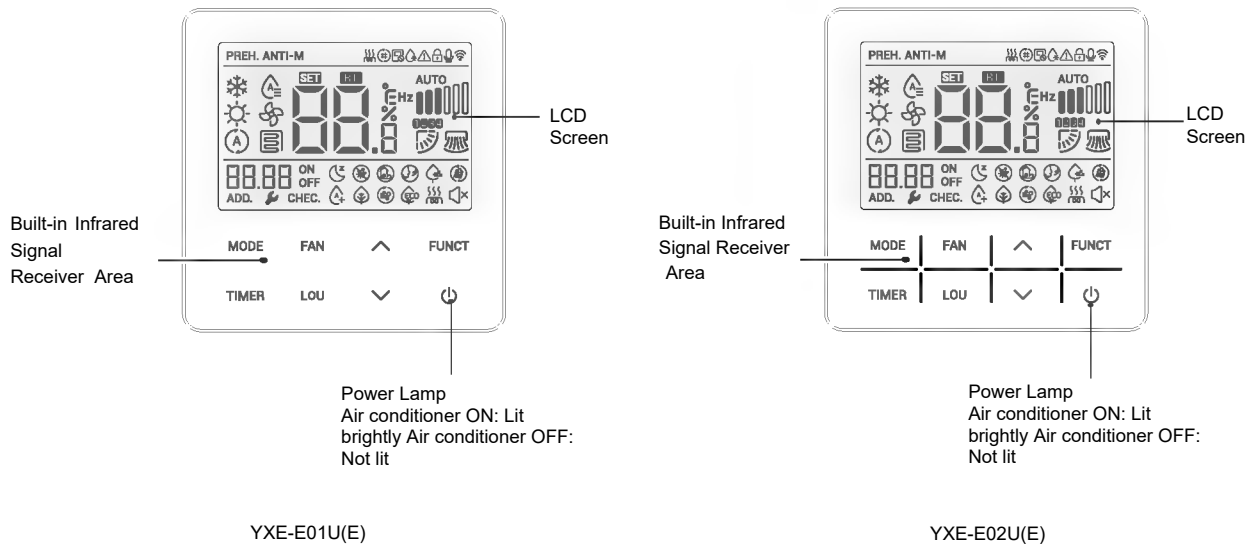

Button Introduction

Button	Instruction	Function
	ON/OFF Button	Press this button to turn on/off the appliance. Press it for more than 3s to reset the Filter clean function.
MODE	Mode Button	Press this button to set mode.
FAN	Speed Button	Press this button to set fan speed. Press it for more than 3s to on/cancel buzzer.
LOU	Swing Button	Press this button to set swing.
	Up Button	Press this button to increase the temp.
	Down Button	Press this button to decrease the temp.
TIMER	Timer Button	Press this button to set timer mode. Press it for more than 3s to cancel timer.
FUNCT	Function Button	Press this button to set special functions (health, self-cleaning, super cooling/heating, energy saving, Mute, sleep).

2. Wired Controller ZYXE-E01U(E)/YXE-E02U(E)

LCD Screen

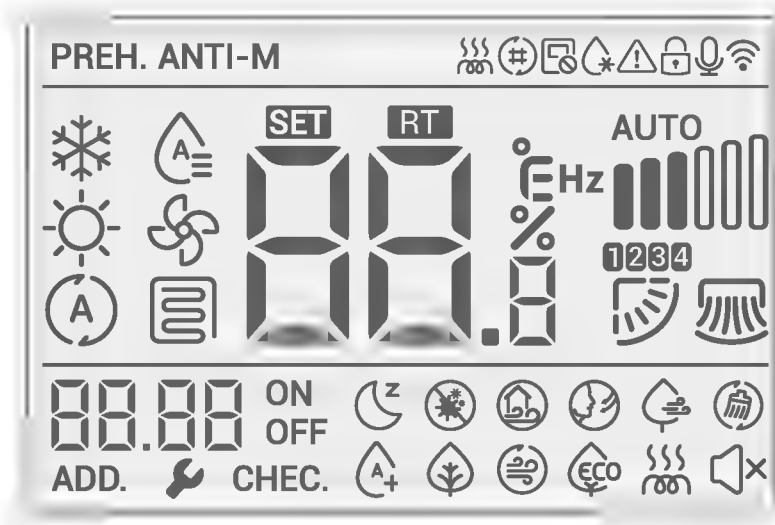

	Electric heater		Filter		Centralized control prohibition sign		Defrost
	Alarm		Button lock		Indoor unit voice sign		Wi-Fi
	Cooling mode		Dry mode		Fan-only mode		Heating mode
	AUTO		Floor heater		Auto fan speed		Ultralow fan speed
	Low fan speed		Medium fan speed		High fan speed		Ultrahigh fan speed
	Group select		Up/Down airflow swing		Left/Right airflow swing		Set temperature
	Check Indicator		Room temperature		Address Setting		Error Indicator
	Temperature		Celsius Temperature		Fahrenheit Temperature		Frequency
	Relative Moisture		Clock		Timer ON		Timer OFF

Special functions:

	Sleep indicator		Sterilization		Fresh air		The wind avoids people
	Natural air		Self-clean		Humidification		Health
	Super cooling/heating		Energy-saving		Electric heater		Mute

NOTE:

- (1) For purpose of explanation, all parts of the display are shown. During actual operation, only the relevant items will be displayed.
- (2) Heating is not available for single cooling only models.
- (3) Air direction, Filter Clean, Hot Water, Floor Heat, Filter Clean, Ventilation, Electric Heating etc. are only available for specific models, details please refer to operation manual.
- (4) ERROR and Maintenance, Address Setting, Fahrenheit Temperature must be configured by installer or authorized person.

2. Wired Controller(YXE-E01U(E)/YXE-E02U(E))

Simple Operation

This wire controller should be used with the air conditioner. it can be used for cooling, heating, dry and fan etc. For other functions and settings, please refer to the specific operation in this manual.

1. Turning ON/OFF

Press the “” button, the appliance will be started or stopped.

2. Mode setting

Press " **MODE** " button to select operation mode.

Each time " **MODE** " button is pressed, the operation mode will change in the following sequence:



NOTE:

AUTO mode is invalid for models without AUTO mode when setting. HEATING mode is invalid for cooling only types or heating-forbidden air conditioners.

3. Temperature setting

Press the " ^ " or " v " button to enter the temperature setting state.

Each time " ^ " or " v " button is pressed, temperature setting increases/decreases by 0.5°F/0.5°C.

Temperature setting range	
COOLING, HEATING, DRY	16°C~ 30°C (61°F~86°F)
FAN ONLY	Unavailable for setting

NOTE:

- (1) Heating mode is invalid for cooling-only air conditioners.
- (2) The default setting range depends on the indoor unit, some models are 18~32°C, and some models are 20~28°C.
- (3) Setting range can be changed by professional staff, and for detailed operations, please contact the installation service/ after-sales service center.
- (4) When the set temperature reaches the upper or lower limits setting temperature will not increase or decrease.

4. Fan speed setting

Press the “ **FAN** ” button to adjust the fan speed. The fan speed will change in the following sequence:



NOTE:

- (1) AUTO fan speed is invalid for “FAN” mode.
- (2) AUTO fan speed is the default setting under Dry mode, and it can't be adjusted.

2. Wired Controller(YXE-E01U(E)/YXE-E02U(E))

5. Airflow swing setting

Under the ON conditions or under the OFF conditions when TIMER ON function is enabled, press the "LOU" button to adjust the airflow direction.

The airflow direction setting will change in the following sequence by default:

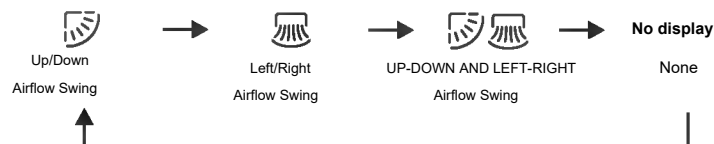

NOTE:

This function is only applicable to the air conditioning units with the swing function.

6. Individual airflow swing setting

For a unit with multiple air outlets, each air outlet swing position could be set separately. Up to four air outlets could be set.



How to activate:

- (1) Press the "LOU" button and then press the "∧" or "∨" button to select serial number of the air outlet, or select all the four air outlets 1234 together.
- (2) Press the "LOU" button 2 times and then press the "∧" or "∨" button to select the upper and lower swing position between Auto and other 6 positions.
- (3) Press the "LOU" button 3 times and then press the "∧" or "∨" button to select the left and right swing position between Auto and other 6 positions.
- (4) Press the "LOU" button to set swing positions of next group of air outlets.

How to cancel:

No operation Within 5s to exit settings.

Function Setting

Super mode

The maximum cooling/heating capacity can be activated at the super mode.

How to activate:

1. Press the "FUNCT" button under ON state;
2. Press the "∧" / "∨" to select the "⊕" icon, which will flicker then;
3. Press the "FUNCT" button again to confirm the sett the high power mode, then the unit will run at high speed "||||".

How to cancel:

Repeat the operations mentioned above to select the "⊕" icon, which will disappear then.

Switch the "ON/OFF", "Mode", "Sleep", "Mute" and "Energy Saving" mode to exit directly. No operation within 5s to exit settings.

NOTE:

If you operate the Super mode under COOLING and DRY modes, the unit will automatically go into forced cooling mode with lowest set temperature, or go into forced heating mode with highest set temperature under the heating mode.

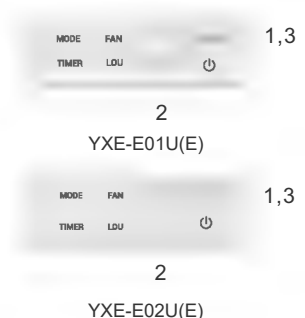

2. Wired Controller(YXE-E01U(E)/YXE-E02U(E))

Mute mode

The Mute mode reduces the noise by changing the fan speed of indoor unit so as to keep quiet during operation at night.

How to activate:

1. Press the "FUNCT" button under cooling/ heating/ fan state;
2. Press the "∧" / "∨" button to select "🔊" icon, which will flicker then;
3. Press the "FUNCT" button again to confirm the settings. And the air speed will be "1" (i.e. the air speed for mute operation) under mute mode.

How to cancel:

Repeat the operations mentioned above to select the "🔊" icon, which will disappear then. Switch the "ON/OFF", "Mode", "Sleep", "Super cooling/heating" and "Energy-Saving" mode to exit directly.

No operation Within 5s to exit settings.

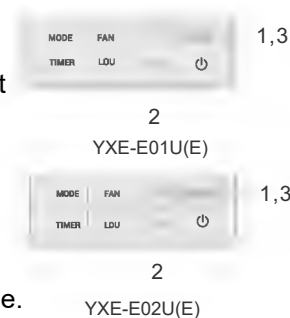

Sleep mode

With the sleep function, the air conditioner will run in the mode of comfortable sleep to improve comfort.

How to activate:

1. Press the "FUNCT" button under cooling/heating/drying state;
2. Press the "∧" / "∨" button to select "🌙" icon, which will flicker then;
3. Press the "FUNCT" button again to confirm the settings to enter into sleep mode.

How to cancel:

Repeat the operations mentioned above to select the "🌙" icon, which will disappear then. Switch the "ON/OFF", "Mode", "Fan speed", "Super cooling/heating", "Mute" and "Energy Saving" mode to exit directly.

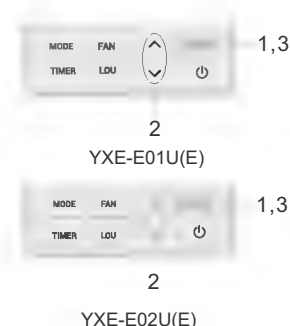

Button lock

After the wired controller setting is completed, lock buttons to avoid wrong operation by children and others. All operations are disabled after button lock function has been set.

How to activate:

Press and hold "∧" and "∨" button for 3s to activate button lock function, and icon 🔒 will be displayed on the LCD.

How to cancel:

Press and hold "∧" and "∨" button for 3s again to unlock, and icon 🔒 will disappear from the LCD.

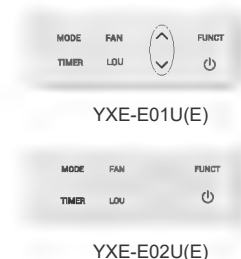

Filter cleaning resetting

(available for models equipped with filter clean prompt function; only professional staff should operate this function.)

When 🧼 is displayed on LCD, indicates that the filter needs to be cleaned. Please contact professional staff to perform cleaning.

After cleaning, press and hold "🔊" button for 3s to reset warning prompt.

NOTE:

- (1) FILTER CLEAN screen prompt is only available for some models. For details, please refer to indoor unit manuals.
- (2) Be sure to stop the operation and turn off the power supply before performing any cleaning.

Buzzer indicator select

Default buzzer is valid during operation. If you need mute operation, press the "FAN" button for 3s to enter the mute mode. If you need it returns to normal operation, repeat the steps above.

Back light setting

By default, the back light is on and the indicator lights during operation. If you want to cancel it, do not operate any button within 10s after the back light turns on. Then, the back light will turn off, If you want to re-activate it, just repeat as mentioned above.

2. Wired Controller(YXE-E01U(E)/YXE-E02U(E))

Wi-Fi setting

Press and hold the " LOU " and " FUNCT " buttons for 3s to enter the Wi-Fi setting state. After setting successfully, the Wi-Fi indicator "  " will be displayed. If the Wi-Fi indicator is not displayed, it means that the network setting is failed and needs to be reset.

Single TIMER ON

<ck`tc`UWj`jH.

1. During OFF condition, press " TIMER " button until icon "ON" and clock setting are flickering.
2. Press " ^ " / " v " button to adjust the time, the timing time flickers and the icon " ON " appears. Each time " ^ " / " v " button is pressed, timer setting increases/ decrease by 0.5h. It can be set from 0h to 24h, and timer setting resolution is 0.5h.
3. Press the " TIMER " button again to confirm and exit.
After the settings are completed, the timing icon " ON " will appear and the timer countdown will be displayed as per the minimum unit(0.5h).

How to cancel:

Press and hold the button " TIMER " for 3s to exit.

NOTE:

- (1) The fan speed/ LOU/ mode/ temperature still can be adjusted as required after settings are completed.
- (2) If any change to time is necessary after the settings are completed, the procedures are the same as those of setting.
- (3) The timing setting is unavailable in case of a failure.
- (4) If timing operation of the indoor unit has been performed by another remote control, when the wired controller is operated, the timing time can only be displayed and cannot be changed.

Single TIMER OFF

You can set TIMER OFF with the same method when the appliance is ON.

Health mode

How to activate

1. Press the " FUNCT " button under ON state;
2. Press the " ^ " / " v " button to select "  " icon, which will flicker then;
3. Press the " FUNCT " button again to confirm the setting to enter health mode.

<ck`tc`WbW.

Repeat the operations mentioned above to select the "  " icon, which will disappear then. Switch the "ON/OFF", "Mode" to exit directly.

Energy-saving mode

Under the energy-saving mode, the air conditioner will run more energy-saving.

How to activate:

1. Press the " FUNCT " button under cooling/ heating/ drying state;
2. Press the " ^ " / " v " button to select "  " icon, which will flicker then;
3. Press the " FUNCT " button again to confirm the settings to enter into Energy saving mode.

How to cancel:

Repeat the operations mentioned above to select the "  " icon, which will disappear then. Switch the "ON/OFF", "Mode", "Fan speed", "Sleep", "Mute" and "Temperature setting" mode to exit directly.

NOTE:

Energy-saving function is invalid in dehumidification/ super cooling/ heating mode.

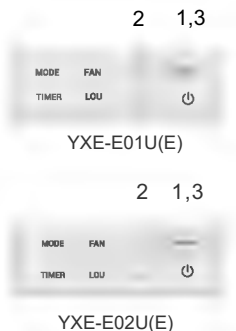
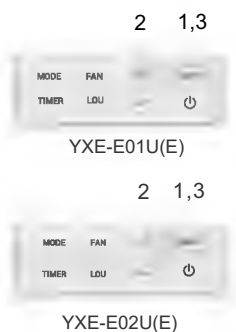
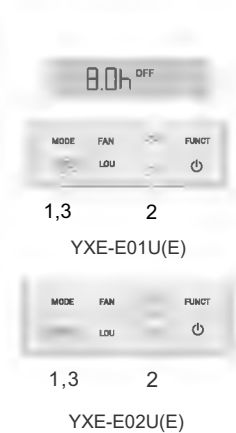

2. Wired Controller(YXE-E01U(E)/YXE-E02U(E))

Self-cleaning mode

Under the self-cleaning mode, the indoor unit/ outdoor unit will activate the self-cleaning operation.

How to activate:

1. Press the " FUNCT " button under ON state;
2. Press the " ^ " / " v " button to select the " 🌀 " icon, which will flicker then;
3. Press the " FUNCT " button again to confirm the settings and enter the self-cleaning mode and the temperature will be displayed in a dynamic manner.

How to cancel:

Repeat the operations mentioned above to select the " 🌀 " icon, which will disappear then. Switch the "ON/OFF", "Mode" mode to exit directly.

NOTE:

- (1) This function is only applicable to the air conditioning units with the self-cleaning function.
- (2) The selection of self-cleaning mode is unavailable under the timing/sleep mode.

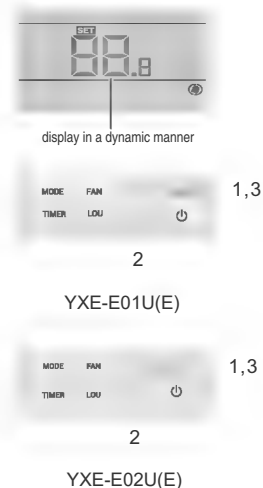

Maintenance

1. Wipe the LCD or the body of the wired controller with a dry cloth.
2. If the dirt on the surface cannot be removed, soak the cloth in neutral detergent diluted with water, squeeze the cloth tightly and clean the surface. Wipe the surface with a dry cloth.
3. Do not use any thinner, organic solvents, or strong acid.

Troubleshooting and After-sales Service

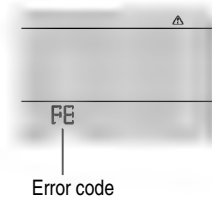

When the air conditioner malfunctions, ⚠ will be displayed on the LCD, indicating that error is occurring, please consult your local dealer or after-sales service.

2. Wired Controller(YXE-E01U(E)/YXE-E02U(E))

2.4.2 Installation Manual

Install it by professionals and confirm that the power supply has been turned off before installation. This product shall be installed in a well-ventilated environment and kept far away from heat source. During installation, always confirm that the wired controller and indoor unit of the air conditioner controlled by it are in the same room.

Please install it as per the following procedures:

1. Selecting the Installation Location.

Please select the installation location according to **safety precautions**.

2. Removing the upper cover of the wired controller.

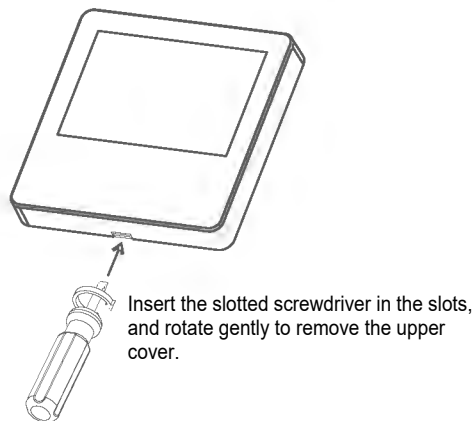

Note:

Control board of the wired controller is placed on upper cover. Please protect it from being scratched during removal and installation!

3. Pull the connection cord of the wired controller out of the embedded terminal box and pass the wire out of the back out hole.

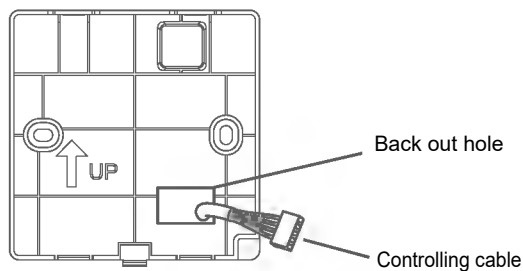

4. Securing the lower cover.

Please secure the lower cover with the attached screws (2 pcs) on the wall or embedded box.



2. Wired Controller(YXE-E01U(E)/YXE-E02U(E))

5. Wiring

Connect the controlling cable with upper cover terminal as the figure below.

Connect the attached controlling cable with indoor unit control board.

For details of the specific wiring terminals, please refer to wiring diagram of the indoor unit.

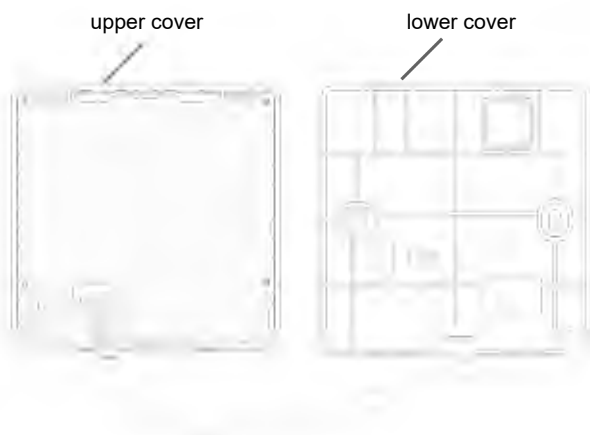

Note:

The connecting wires shall be secured firmly after connection. In order to prevent any water and insects from entering into the opening where the wire is led into, the opening shall be practically sealed with putty(to be provided on the site).

6. Upper cover assembly

Align the upper cover with the hasp of lower cover of the wired controller, and then press the upper cover onto the lower cover. After installation, tear off protective sticker attached on the display of wired controller.

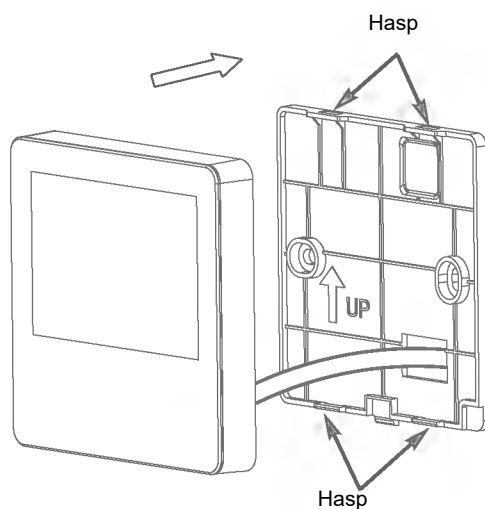

2. Wired Controller(YXE-E01U(E)/YXE-E02U(E))

2.4.3 Checking and Setting

Custom parameters

The internal parameters of the wired controller can be set with the actual usage conditions.

The method of setting the custom parameters:

1. Press and hold the “ FUNCT ” and “ MODE ” button for 3s at the same time to enter the parameter self-setting state, Then the “ CHEC.” and “ ADD.” icon will be always on.
2. Press the “ MODE ” / “ TIMER ” button to increase or decrease the root address as 1.
3. Press the “ FAN ” / “ LOU ” button to increase or decrease the sub-address, and select the desired sub-address value.
4. Press the “ ^ ” / “ v ” button to set parameters, and press “ FUNCT ” button to confirm.
5. Press the “ ⏻ ” button to exit without settings.

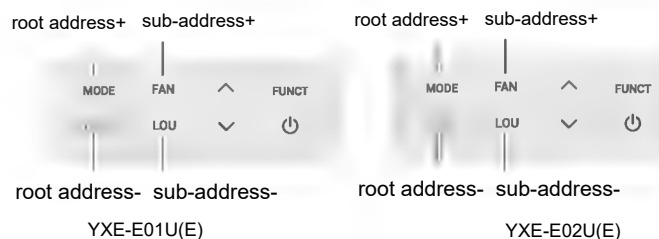
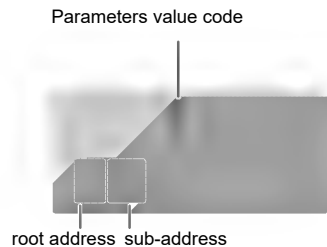

The catalogue of custom-setting parameters is shown as follows:

Self-setting parameter code	Implication of code display	Description	Remarks
03	boot	When “ boot ” flicker, press “ FUNCT ” to restore to factory state and exit.	
06	Temperature display setting	0-Display the set temperature; 1-Display the indoor temperature	The factory setting defaults to 0
07	Fahrenheit degree display setting	0-Display in degree centigrade; 1-Display in Fahrenheit degree	
08	Cooling-only setting	0-Heat pump type air conditioner; 1-Cooling-only air conditioner	
10	Temperature limits revision setting	0-Not permitted; 1-Permitted	
11	Environment temperature revision setting	0-Not permitted; 1-Permitted	

2. Wired Controller(YXE-E01U(E)/YXE-E02U(E))

Parameter setting

The wired controller room temperature display, limit set temperature, maximum quantity of central control and address can be revised if needed. Before setting, please check if these parameters are enabled to be revised, for details, see **Custom parameters**.

Temperature limit setting

Default temperature range is (16-30)°C. You can change the range when needed. For example, in cooling mode, temperature adjustment range could be changed to (23-30)°C, in heating mode, it could be changed to (16-23)°C.

Setting method:

1. During OFF conditions, press and hold the "FUNCT" and "∨" buttons at the same time for 3s to enter parameter setting mode, and the icon **SET** will be displayed on the LCD.
2. Press the "∧" / "∨" button to adjust the temperature limit value within the range of (16-30)°C.
3. Press the "FUNCT" button to confirm the setting, or wait for 5s, save the setting and exit.

How to cancel:

Press the "⏻" button to exit without settings.

NOTE:

Temperature limit setting function is valid for cooling and heating modes.

Room temperature correction

Setting of room temperature correction is for particular cases (e.g. installation location near the marble wall): wired controller is set to display room temperature, but the room temperature detected will be different from the actual room temperature, so setting correction is necessary.

Setting method:

1. During OFF conditions, press and hold the "FUNCT" and "∧" buttons at the same time for 3s to enter parameter setting mode, and the icon **RT** will be displayed on the LCD.
2. Press the "∧" / "∨" button to adjust the room temperature value within an offset of -20~20°C of the current temperature.
3. Press the "FUNCT" button to confirm the setting, or wait for 5s, save the setting and exit.

How to cancel:

Press the "⏻" button to exit without settings.

NOTE:

Room temperature correction function is valid for cooling and heating mode.

Temperature limit value



YXE-E01U(E)



YXE-E02U(E)

Room Temperature correction value



Offset value

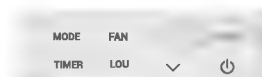

YXE-E01U(E)

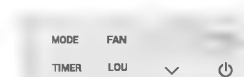

YXE-E02U(E)

2. Wired Controller(YXE-E01U(E)/YXE-E02U(E))

Read the operating parameters of indoor unit

The internal parameters of the air conditioner can be set with the following method.

Instruction

1. Press and hold the “FUNCT” and “MODE” button for 3s at the same time to enter the parameter self-setting state, Then the “CHEC.” and “ADD.” icon will be always on.
2. Press the “MODE” / “TIMER” button to increase or decrease the root address as 2.
3. Press the “FAN” / “LOU” button to increase or decrease the sub-address, and select the desired sub-address value.
4. Press the “” button to exit without settings.

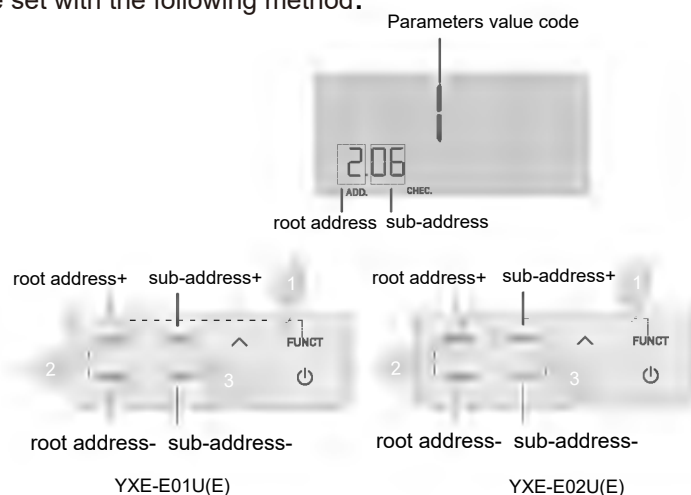

The catalogue of custom-setting parameters is shown as follows:

Sub-address parameter code	Parameter description	Parameter code	Parameter description
00	Slave unit model	34	Indoor unit address
01	Indoor unit model	35	System address
02	Outdoor unit model	36	Local indoor unit address
03	Program version number of indoor unit	37	Outdoor unit operation mode
04	Indoor unit capacity code	38	Number of outdoor units started
05	Program version number of outdoor unit	39	Number of indoor units started
06	Return air temperature of indoor unit	40	Number of indoor units allocated during automatic allocation
07	Indoor unit coil temperature	41	Target frequency
08	Outdoor ambient temperature	42	Driving frequency
09	Compressor exhaust temperature	43	Outdoor unit defrosting temperature
10	Compressor return air temperature	44	Target defrosting temperature
11	Outdoor condenser temperature	45	Water inlet temperature of water module
12	Compressor discharge pressure	46	Water outlet temperature of water module
13	Compressor suction pressure	47	Temperature after indoor electric heating
14	Outdoor unit electronic expansion valve opening	48	Inlet temperature of gas replenishment and enthalpy increase
15	AC input current	49	Outlet temperature of gas replenishment and enthalpy increase
16	Effective value of AC voltage	50	Inlet temperature of water heater
17	Indoor unit built-in EE	51	Outlet temperature of water heater
18	Indoor unit external EE	52	Water heater temperature1
19	Outdoor unit built-in EE	53	Water heater temperature2
20	Outdoor unit external EE	54	Computing power requirements
21	Clock	55	Target speed of fan1
22	Time-lapse function status	56	Target speed of fan2
23	Wire controller sampling indoor ambient temperature	57	Actual speed of fan1
24	Fault code	58	Actual speed of fan2
25	Drive board fault code	59	Indoor target speed
26	Air outlet temperature of indoor unit	60	Indoor actual speed
27	Indoor unit electronic expansion valve opening	61	Opening of air replenishment enthalpy increasing valve
28	Compressor current	63	Indoor unit characteristic code
29	Indoor unit body temperature	64	Registration code
30	Inlet temperature of indoor unit coil	65	Registration information
31	Outlet temperature of indoor unit coil	66	Network D information
32	Inlet temperature of outdoor condenser		
33	Outlet temperature of outdoor condenser		

2. Wired Controller(YXE-E01U(E)/YXE-E02U(E))

Read and write EEPROM parameters of indoor unit

The internal parameters of the air conditioner can be set with the following method.

Instruction

1. Press and hold the “ FUNCT ” and “ MODE ” button for 3s at the same time to enter the parameter self-setting state, Then the “ CHEC. ” and “ ADD. ” icon will be always on.
2. Press the “ MODE ” / “ TIMER ” button to increase or decrease the root address as 3.
3. Press the “ FAN ” / “ LOU ” button to increase or decrease the sub-address, and select the desired sub-address value.
4. Press the “ ^ ” / “ v ” button to set parameters, and press “ FUNCT ” button to confirm.
5. Press the “ ⏻ ” button to exit without settings.

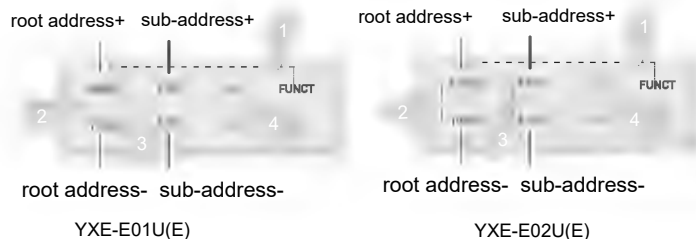
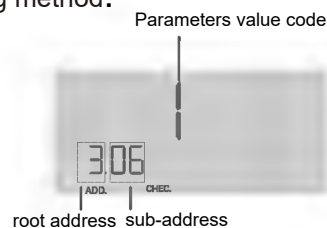

The catalogue of Read and write EEPROM parameters is shown as follows:

Sub-address parameter code	Parameter description	Parameter Representation (Function Code)	NOTE
01	Self-recovery of power break	0: Cancel self-recovery of power break function; 1: Self recovery of power break; others: invalid.	
02	Temperature type	0: Centigrade temperature; 1: Fahrenheit temperature; others: invalid.	
03	Temperature display type	0: Default display set temperature; 1: Default display room temperature; others: invalid.	
04	Ratio of indoor unit body temperature (cooling mode)	0~10valid, more than 10default is 10 0:0%; 1:10%;...;10:100%	0: entirely use temperature sensed by wired remote controller; 10:entirely use temperature sensed by indoor unit
05	Filter clean indication	0: Default display set temperature 1: Default display room temperature others: invalid	
06	Filter clean time set	0~32, more than 32 default is 32*1000h	
07	Installation height compensation	0~10m, more than 10m default is 10. =0,1,2: no fan speed compensation =3: increase fan speed =4~10: increase more fan speed	
08	Cooling temperature compensation(indoor unit temperature sensor)	0: 0°C;1:-0.5°C;2:-1°C;3:-1.5°C;4:-2°C; 5:-2.5°C;6:-3.0°C;7:-3.5°C;8:-4°C;9:-4.5°C; 10:-5°C (the wired controller displays integer with symbol)	
09	Heating temperature compensation(indoor unit temperature sensor)	0: 0°C;1:-0.5°C;2:-1°C;3:-1.5°C;4:-2°C; 5:-2.5°C;6:-3.0°C;7:-3.5°C;8:-4°C;9:-4.5°C; 10:-5°C (the wired controller displays integer with symbol)	
10	Static pressure set	0~240, function code=static pressure more than the limit static pressure default the limit static pressure.	

2. Wired Controller(YXE-E01U(E)/YXE-E02U(E))

11	Indoor unit capacity setting	1. Setting mode of unit/ frematch:0-255, actual value= indicated value * 100(W). 2. VRF setting mode: 0 = 3500W; 1 = 2200 W; 2 = 2500 W; 3 = 2800 W 4 = 3200 W; 5 = 3600 W; 6 = 4000 W; 7 = 4600 W 8 = 5000 W; 9 = 5600 W; 10 = 6300 W; 11 = 7100 W 12 = 8000 W; 13 = 11200 W; 14 = 14000 W; 15 = 24000 W	
12	Ratio of indoor unit body temperature (heating mode)	0~10valid, more than 10 default is 10 0:0%; 1:10%;...;10:100%	0:entirely use temperature sensed by wired remote controller; 10:entirely use temperature sensed by indoor unit
13	Temperature adjustment-cooling	-10~10°C (single character with symbol)	Temperature displayed on wired controller
14	Temperature adjustment-heating	-10~10°C (single character with symbol)	Temperature displayed on wired controller
15	Indoor unit address	Address= set value	
16	System address	Address= set value	
17	Group address	Address= set value	
18	Self-recovery of cooling/heating temperature limit	=0, cooling/ heating temperature limit is invalid; =1, cooling temperature limit is valid, heating temperature limit is invalid. =2, heating temperature limit is valid, cooling temperature limit is invalid. =3, cooling/ heating temperature limit is valid.	
19	Minimum cooling temperature setting	Set value= actual temperature(16°C-30°C)	
20	Maximum heating temperature setting	Set value= actual temperature(16°C-30°C)	
21	VIP setting	=0, no VIP; =1, set to VIP	
22	Group control temperature effective setting	=0, group control temperature effective is invalid; =1, Group control temperature effective is valid	
23	Static pressure positive compensation gear of DC fan	0~3 gears, the default is 0 gears, no compensation; The 3rd gear is the highest gear of static pressure, and the corresponding compensation speed is set for the 1 st to 3 rd gears in the indoor EE.	
24	Static pressure negative compensation gear of DC fan	0~3 gears, the default is 0 gears, no compensation; The 3rd gear is the lowest gear of static pressure, and the corresponding compensation speed is set for the 1 st to 3 rd gears in the indoor EE.	
25	Access control, fire protection, ON/OFF function set	=0, access control, fire protection functions are all invalid; =1, access control function is valid; =2, fire protection function is valid; =3, access control, fire protection are all valid; =4, ON/OFF function are all valid.	
28	Deep cool mode	0: Deep cool mode is invalid; 1: Deep cool mode is valid.	

3. Central Controller(YXE-C03U(E))

3.1 YXE-C03U(E) (Simplified central controller)

3.1.1 Function Introduction

Part Names

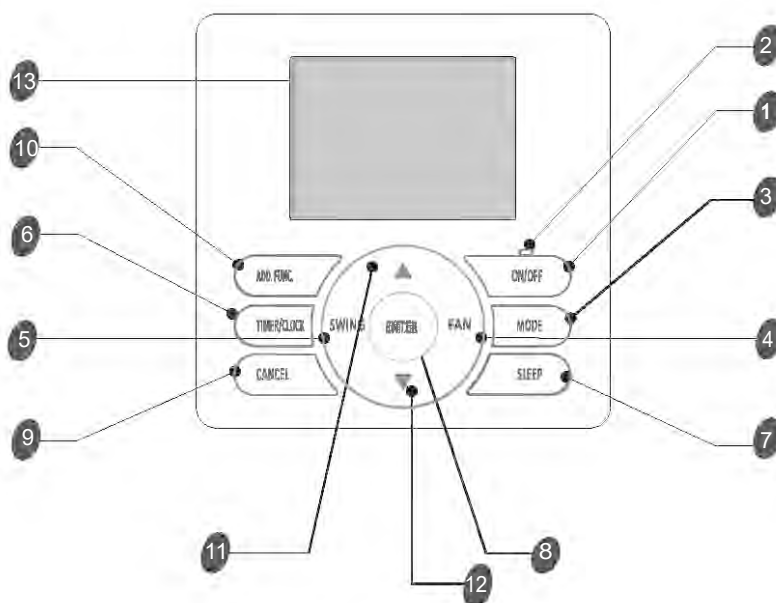

- 1 ON/OFF BUTTON**
The appliance will be started when it is energized or will be stopped when it is in operation, if you press this button.
- 2 RUN INDICATOR**
Indicates that the appliance is on.
- 3 MODE BUTTON**
Press this button to select the operation mode.
- 4 FAN BUTTON**
Used to select fan speed in sequence low-medium-high- auto-low.
- 5 SWING BUTTON (Invalid for some models)**
Used to stop or start adjustment louver swinging and set the desired airflow direction.
- 6 TIMER/CLOCK BUTTON**
Used to set the current time or set timer on/off.
- 7 SLEEP BUTTON**
Used to set or cancel Sleep Mode operation.
- 8 ENTER BUTTON**
Used to confirm settings.
- 9 CANCEL BUTTON**
Used to cancel settings.
- 10 ADD.FUNC. BUTTON**
Used to set filter clean, hot water, fresh air, electric heater, etc.
- 11 INCREASE SETTING BUTTON**
Used to raise the set temperature;
It changes the TIMER ON/OFF settings and WEEKLY TIMER settings.
- 12 DECREASE SETTING BUTTON**
Used to lower the set temperature;
It changes the TIMER ON/OFF settings and WEEKLY TIMER settings.
- 13 LIQUID CRYSTAL DISPLAY(LCD) SCREEN**
Used to display indicator screens.

3. Central Controller(YXE-C03U(E))

LCD Screen

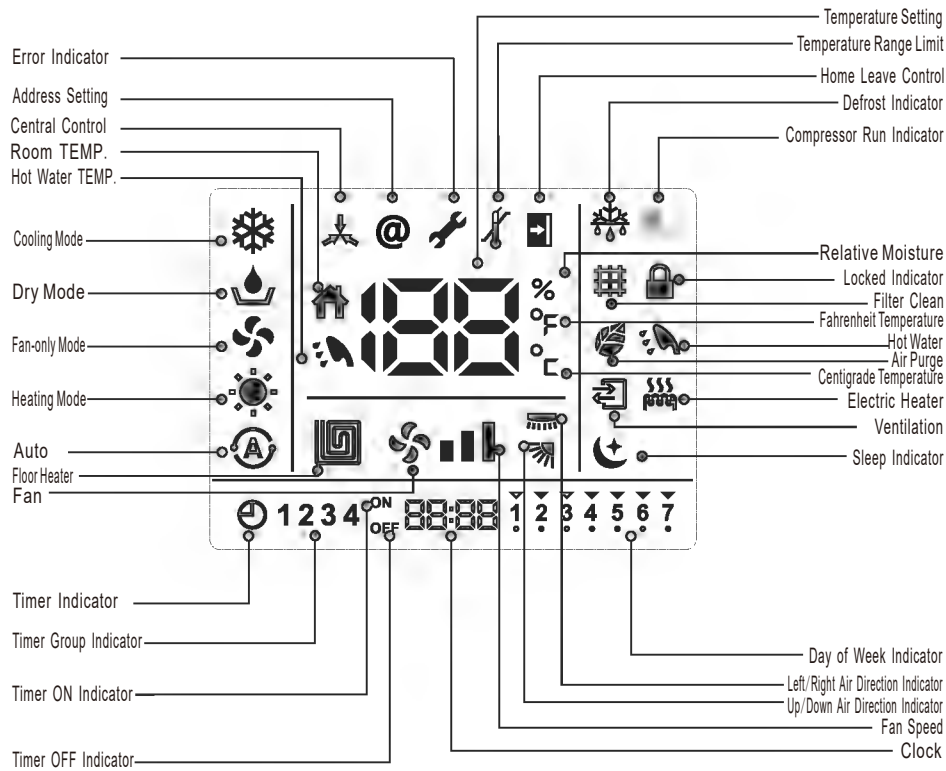

NOTE:

1. For purpose of explanation, all parts of the display are shown. During actual operation, only the relevant items will be displayed.
2. Heating and electric heating function are not available for single cooling only models.
3. Air direction, Filter Clean, Hot Water, Floor Heat, Filter Clean, Ventilation, Electric Heating, etc. are only effective for dedicated models. For details, please refer to the operation manual.
4. ERROR and Maintenance, Address Setting, Central Control, TEM. Range Limit, Fahrenheit Temperature should be set by the dealer.

3. Central Controller(YXE-C03U(E))

Simple Operation

This wired remote controller should be used with the air conditioner. It can be used for cooling, heating, dry and fan, etc. For other functions and settings, please refer to the specific operation in this manual.

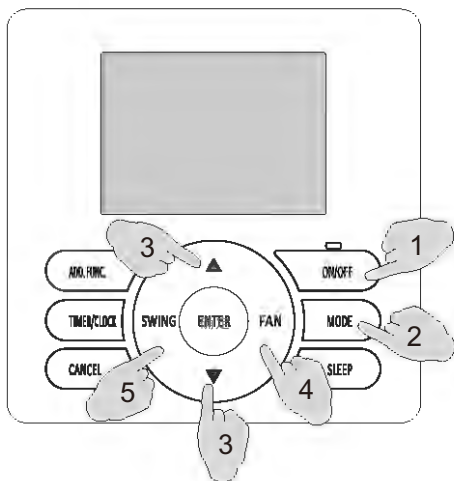

1. Turning ON/OFF

<To start operation>

Press the ON/OFF button, the ON lamp lights up, and the appliance will be started.

<To stop operation>

Press the ON/OFF button again, the ON lamp goes off, and the appliance will be stopped.

Hold down "ON/OFF" button for more than 3 seconds, the appliance will enter completely shutdown state.

(When the indoor unit stops, do not use timer ON to start, but start it manually), the buzzer beeps for 4 times.

2. Mode Setting

Press "MODE" button to select mode operation under shutdown state and no timer has been set. Each time MODE button is pressed, the operation mode changes in the sequence below:



NOTE:

AUTO mode is invalid for models without AUTO mode when setting.

HEATING mode is invalid for cooling only types or heating-forbidden air conditioners.

3. Temperature Setting

Under ON conditions or under OFF conditions where TIMER ON function is enabled, press "▲" or "▼" button to enter the temperature setting state.

Each time "▲" button is pressed, the temperature setting rises by 1°C;

Each time "▼" button is pressed, the temperature setting lowers by 1°C.

Setting temperature is finished 5 seconds after the set temperature value flickering.

Range of Temperature Setting	
HEATING, COOLING, DRY	16°C~30°C
FAN ONLY	Unavailable for setting

NOTE:

1. Heating mode is invalid for cooling-only air conditioners.

2. The default setting range depends on the indoor unit.

3. Setting range can be changed by professional stuff, and for detailed operations, please contact the installation service/after-sales service center.

4. When the set temperature reaches the upper or lower limits, "⚡" icon will display on the LCD, the set temperature will not rise or fall any more.

4. Fan Speed Setting

Under ON conditions or under OFF conditions where TIMER ON function is enabled, press the "FAN" button to adjust the fan speed. The fan speed will change in the following sequence:

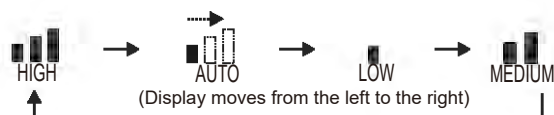

3. Central Controller(YXE-C03U(E))

5. Airflow Direction Setting

Under ON conditions or under OFF conditions where TIMER ON function is enabled, press the "SWING" button to adjust the airflow direction. The airflow direction setting will change in the following sequence by default.

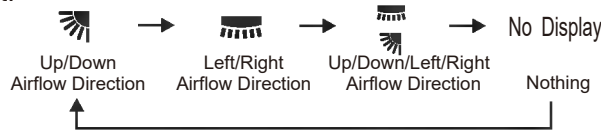

NOTE:

1. This function is only applicable to the air conditioning units with the swing function.
2. are only available for some models.

6. Display of the Number of Online Slaves

Hold down "ON/OFF" button for more than 3 seconds, and the appliance will enter completely shutdown state, central control indicator begins to light up, and it will display the number of online slaves.

Function Setting

Super

The maximum cooling/heating capacity can be realized in Super mode.

How to operate:

Press the "▲" button for 3s under ON conditions to go into Super mode, and the indoor unit will run at the ultrahigh fan speed.

The icon will flicker on the screen.

If you operate the super function in COOLING, DRY and FAN ONLY modes, the machine will automatically go into the forced cooling mode, and forced heating mode in the heating mode.

How to cancel:

Press the "ON/OFF"/"MODE"/"SLEEP"/"FAN" buttons to exit immediately.

NOTE:

For the indoor units without ultrahigh fan speed function, it will be adjusted to run at high fan speed in Super mode, with high fan speed mode icon displayed.

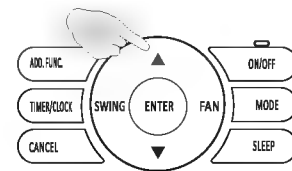

Mute

The mute running mode reduces the noise by changing the fan speed of indoor unit so as to keep quiet during working at night.

How to operate:

In COOLING/HEATING mode under ON conditions, press the "▼" button for 3s to enter the mute mode of indoor unit, and the indoor unit will run at the ultralow fan speed.

The icon will flicker on the screen.

How to cancel:

Press the "ON/OFF"/"MODE"/"SLEEP"/"FAN" buttons to exit immediately.

NOTE:

For the indoor units without ultralow fan speed function, it will be adjusted to run at low fan speed in the mute mode, with low fan speed mode icon displayed.

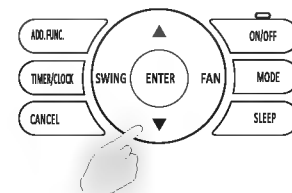

3. Central Controller(YXE-C03U(E))

Auxiliary Electric Heating

Under ON conditions or under OFF conditions where TIMER ON function is enabled, or when the air conditioner is in heating mode, press the "ADD.FUNC" button to manually select the auxiliary electric heating functions. When the auxiliary electric heating function is set to ON, the icon  will be on, and display the following contents as per the actual enablement conditions of auxiliary heating (auxiliary electric heating may not start because the internal conditions are not satisfied).

When the auxiliary electric heating function is set to OFF, the icon  will disappear, and the electric heating function will be turned off immediately.

NOTE:

1. This function is only available for air conditioners with auxiliary electric heating function, and only can be selected in heating mode.
2. If you do not manually set the auxiliary heating function, this function will automatically start or cancel as per the external environment temperature and other conditions by default.
3. The manual auxiliary heating setting will be cancelled after the operations such as mode switch, outage, ON/OFF, etc.

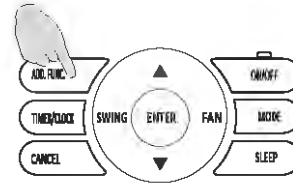

Sleep Mode

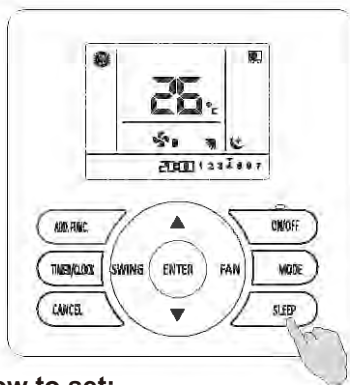

Before sleep, you can set the sleep function, then the air conditioner will run in the mode of comfortable sleep to make your sleep more comfortable.

How to set:

Press "SLEEP" button when the appliance is on,  will display on the LCD, then start SLEEP mode.

How to cancel:

Press "SLEEP" button again,  will disappear from the LCD, the SLEEP mode has been cancelled.

KNOWLEDGE:

If you want to change the OFF time during SLEEP mode, please set "TIMER OFF" in addition. For detailed operation, please refer to "TIMER OFF" setting.

NOTE:

The sleep function is not applicable in FAN ONLY mode and AUTO mode.

For some types of air conditioners, the set temperature value on display in sleep mode may not change along with the changing of the set temperature.

Button Locked

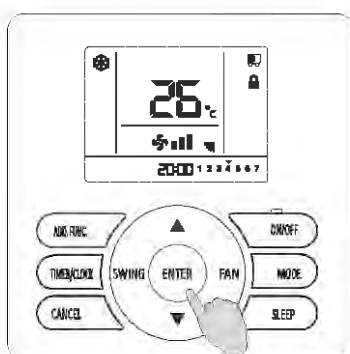

After the wired remote controller setting is completed, you can set button locked function to avoid children or others' wrong operation. All operations are invalid after button locked function has been set.

3. Central Controller(YXE-C03U(E))

How to set:

Hold down "ENTER" button for 3seconds, the buzzer beeps for 4 times indicating the setting is successively set and  displays on the LCD, indicating that the lock is now energized.

How to cancel:

Hold down "ENTER" button for 3 seconds, the buzzer beeps for 4 times indicating the setting is canceled and  disappears from the LCD, indicating that the button locked function has been cancelled.

Clock Setting

In case of any clock loss due to first startup and long-time shutdown, it is required to set the clock.

Setting method:

1. After startup, all indicators for days of the week and for the clock on the display screen flicker.
2. Press the "▲" and "▼" buttons to respectively adjust the set values of days of the week, hours, and minutes.
3. Press the "ENTER" button to confirm the setting, the indicators for days of the week, hours, and minutes stop flickering, and then the setting is completed.

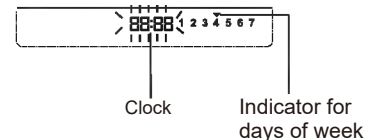

NOTE:

If you continuously press the ▲ / ▼ button, the time set value will increase or decrease rapidly.

Clock Correction

When the clock value is not consistent with the standard time, the clock shall be corrected.

Setting method:

Hold down the "ON/OFF" button for 3s, the wired remote controller will be shut down, and hold down the "TIMER/CLOCK" button for 3s again, it will go into the clock correction mode.

Adjust the clock in the following sequence:

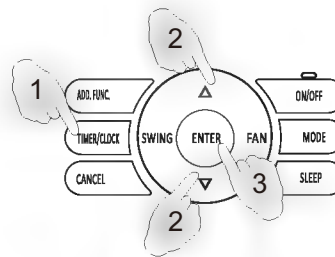

1. First, the cursor right above days of week will flicker, and then you can press the "▲" (plus button) and "▼" (minus button) to adjust the date to the required one, e.g., Thursday **1 2 3 4 5 6 7**, and press the "ENTER" button to confirm the settings.
2. Next, the hours setting icon **00:** will flicker in succession, and then you can press the "▲" (plus button) and "▼" (minus button) to adjust the hour to the required one, and press the "ENTER" button to confirm the settings.
3. At last, it proceeds to minutes setting in sequence (the setting method is the same to that for hours). The icons will stop flickering after the clock correction setting is completed.

NOTE:

If you continuously press the ▲ / ▼ button, the time setting value can be increased or decreased rapidly.

3. Central Controller(YXE-C03U(E))

Simple Timer ON (Invalid under weekly timer set)

Operation:

1. After you press “TIMER/CLOCK” button when the appliance is shut off,  and timer on indicator “ON” display on LCD, “ON” and timer hour setting flicker.
2. Press “▲” (plus) and “▼” (minus) button to adjust the time.
Each time “▲” button is pressed, time setting increases by 1h.
Each time “▼” button is pressed, time setting decreases by 1h.
It can be set from 1h to 24h, and time setting resolution is 1 hour.
3. Press “ENTER” button when reaching the desired time .
After operation, the display will be back to previous display before timer on setting, and “Timer” indicator appears on the bottom-left corner of the screen.
You can press the “CANCEL” button at any time to cancel the timer on setting and exit.
You can press the “TIMER/CLOCK” button to cancel the current setting and exit.

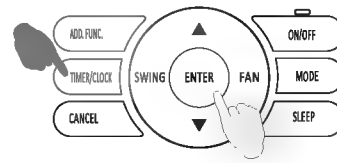

Simple TIMER ON inquiry

Press “TIMER/CLOCK” button again after TIMER ON has been set to display the rest of the time. As shown in the figure, it indicates that the appliance will be started after 58 minutes. 30s without any operation will quit query.

NOTE:

Simple timer only to be set in shutoff mode.

Simple Timer OFF (Invalid under weekly timer set)

Operation:

- 1 After you press “TIMER/CLOCK” button when the appliance is on,  and timer off indicator “OFF” display on LCD, “OFF” and timer hour setting flicker.
- 2 Press “▲” (plus) and “▼” (minus) button to adjust the time.
Each time “▲” button is pressed, time setting increases by 1h.
Each time “▼” button is pressed, time setting decreases by 1h.
It can be set from 1h to 24h, and time setting resolution is 1 hour.
- 3 Press “ENTER” button when reaching the desired time.
After operation, the display will be back to previous display before timer off setting, and “Timer” indicator appears on the bottom-left corner of the screen.

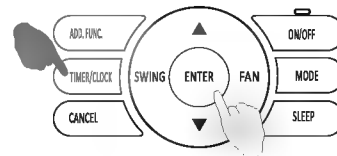

Simple TIMER ON inquiry

You can press the “CANCEL” button at any time to cancel the timer off setting and exit.

You can press the “TIMER” button to cancel the current setting and exit.

Press “TIMER/CLOCK” button again after TIMER OFF has been set to display the rest of the time.

As shown in the figure, it indicates that the appliance will turn off after 58 minutes.

30s without any operation will quit query.

NOTE:

The TIMER ON/OFF functions can not be set at the same time, if you need TIMER ON/OFF work in the future, please use WEEKLY TIMER function.

3. Central Controller(YXE-C03U(E))

Weekly Timer

Weekly timer can be used to set on/off time respectively for seven days a week. Air conditioner can be on/off in preset time every day, without manual control. The air conditioner can be on/off automatically before you wake up in the morning, back home from work or during sleep at night.

Weekly timer on/off time can be set for four groups at most, and the four groups can be assigned to any day regularly.

NOTE:

Please set the clock correctly before weekly timer setting.

Operation Procedure

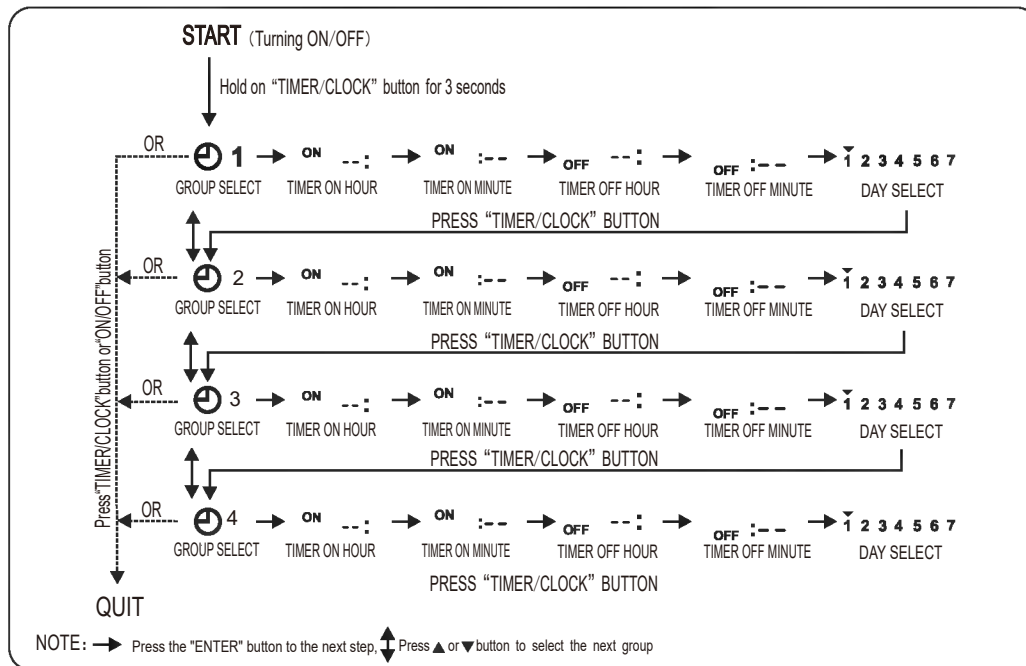

Weekly Timer Set Procedure

OPERATION:

1. Press “TIMER” button for 3 seconds to enter weekly timer setting inturning ON/OFF mode. appears on the LCD, group number flickers.

Follow the sequence below to the next setting:



First timer group number 1 blinks, press “ENTER” button, and enter Timer ON setting.

2. Timer on hour flickers, press “ \blacktriangle ”(plus) or “ \blacktriangledown ” (minus) to set the desired time.

Each time “ \blacktriangle ” button is pressed, time increases by 1hour;

Each time “ \blacktriangledown ” button is pressed, time decreases by 1hour.

After timer ON hour has been set, press “ENTER” button to return to timer ON minute setting.

If you continuously press the \blacktriangle / \blacktriangledown button the time set value will increase or decrease rapidly.

If you don't need timer OFF setting, press the “CANCEL” button to cancel.

3. Timer OFF setting is the same step with timer ON setting.

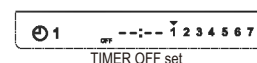
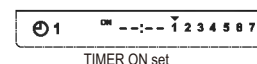
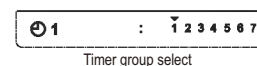
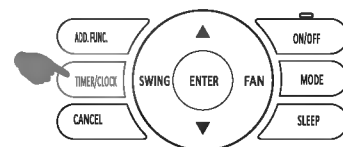

3. Central Controller(YXE-C03U(E))

4. After TIMER ON/OFF setting is completed, press “▲” (plus) or “▼” (minus) to select the desired day, press “ENTER” button to confirm it, or press “CANCEL” button to cancel. The selected day will be marked with “.”.

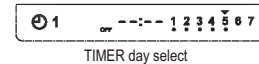

For example, 1 . 2 . 3 . 4 . 5 . 6 . 7 shows 7 days of a week all selected are effective.

- Continue group 2 setting, repeat the same setting procedure as group 1. Four groups timer ON/OFF can be set at most.
- You can quit WEEKLY TIMER setting by pressing “TIMER/CLOCK” or “ON/OFF” button when group number flickering.

Weekly timing inquiry

When the weekly TIMER function is available, it will go into the weekly timing inquiry if you press the “TIMER” button. Press the plus button “▲” or minus button “▼” to inquire the previous or the next timer moment.

NOTE:

If need to temporarily leave for a few days when weekly timer has been set, meanwhile timer ON/OFF is not permitted to work and continue to work after you are back, you can hold down “ON/OFF” button for 3 seconds to turn it off completely. At this moment, weekly timer set time can still be saved, but the air conditioner will not run.

Weekly timer setting resolution is 1 minute. Timer ON/OFF signal is effective within 1 minute.

Buzzer Indicator Selection

Default buzzer indicate during operation. If mute operation is needed, hold down “FAN” button for 3 seconds, the buzzer beeps for 4 times, indicating setting has been successfully changed. If you need it return to normal, repeat the steps above.

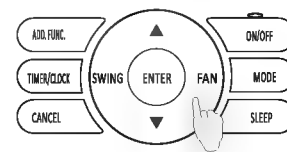

Dimmer setting

The screen is bright by default. If you need the screen to be dark, hold down “MODE” button for 3seconds, the buzzer beeps for 4 times indicating the setting has been successfully changed. If you need it return to normal, repeat the steps above.

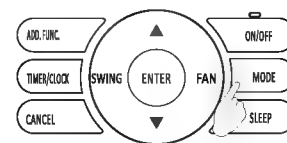

Filter clean resetting

(Available for models equipped with filter clean function and need operate by professional staff)

When # displays on LCD, it indicates that the filter needs to be cleaned.

Please contact professional stuff to do filter cleaning. After the cleaning, hold down “CANCEL” button for 3 seconds, the buzzer beeps for 4 times indicating FILTER CLEAN has been successfully reset.

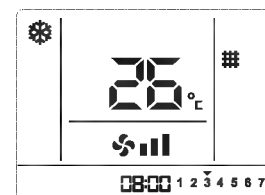

NOTE:

FILER CLEAN screen prompt is only effective for some models. For details, please refer to indoor unit manuals. Be sure to stop the operation and turn off the power supply before performing any cleaning.

3. Central Controller(YXE-C03U(E))

Maintenance

- Wipe the LCD or the body of the wired remote controller with a dry cloth when they become dirty.
- If the dirt on the surface cannot be removed, soak the cloth in neutral detergent diluted with water, squeeze the cloth tightly, and clean the surface. Wipe the surface with a dry cloth then.
- Do not use any thinner, organic solvents, or strong acid.

Troubleshooting and After-sales Service

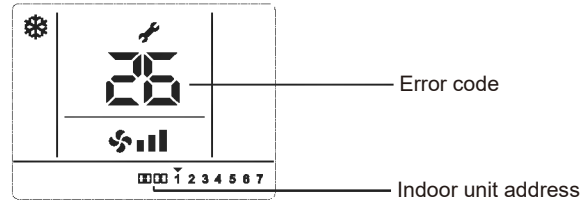

When the air conditioner malfunctions,  will display on the LCD of the wired controller, and error codes will appear, indicating that error occurs.

Please take note of the indicated error codes to contact the After-sales Service.

Consult the dealer for more information about the after-sales service.

3. Central Controller(YXE-C03U(E))





3.1.2 Installation Manual

① Safety Precautions

- Be sure to read safety precautions in the wired remote controller operation manual carefully before installation, and install it correctly.
- This wired controller applies to synchronize the multi-split air conditioning system.
The multi-split air conditioning system consists of an outdoor unit and multiple indoor units (up to three units), among which, one is the master and the other is the slave.
This controller only communicates with the master.

② Checking Accessories

Check the following accessories are included with the unit before installation:

Installation Manual	Operation Manual	Self-tapping Screw	Connection Wired
 (1 pc)	 (1 pc)	 (2 pcs)	 (1 pc)

③ How to Install

1. Selecting the Installation Location.
Please select the installation location according to **safety precautions** in operation manual.
2. Removing the upper cover of the wired controller.

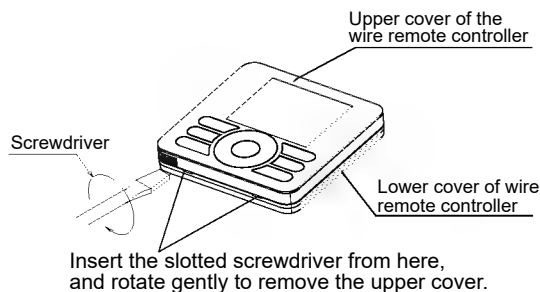

- NOTE:**
Control board of the wired controller is placed on the upper cover.
Please protect it from being scratched during removal and installation!

3. Wiring of the wired remote controller

① Leading out the wire

Pull the connection cord of the wired controller and communication line of central controller (if the central control function is necessary) out of the embedded terminal box (to be provided by users) and pass the line out of the rear cover of the wired controller for connecting them to the terminal block on the front cover of the wired controller, as shown in the figure below:

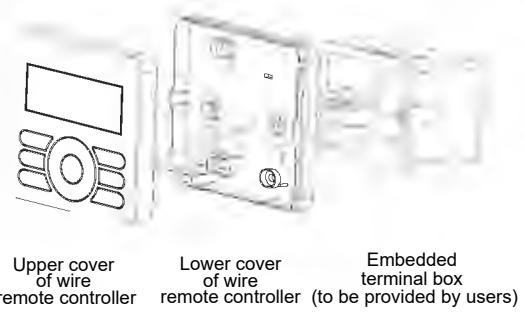

② Wiring

Communication wiring diagram

RS485 shielded twisted pairs (with polarity, A+ B-)



wired controller wiring diagram

Type of Communication Wire	Min. Specification
Shielded twisted pairs with polarity	Sectional area 2×0.75mm ²

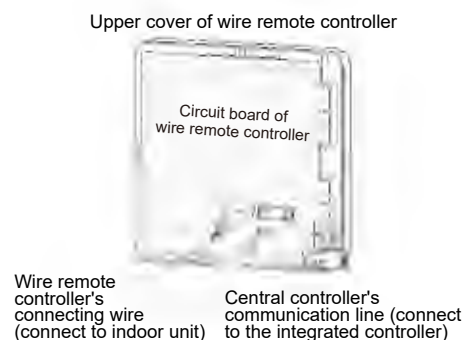

Terminal block for communication line

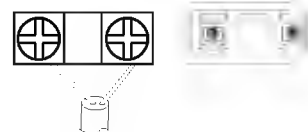

Notes for connection:

- ① Correct polarity of the communication line should be ensured during connection.
 - ② Loosen the wiring screws, completely insert the ends of the connecting conductor into the terminal block, and tighten the screws. Gently pull the conductor to confirm the connection cord has been tightly screwed.
- NOTE:** Firmly fasten the connection cord after connection.

3. Central Controller(YXE-C03U(E))

4. Securing the lower cover

Please secure the lower cover with the self-tapping screws (2 pcs) from the attachments.

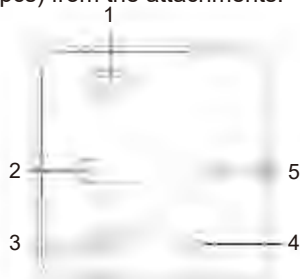

Standard embedded terminal box

Please align the screws with #1 and 3 holes or #1 and 4 holes.

Small-size embedded terminal box (86 type)

Please align the screws with #2 and 5 holes.

4 Well mounting the upper cover

Align the upper cover with the hasp of lower cover of the wired remote controller, and then press the upper cover onto the lower cover.

After installation, tear off the protective sticker attached on the wired controller.

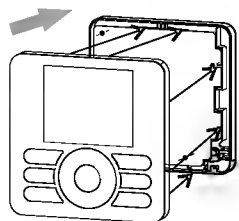

3. Central Controller(YXE-C03U(E))

3.1.3 Checking and Setting

Indoor Unit Parameter Checking

The internal parameters of the air conditioner can be read with the following method.

Instruction

1. Hold down Mode button and ADD. FUNC. button for 3s simultaneously to enter parameters customer-reading state, and then customer-reading parameter codes will display in the temperature display area. (See fig.1)

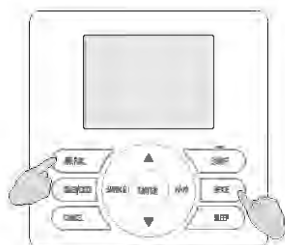

fig.1

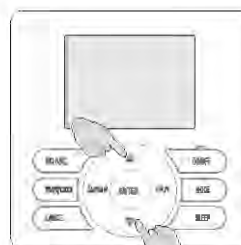

fig.2

2. Press Up or Down button to adjust to the customer-reading parameter code to read. For detailed information, please refer to Table 1. For example, the picture above means that it is a duct indoor unit. (See fig.2)

Table 1

Customer-Reading Parameter Code	Implication of Code Display	Description
01	Indoor unit kind	00H: Wall mounted; 01H: Ducted; 02H: Cassette; 03H: Ceiling & Floor; 04H: Floor Standing; 05H: ATW;
06	IDU environment temperature	°C
07	IDU coil temperature	°C
08	ODU environment temperature	°C
09	Discharge temperatur	°C
11	ODU coil temperature	°C
14	EEV step	
23	I feel temperature by wired controller	°C
24	Error code	
25	Sub-error code of driving board error E45	

3. Press ON/OFF button to quit customer-reading state. (see fig.3)

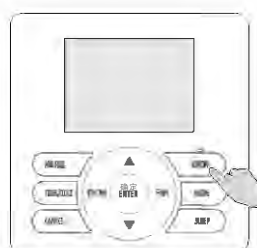



fig.3

3. Central Controller(YXE-C03U(E))

Indoor Unit Parameter Setting

The internal parameters of the air conditioner can be set with the following method.

Instruction

1. Hold down both MODE button and ADD. FUNC. button for 3s, symbol  and parameter number blinking at the same time. (see fig.4)

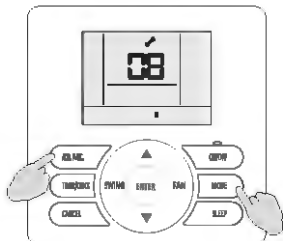

fig.4

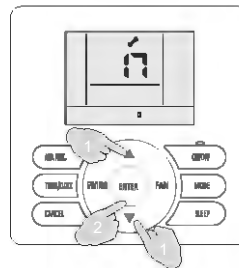









fig.5

2. Press  or , and the parameter code increases or decreases by 1 accordingly. When 17 displays, press ENTER button to rewrite EE parameter of the indoor unit, at the same time, the symbol  lights and EE parameter code 00 blinks.(see fig.5)
3. Press  or , and the EE parameter code increases or decreases by 1 accordingly and the corresponding value of EE displays in the Timer display area. When the EE code needs to be rewritten displays, press ENTER button to come to EE rewriting mode, at the same time the symbol  lights, EE parameter code lights and the value of EE blinks. For the EE parameter code, see Table 2.
4. When the value of EE blinks, press  or  to adjust it until the value needed displays, at this time, press ENTER button to save it. For example, the diagram above shows that when the parameter code is 1 (Self-recovery of power break), the function of self-recovery of power break can be realized.
5. Press ON/OFF button to quit to #17, press ON/OFF button again to exit from the parameter rewriting state.

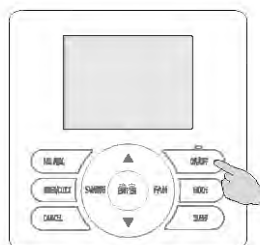

fig.5

3. Central Controller(YXE-C03U(E))

Table 2

Parameter code	Parameter Description	Parameter Value&Representation		NOTE
		Data Type	Representation(Function Code)	
1	Self recovery of power break	Integer	0: Cancel self recovery of power break function; 1: Self recovery of power break; others: invalid.	
2	Temperature type	Integer	0: Centigrade temperature; 1: Fahrenheit temperature; others: invalid.	
3	Temperature display type	Integer	0: Default display set temperature; 1: Default display room temperature; others: invalid.	
4	Ratio of ambient temperature sensed by indoor temperature sensor(cooling mode)	Integer	0~10valid, more than 10default is 10 0:0%; 1:10%;...; 10:100%	0:entirely use temperature sensed by wired remote controller; 10:entirely use temperature sensed by indoor unit
5	Filter clean indication	Integer	0: Default display set temperature 1: Default display room temperature others: invalid	
6	Filter clean time set	Integer	0~32, more than 32 default is 32*1000h	
7	Installation height compensation	Integer	0~10m, more than 10m default is 10. =0,1,2: no fan speed compensation =3:increase fan speed =4~10:increase more fan speed	
8	Cooling temperature compensation(indoor unit temperature sensor)	Integer	0: 0°C;1:-0.5°C;2:-1°C;3:-1.5°C;4:-2°C; 5:-2.5°C;6:-3.0°C;7:-3.5°C;8:-4°C;9:-4.5°C; 10:-5°C(the wired controller displays integer with symbol)	
9	Heating temperature compensation(indoor unit temperature sensor)	Integer	0: 0°C;1:-0.5°C;2:-1°C;3:-1.5°C;4:-2°C; 5:-2.5°C;6:-3.0°C;7:-3.5°C;8:-4°C;9:-4.5°C; 10:-5°C(the wired controller displays integer with symbol)	
10	Static pressure set	Integer	1~250, function code=static pressure more than the limit static pressure default the limit static pressure, default is 0(default static pressure, related to models)	Duct type(DC motor)
12	Ratio of temperature sensed by indoor temperature sensor(heating mode)	Integer	0~10valid, more than 10 default is 10 0:0%; 1:10%;...; 10:100%	0:entirely use temperature sensed by wired remote controller; 10:entirely use temperature sensed by indoor unit
13	Temperature adjustment-cooling	Character	-10~10°C (single character with symbol)	Temperature displayed on wired controller
14	Temperature adjustment-heating	Character	-10~10°C (single character with symbol)	Temperature displayed on wired controller
15	Access control, fire protection, ON/OFF function set	Integer	=0, access control, fire protection functions are all invalid; =1, access control function is valid; =2, fire protection function is valid; =3, access control, fire protection are all valid; =4, ON/OFF function are all valid.	

3. Central Controller(YXE-C03U(E))

Self-setting Parameters

The internal parameters of the wired controller can be set with the actual usage conditions. The catalogue of custom-setting parameters is shown as follows:

Self-setting Parameter Code	Implication of Code Display	Description	Remarks
01	Version No.		
03	boot	Restore factory default	
04	Integrated control Baud rate setting	0-9600bps;1-19200bps;2-38400bps;3-76800bps	
05	Is remote control/button operation setting permitted or not	0-Remote control/button permitted; 1-Remote control prohibited; 2-Button prohibited; 3-Remote control/button prohibited see the table3 on the right for more content	The factory setting defaults to 0
06	Temperature display setting	0-Display the set temperature; 1-Display the indoor environment temperature	
07	Fahrenheit degree display setting	0-Display in degree centigrade; 1-Display in Fahrenheit degree	
08	Cooling-only setting	0-Heat pump type air conditioner; 1-Cooling-only air conditioner	
10	Temperature limits revision setting	0-Not permitted; 1-Permitted	
11	Environment temperature revision setting	0-Not permitted; 1-Permitted	
13	Number of slaves	0-No slave; 1-One slave; 2-Three slaves; 3-Three slaves	The factory setting defaults to 1
14	Outdoor unit capacity	0-1-100W, 2-200W, N-N*100W, which automatically matches with the indoor unit capacity	The factory setting defaults to 0
15	The maximum allowable deviation of the master-slave coil	N-Deviation value.	The factory setting defaults to 20



Table 3

NO	Description
0	Remote control/button permitted
1	Remote control prohibited
2	Button prohibited
3	Remote control/button prohibited
5	Turning ON/OFF by remote control prohibited
13	Turning on by remote control & MODE setting prohibited
17	Temperature setting by remote control prohibited
21	Temperature setting by remote control prohibited & ON/OFF setting prohibited
25	Temperature setting by remote control prohibited & MODE setting prohibited
29	Temperature setting by remote control prohibited & MODE setting & ON/OFF setting prohibited
33	Fan speed setting prohibited
37	Fan speed & ON/OFF setting prohibited
41	Fan speed & MODE setting prohibited
45	Fan speed & MODE & ON/OFF setting prohibited
49	Fan speed & temperature setting prohibited
53	Fan speed & temperature & ON/OFF setting prohibited
57	Fan speed & temperature & MODE setting prohibited
61	Fan speed & temperature & MODE & ON/OFF setting prohibited
65	Swing setting prohibited
69	Swing & ON/OFF setting prohibited
73	Swing & MODE setting prohibited
77	Swing & MODE & ON/OFF setting prohibited
81	Swing & temperature setting prohibited
85	Swing & temperature & ON/OFF setting prohibited
89	Swing & temperature & MODE setting prohibited
93	Swing & temperature & MODE & ON/OFF setting prohibited
97	Fan speed & swing setting prohibited
101	Fan speed & swing & ON/OFF setting prohibited
105	Fan speed & swing & MODE setting prohibited
109	Fan speed & swing & ON/OFF & MODE setting prohibited
113	Fan speed & swing & temperature setting prohibited
117	Fan speed & swing & temperature & ON/OFF setting prohibited
121	Fan speed & swing & temperature & MODE setting prohibited
125	Fan speed & swing & temperature & ON/OFF & MODE setting prohibited

The method of setting the self-setting parameters

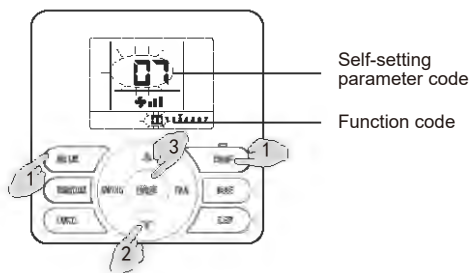

1. Hold down "ADD.FUNC" and "ON/OFF" buttons at the same time for 3s, the buzzer will beep for four times to alert that it goes into the parameter self-setting mode, and the screen will display the self-setting parameter code.
2. Press the "▲" button (plus) or "▼" button (minus) to adjust the self-setting parameter code that is required to be set, and press the "ENTER" button, with the function code displayed in flickering.
3. Press the "▲" (plus) button or "▼" (minus) button to adjust the function code, press the "ENTER" button to confirm the parameter, and then the setting is completed.

How to exit:

Press "Cancel" or "ON/OFF" button to exit when any self-setting code is displayed.

3. Central Controller(YXE-C03U(E))

Parameter Setting

1. Ambient Temperature Correction

(The adjustment can only be done when the environment temperature modification setting is available, and for details, see the part of **Self-setting parameters**.)

Setting of ambient temperature correction is for particular cases (e.g. installation location near the marble wall): wired remote controller is set to display ambient temperature, but the ambient temperature detected is different from the actual room temperature, and setting correction is necessary.

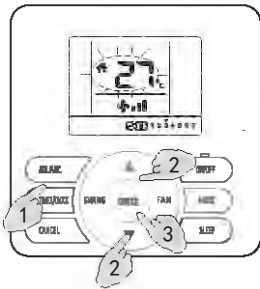

Ambient temperature correction

Setting method:

- Under OFF conditions, press the “▲” or “▼” button to display the icon.
- Hold down the “ADD.FUNC” for 3s, the buzzer will beep for four times to alert that it goes into the environment temperature modification state. The environment temperature value and environment temperature icon flicker at the same time.
- Press the “▲” (plus) button or “▼” (minus) button to adjust the environment temperature value within the range of $\pm 20^{\circ}\text{C}$ of the current temperature, press the “ENTER” button to confirm the setting, save the setting and exit.

How to cancel:

Under ambient temperature correction mode, press “CANCEL” button to cancel correction and exit.

Press any other button (except MODE button) to exit ambient temperature correction directly.

2. Temperature Limit Setting

Default temperature range is $(16-30)^{\circ}\text{C}$. You can change the range when needed.

For example, in cooling mode, temperature adjustment range could be changed to $(23-30)^{\circ}\text{C}$; in heating mode, it could be changed to $(16-23)^{\circ}\text{C}$. The temperature limit is only effective for the cooling and heating modes.

Setting method:

- If the temperature limit is allowed to be modified (for detailed operations, see **Self-setting parameters**), you can press the “▲” (plus button) or “▼” (minus button) to adjust the wire remote controller to display .
- Hold down the “ADD.FUNC” button for 3s, and the buzzer will beep four times to alert that it goes into the setting temperature limit state. The wire remote controller's limit temperature and limit temperature numerical value icons will flicker.
- Press the “▲” button (plus) or “▼” button (minus) to adjust the temperature limit value within the range of 18-32, and if you press the “MODE” button, it will change in the following sequence:



Press “ENTER” button to save the change and exit. After setting the limit temperature and limit temperature numerical value icons stop flickering.

How to cancel:

Under the state of temperature limit setting, press the “CANCEL” button to cancel setting and exit. Press any other button (except the MODE button) to exit from the temperature limit setting directly.

3. DIP switch setting

Please set the DIP code based on the practical situations, which will work if it is dialed before power on.

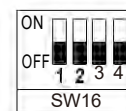

NOTE:

The symbol “■” represents the position where the DIP code locates.

Dial code	Dial content	Setting method
SW16-1	Terminal resistance setting	In order to guarantee the communication speed, it must be set as ON if being at the both ends of integrated control system.
SW16-2	Fuse short-circuit setting	After the fuse on electric control board blows, you can dial the dial code to ON to restore the integrated control communication.

3. Central Controller(YJE-C01T(E))

3.2 YJE-C01T(E)

3.2.1 System Introduction

The central controller is an optional control component for users to monitor and control operation of air conditioner in a centralized way.

The central controller can be used for unified management of the air conditioners in the group/zone, querying and displaying on LCD the state of the main functions of the air conditioner, weekly timer/simple timer setting or querying by keypad entry or setting of main functions of air conditioner.

Communicate with the indoor unit in the central control network

It can communicate with the wired controller/indoor unit through RS485 communication bus (shielded twisted pairs with polarity (A+ B-)). The indoor unit can be controlled centrally or locally by using the wired controller, or centrally controlled by using converter (to be purchased by users separately).

Control Diagram

1. Centrally or locally controlling the air conditioner using wired controller

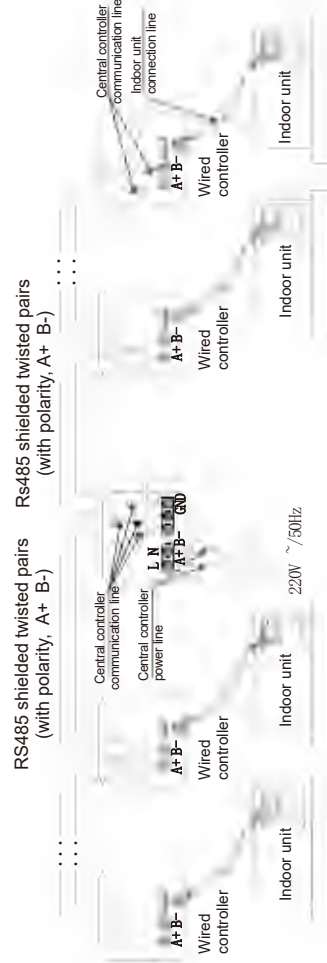

2. Centrally controlling the air conditioner using converter board

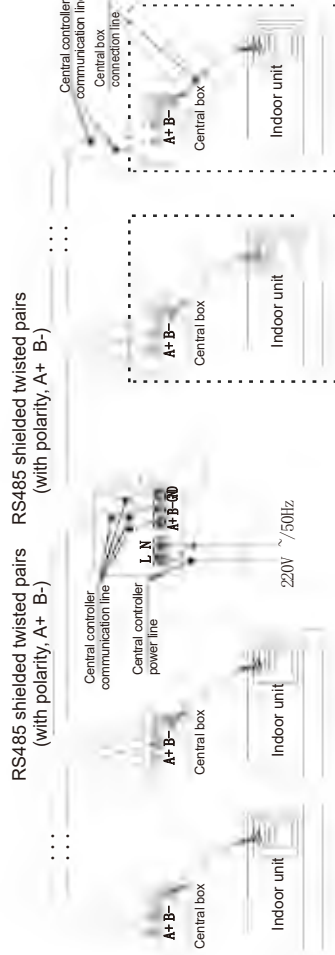

NOTE:

1. The central box needs to be purchased by users separately.
2. The wired controller/central box on either end of the central control system must be provided with terminal-matched resistor. See the installation instructions for the wired controller/central box for more details.

3. Central Controller(YJE-C01T(E))

3.2.2 Function Introduction

Part Names

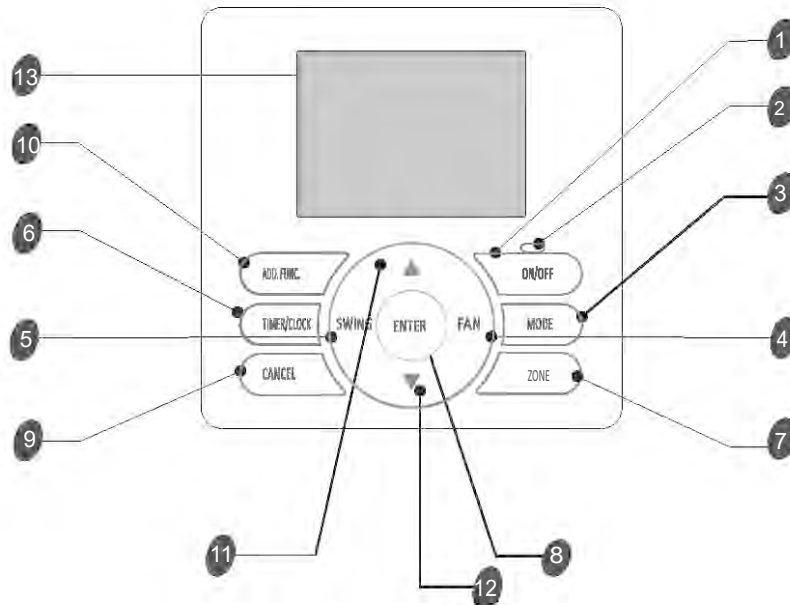

- 1 ON/OFF BUTTON**
The appliance will be started when you press this button and be stopped when you press this button again.
- 2 RUN INDICATOR**
Indicates that the appliance is on.
- 3 MODE BUTTON**
Press this button to select the operation mode.
- 4 FAN BUTTON**
Used to select desired fan speed in sequence low-medium-high-auto-low.
- 5 SWING BUTTON** (Invalid for models without louver)
Used to stop or start adjustment louver swinging and set the desired airflow direction.
- 6 TIMER/CLOCK BUTTON**
Used to set timer on/off and clock time.
- 7 ZONE BUTTON**
Used to set the group/zone.
- 8 ENTER BUTTON**
Used to confirm settings.
- 9 CANCEL BUTTON**
Used to cancel settings.
- 10 ADD.FUNC. BUTTON** (Only valid for models with addition function module)
Used to set functions of air purge, hot water, ventilation (fresh air) and electric heater.
- 11 INCREASE SETTING BUTTON**
Used to raise the set temperature. Settings can be raised in a setting state.
- 12 DECREASE SETTING BUTTON**
Used to lower the set temperature. Settings can be lowered in a setting state.
- 13 LIQUID CRYSTAL DISPLAY(LCD) SCREEN**
Used to display the icons of set functions.

3. Central Controller(YJE-C01T(E))

LCD screen

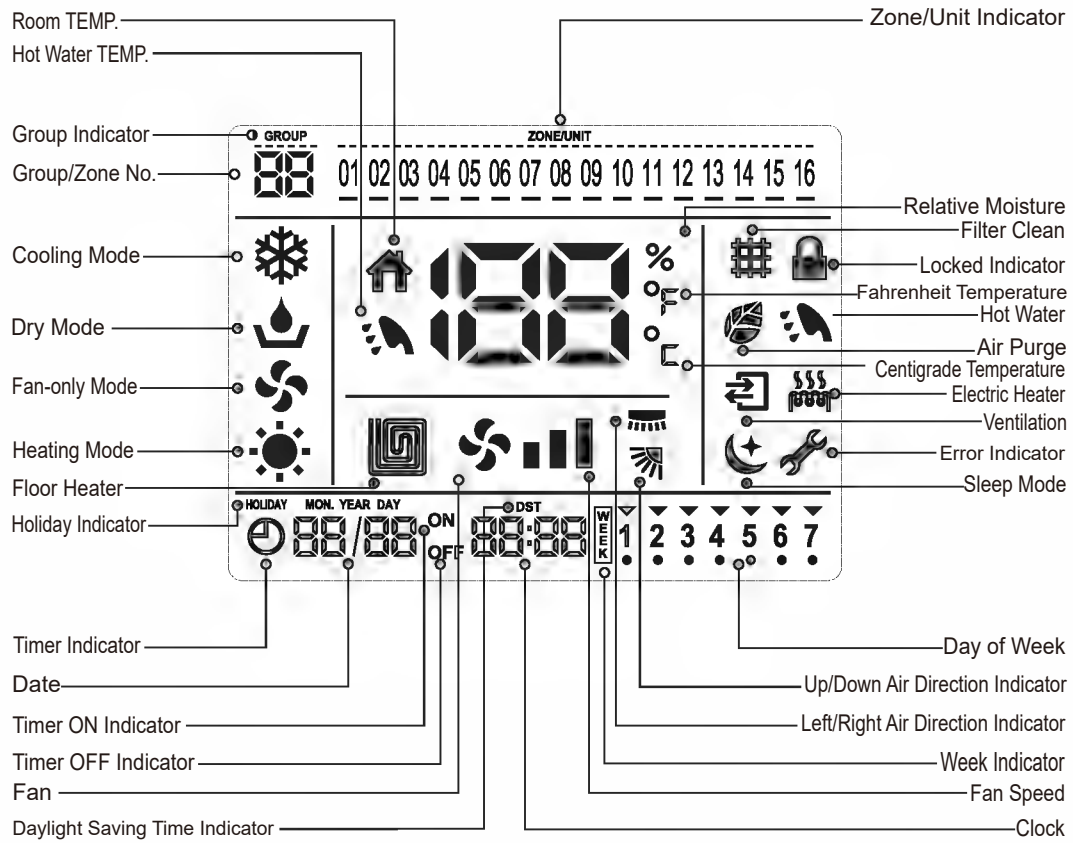

NOTE:

1. Heating and electric heating functions are not available for cooling only models.
2. Air direction, filter cleaning, hot water, floor heater, ventilation (fresh air), air purge, and electric heating functions are only effective for dedicated models, please refer to the operation manual of specific model for details.
3. Error and maintenance, address setting, and zone setting functions should be set by the professional personnel for installation and maintenance.

3. Central Controller(YJE-C01T(E))

Operation Modes of Central Controller

1. Group Control Mode (for the control of all conditioners in the central control network)
To control the air conditioners in the group in a unified manner.
2. Zone Control Mode
To control the air conditioners in the zone in a unified manner.

Before central control, group/zone settings must be carried out.

Group Setting

If the centralized controller at the next higher level is used, group setting needs to be carried out. The group number is only effective for the centralized controller.

All conditioners in the central control network can be classified into a range of group 1 to group 128.

Setting method:

Hold down "ADD. FUNC." button under shutdown state for 3 seconds to enter group setting, "GROUP" indicator and group number blink. Press "▲" or "▼" to select the group number. Press "ENTER" button to confirm the set group number, press "CANCEL" button to cancel.

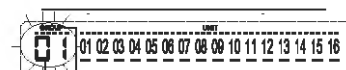
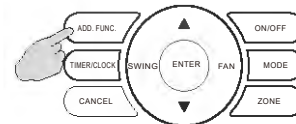

Group indicator number

Zone Setting

In a central control network, a maximum of 16 zones can be set. The same unit can be classified into different zones. A maximum of 16 air conditioners can be set in one zone.

1. Hold down "Zone" button for 3 seconds to enter zone setting, and the zone number blinks. Press "▲" or "▼" to select the zone number. Press "ENTER" button to enter setting of this zone.
2. Press "▲" or "▼" to select the air conditioner address numbers from 1 to 16, and the number blinks. Press "ENTER" button to confirm the selected number which is underlined. Press "CANCEL" button to cancel.
3. Press "Zone" button to enter setting of the next zone.
A maximum of 16 zones can be set.
4. Press "Zone" button again to exit the zone setting.

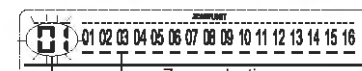
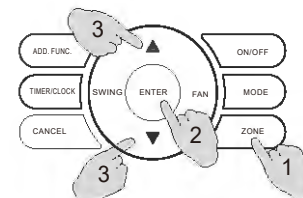

Zone selection
Zone Air conditioner
number address



Unit selection

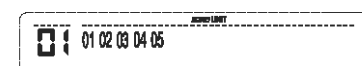

Setting completed

Group Control (Full Control)

1. After entering the group control mode, you can perform as follows:
Press "Group" button repeatedly until the group number and addresses of all air conditioners in the group are displayed on the central controller.
As shown in the right figure, the group number is 1, and there are 16 air conditioners in this group.
2. Unified function setting can be performed by other buttons (for detail description, please refer to instructions for specific operation procedure).



Full unified control

3. Central Controller(YJE-C01T(E))

Sub-zone Control

1. After entering the sub-zone control mode, you can perform as follows:

Press "Zone" button repeatedly until the number of the zone to be controlled and addresses of all air conditioners in the zone are displayed.

As shown in the right figure, the zone number is 1, and there are No.1, 2, and 3 air conditioners in this zone.

2. Function setting can be performed by other buttons (for detailed description, please refer to instructions for specific operation procedure).



Sub-zone control

Special Notes:

1. If no zone is set, only the group number will be displayed.
2. In the zone control mode, you can press "CANCEL" button to enter the group control mode.

Monitoring

After the central controller is started, the LCD on the central controller displays the operating state of the air conditioners in the network in turn if no other operation is carried out.

3. Central Controller(YJE-C01T(E))

Simple Operation

This central controller is used for unified cooling, heating, drying and air supply, etc. of the air conditioners in the group/zone. For other functions and settings, please refer to the details on the setting of functions in this manual.

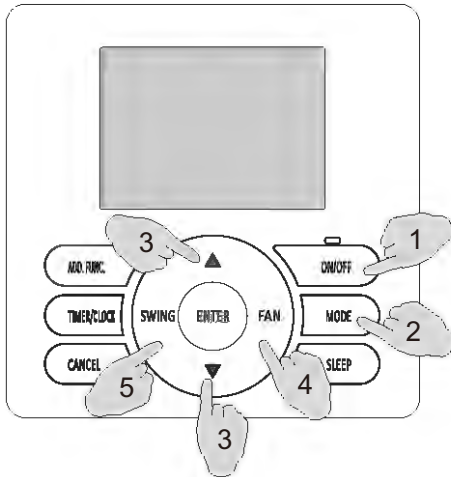

1. Turning ON/OFF

To start operation

When pressing the ON/OFF button in OFF state, the ON indicator lights up and the starting command will be sent to air conditioners in the group/zone.

To stop operation

When pressing the ON/OFF button in ON state, the ON indicator turns off and the shutdown command will be sent to air conditioner in the group/zone.

At this time, the set weekly timer ON (if any) will take effect.

To completely shut down

Hold down "ON/OFF" button for more than 3 seconds, the central controller will enter completely shutdown state (at this moment, the timer ON is disabled and the appliance only can be started manually), the ON indicator turns off, and shutdown command will be sent to air conditioners in the group/zone.

- 1. The ON/OFF button of central controller is only used to change the ON/OFF state of the air conditioners in the group/zone without affecting the other settings.
- 2. When the wired controller (if any) for the group/zone receives the shutdown command from the central controller, the appliance will enter completely shutdown state.

2. Mode Setting

Press "MODE" button to select the desired operation mode in ON state, or OFF state with timer set. Once the MODE button is pressed, the operation mode is changed in the sequence below:



3. Temperature setting

Press "▲" or "▼" button to set the desired temperature in ON state, or in OFF state with timer set. Then the temperature setting will blink on the LCD, indicating it entering setting mode.

Each time "▲" button is pressed, temperature setting rises by 1C.

Each time "▼" button is pressed, temperature setting lowers by 1C.

Setting temperature is finished 3 seconds after setting temperature value blinking.

Range of Temperature Setting	
*HEATING, COOLING, DRY	16°C~30°C
FAN ONLY	Unable to set

※:

- 1. Heating mode is unavailable for COOLING ONLY models.
- 2. When setting temperature is above setting range, "⚡" will display on the LCD, and setting temperature will not rise or lower any more.

4. Fan Speed Setting

Press "SPEED" button to select fan speed in ON state, or in OFF state with timer set. Each time "SPEED" button is pressed, the fan speed changes in the following sequence:

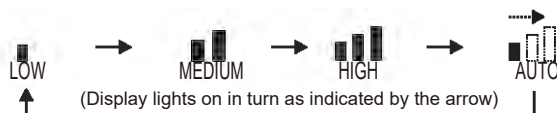

3. Central Controller(YJE-C01T(E))

5. SWING Setting

Press "SWING" button to select SWING in ON state, or in OFF state with timer set. Each time "SWING" button is pressed, the SWING changes in the following sequence.



NOTE:

1. This setting is only effective for units with this Swing function.
2. is only available for specific models.
3. In "DRY" mode, the fan speed is set to "AUTO" automatically and "FAN" button is ineffective in this case.

Function Setting

Clock

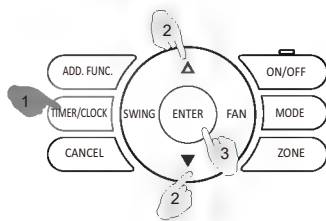
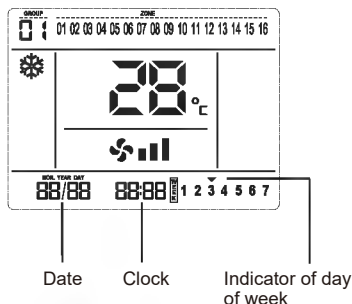

Using for the first time and clock loss caused by being unused for a long time, setting clock of central controller is needed at first.

How to set:

1. Indicators of date and day of week all blink after turning on.
2. Press "▲" and "▼" to set the current date, day of week, hour, minute in sequence. Press "ENTER" to confirm.

Clock Correction

Hold down "TIMER/CLOCK" button for 3 seconds under complete shutoff state to enter clock correction setting.

The settings of clock can be adjusted in the following sequence and the same method as clock setting.



After the adjustment is completed, press "ENTER" button to confirm the setting.

After the clock has been set, the central controller will display the current clock.

1. Clock correction should be set under complete shutoff state.
2. If there are two central controllers in the system, only the clock setting on the main central controller is effective.
3. Complete shutoff: When the unit is turned on, holding down "ON/OFF" button for 3 seconds will enter complete shutoff state.

Temporary shutoff: When the unit is turned on, press "ON/OFF" button to turn to temporary shutoff state. Shutoff state in this manual all means temporary shutoff.

Button Locked

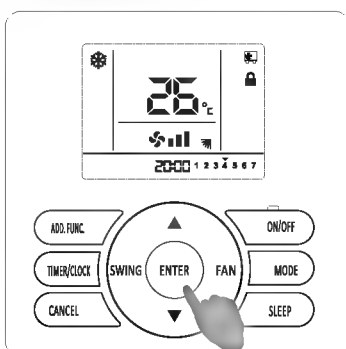

Button Locked

After central controller setting is finished, you can set button locked function to avoid children or other people's wrong operation.

All operations are invalid after button locked function has been set. After locking, the central controller still can operate normally. And unlocking can only be performed by the central controller.

How to set:

Hold down "ENTER" button for 3 seconds, the buzzer beeps for 4 times indicating the setting is successfully set and is displayed on the LCD, indicating that the wired controller is now under the button locked state.

3. Central Controller(YJE-C01T(E))

How to cancel:

Hold down “ENTER” button for 3 seconds, the buzzer beeps for 4 times indicating the setting is canceled and  disappears from the LCD, indicating that the button locked function has been canceled.

Simple Timer ON (Invalid under weekly timer setting)

Operation:

- 1 After you press TIMER/CLOCK button when the appliance is shut off,  and Timer ON indicator “ON” display on LCD, and timer hour setting blinks.
- 2 Press “▲” (plus) and “▼” (minus) button to adjust the time.
Each time “▲” button is pressed, time setting increases by 1h.
Each time “▼” button is pressed, time setting decreases by 1h.
It can be set from 1h to 24h, and time setting resolution is 1 hour.
- 3 Press “ENTER” button when the desired time is reached.
After operation, the display will be back to the previous display before TIMER ON setting, and “Timer” indicator appears on the left corner of the screen.

You can press the “CANCEL” button at any time to cancel the TIMER ON setting and exit.

You can press the “TIMER/CLOCK” button to cancel the current setting and exit.

Press “TIMER/CLOCK” button again after TIMER ON has been set to display the rest of the time.

As shown in the figure, it indicates that the appliance will be started after 58 minutes.

After the set time is reached, the air conditioners in the current group/zone will be turned on under unified control.

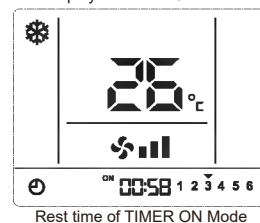
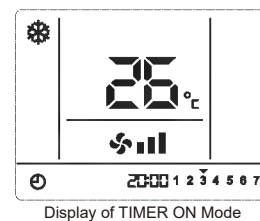
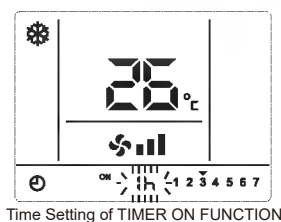
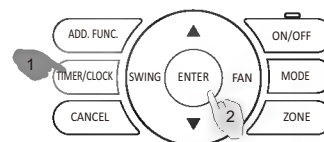

1. Simple TIMER ON FUNCTION only can be set in shutoff mode.
2. After time setting of TIMER ON FUNCTION, you can set/change mode, adjust temperature and fan speed, and set Swing mode (if any).
3. After the appliance is turned on, simple TIMER ON FUNCTION will be cancelled. If you need simple timer setting effective continuously, please set weekly timer.
4. Simple TIMER ON/OFF cannot be set simultaneously.
5. Simple TIMER ON setting is only effective for the current group/zone.

3. Central Controller(YJE-C01T(E))

Simple Timer OFF (Invalid under weekly timer setting)

Operation:

- 1 After you press TIMER/CLOCK button when the appliance is on,  and Timer OFF indicator "OFF" display on LCD, and timer hour setting blinks.
- 2 Press "▲" (plus) and "▼" (minus) button to adjust the time.
Each time "▲" button is pressed, time setting increases by 1h.
Each time "▼" button is pressed, time setting decreases by 1h.
It can be set from 1h to 24h, and time setting resolution is 1 hour.
- 3 Press "ENTER" button when the desired time is reached.
After operation, the display will be back to the previous display before Timer OFF setting, and "Timer" indicator appears on the left corner of the screen.

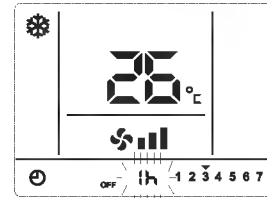
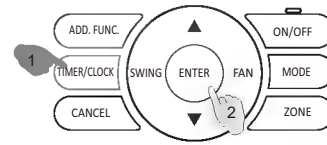

Time setting of TIMER OFF FUNCTION

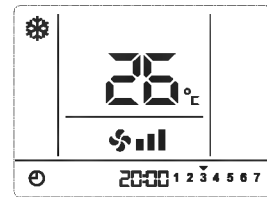

Display of TIMER OFF Mode

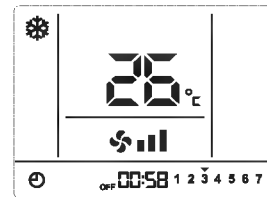

Rest time of TIMER OFF Mode

You can press the "CANCEL" button at any time to cancel the Timer OFF setting and exit.

You can press the "TIMER/CLOCK" button to cancel the current setting and exit.

Press "TIMER/CLOCK" button again after TIMER OFF has been set to display the rest of the time.

After the set time is reached, the air conditioners in the current group/zone will be turned off under unified control.



1. Simple TIMER OFF function only can be set in ON state.
2. After time setting of TIMER OFF FUNCTION, you can set/change mode, adjust temperature and fan speed, and set Swing mode (if any).
3. After the appliance is off, simple TIMER OFF FUNCTION will be cancelled. If you need simple timer setting effective continuously, please set weekly timer.
4. Simple TIMER ON/OFF cannot be set simultaneously.
5. Simple TIMER OFF setting is only effective for the current group/zone.

3. Central Controller(YJE-C01T(E))

Weekly Schedule

Weekly timer can be used to set on/off time respectively for seven days a week. Air conditioner can be on/off in preset time every day, without manual control. The air conditioner can be on/off automatically before you wake up in the morning, back home from work or during sleep at night.

Weekly timer on/off time can be set for four groups at most. The four groups can be assigned to any day regularly.

NOTE:

Please set the clock correctly before weekly timer setting.

Operation Procedure

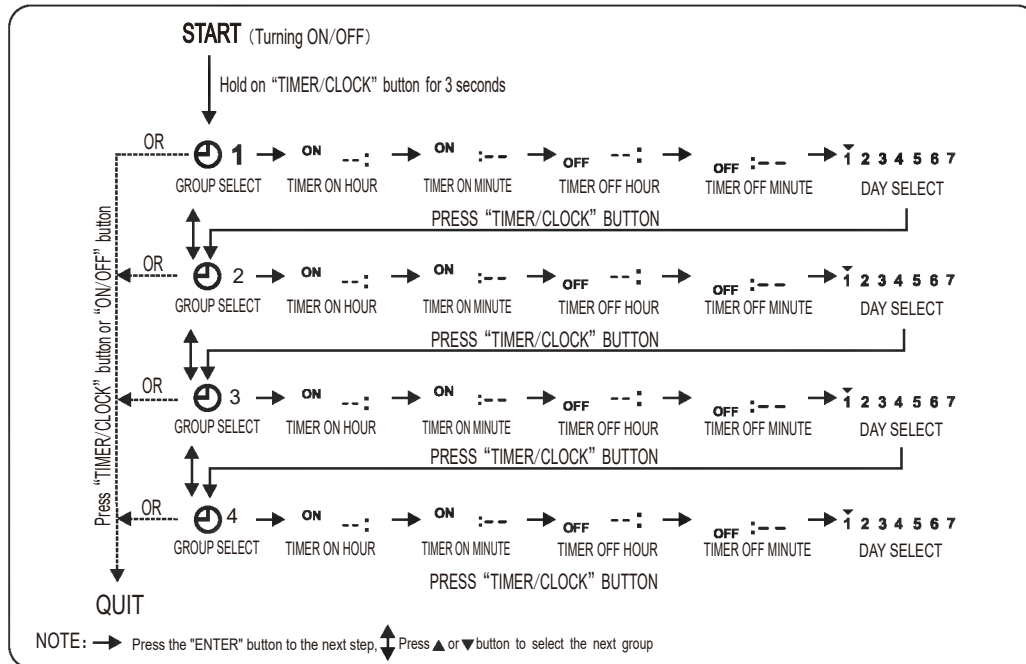

Weekly Timer Set Procedure

OPERATION:

1. Hold down "TIMER/CLOCK" button for 3 seconds to enter weekly timer setting in ON/OFF state. Then 1 appears on the LCD, and group number blinks.

Perform further settings in the following sequence:



First timer group number 1 blinks, then press "ENTER" button to enter Timer ON setting.

2. Timer ON hour blinks, then press "▲" (plus) or "▼" (minus) to set the desired time.

Each time "▲" button is pressed, time increases by 1h.

Each time "▼" button is pressed, time decreases by 1h.

After Timer ON hour has been set, press "ENTER" button to return to Timer ON minute setting.

If you don't need Timer ON/OFF setting, press the "CANCEL" button to cancel.

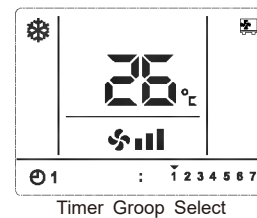
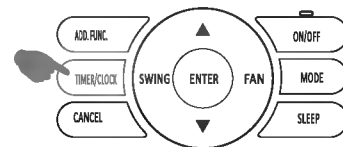

3. Central Controller(YJE-C01T(E))

3. Timer OFF setting can be performed in the same procedure with timer ON setting.
 4. After TIMER ON/OFF setting is completed, press “▲” (plus) or “▼”(minus) to select desired day, press “ENTER” button to confirm it, or press “CANCEL” button to cancel. The selected day will be marked with “.”.
- For example, **1 . 2 3 4 5 6 7** shows 7 days of a week all selected are effective.
5. After the setting of seven days a week is completed, proceed to the setting for group 2, which can be performed in the same setting procedure as group 1. Four groups can be set at most.
 - 6 You can quit WEEKLY TIMER setting by pressing “TIMER/CLOCK” or “ON/OFF” button in the group selection mode.

Checking the current weekly timer setting

Press “TIMER/CLOCK” button to check WEEKLY TIMER setting in this mode.

Press “▲” (plus) or “▼” (minus) button to check the previous or next set time.

You can press “TIMER/CLOCK” button under checking state to quit checking of WEEKLY TIMER.

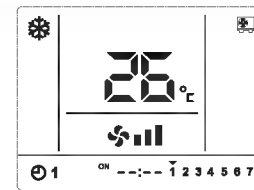

Timer ON Setting

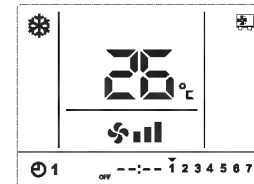

Timer OFF Setting

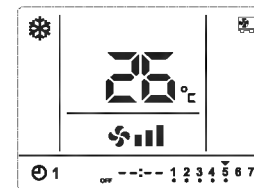

Timer Day Select



If you need to temporarily leave for a few days when weekly timer has been set, meanwhile timer ON/OFF is not permitted to work and continue to work after you are back, you can hold down “ON/OFF” button for 3 seconds to turn it off completely. At this moment, weekly timer set time can still be saved, but air conditioner will not run. Weekly timer setting resolution is 1 minute. Timer ON/OFF signal is effective within 1 minute.

Temperature Display Setting

Default display: set temperature

If you need to display room temperature, press “▲” button and “ENTER” button simultaneously for 3 seconds. Then the buzzer beeps for 4 times indicating setting has been changed. Then  appears on the LCD, indicating that the temperature shown on LCD is room temperature.

If you need to cancel setting, press “▼” button and “ENTER” button simultaneously for 3 seconds. Then  disappears on the LCD, indicating that the temperature shown on LCD is the set temperature.

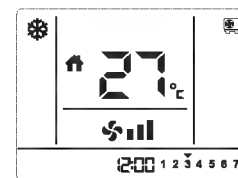
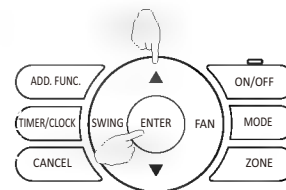

Buzzer Indicator Selection

The buzzer beeps during operation by default. If you need mute operation, hold down “FAN” button for 3 seconds, and the buzzer beeps for 4 times indicating setting has been successfully changed.

If you need to return to defaulted setting, repeat the steps above.

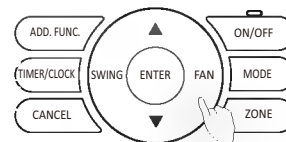

Backlight Selection

The backlight of the screen lights up during operation by default. If you need to turn off the backlight, hold down “MODE” button for 3 seconds and the buzzer beeps for 4 times indicating setting has been successfully changed.

If you need to return to defaulted setting, repeat the steps above.

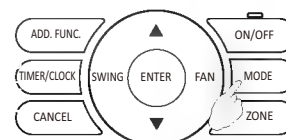



3. Central Controller(YJE-C01T(E))

Maintenance

- Wipe the LCD of central controller and body of the wired controller with a dry cloth when they become dirty.
- If the dirt on the surface cannot be removed, soak the cloth in neutral detergent diluted with water, squeeze the cloth tightly, and clean the surface. Wipe the surface with a dry cloth then.
- Do not use any thinner, organic solvents, or strong acid.

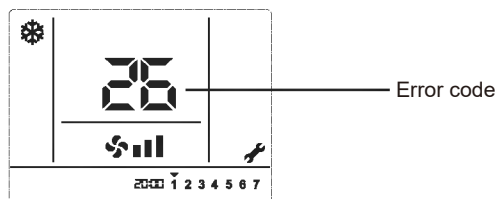
Troubleshooting and After-sales Service



When the air conditioner malfunctions,  will display on the LCD of the wired controller, and error codes will appear, indicating that error occurs.



- Please take note of the indicated error codes to contact the After-sales Service.
- Consult the dealer for more information about the after-sales service.

3. Central Controller(YJE-C01T(E))

3.2.3 Installation Manual

① Important Notice



Please read the Important Notice in these Installation Instructions supplied with the central controller, and perform installation in accordance with these instructions properly.

1. Complete information for the design planning, installation, commissioning, and after-sales services of the central control system must be documented and archived for future reference.
2. Design planning of the central control system should be planned in advance, including:
 - (1) Composition of the central control system and quantity of controls;
 - (2) Selection and installation position of the wired controller, electrical distribution and wiring, assignment of addresses, and connection with controller;
 - (3) Installation position of central controller, setting of primary and secondary central controllers, electrical distribution and wiring, and connection with the wired controller;
 - (4) Installation and wiring of the central control system, limitation on bus length, terminal-matched resistor at either end of the bus, single-point grounding of the shielding layer of the bus.
3. Notes
 - (1) Cables for central control and distribution lines shall not be too close to each other or routed in the same conduit. RS485 bus should be arranged as far away from interference sources as possible, especially high voltage interference sources, such as transformer and frequency converter. For other relevant precautions, see the requirements for wiring of building automation system;
 - (2) The total length of the central control bus should not be more than 1000m (at the baud rate of 9600 bps);
 - (3) The appliance on either end of the central control bus must be provided with terminal-matched resistor. See the DIP switch setting instructions for central controller/wired controller/central box;
 - (4) It is recommended that single-point grounding of the shielded cable shall be arranged in the middle of communication bus and close to the central controller;
 - (5) Central control line topology should be daisy-chain bus arrangement. If star topology or tree topology is required, it is recommended that 485 concentrators and 485 repeaters be used.
4. The wiring and installation of the central control network should be performed along with the installation and commissioning of air conditioner. Test run should be performed before installation.

5. The primary and secondary controllers can be set to operate at the same time in one central control system with at least one controller as the primary central controller.

② Checking Accessories

Check and confirm that in addition to the wired controller, the following accessories are included in the packaging box:

Installation Instructions	Operation Instructions	Screw
 (1pc)	 (1pc)	 (2 pcs)

③ How to Install

1. Selecting the location where the central controller is to be installed.

Select the installation location according to the Important Notice in these Installation Instructions.

2. Removing the upper cover of the central controller.

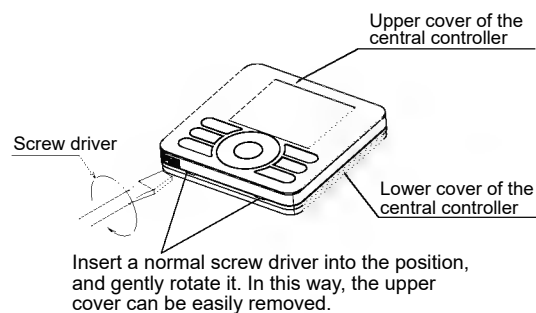

3. Connecting the central controller

① Leading-out line

Pull the power supply line of the central controller and central control communication line out of the embedded terminal box (to be provided by users) for connecting them to the terminal block on the rear cover of the central controller, as shown in the figure below:

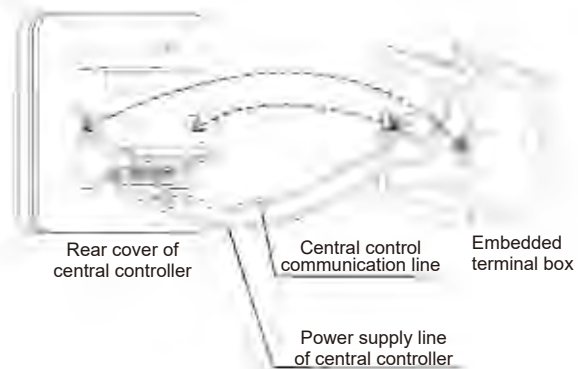

3. Central Controller(YJE-C01T(E))

② Connections

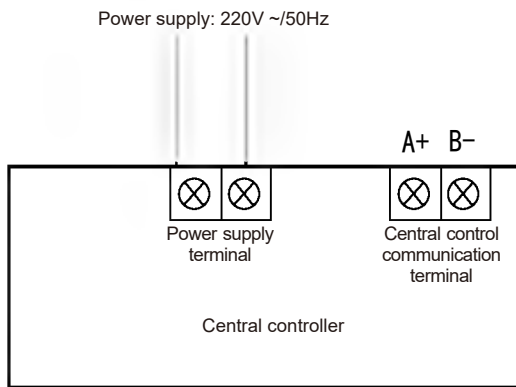

	Type	Minimum Specifications
Power supply line of central controller	Copper core wire	Cross-sectional area: 2×0.75mm ²
Central control communication line	Shielded twisted pairs	Cross-sectional area: 2×0.75mm ²

NOTE:

1. The requirement for wiring is the minimum;
2. Both the power supply line and communication line should be provided by users;
3. Correct polarity of the communication line should be ensured during connection;
4. The connecting cord should be reliably secured after connection is completed.

4. Securing the lower cover

Install the lower cover onto the embedded terminal box (filed-supplied). Please use the two screws to be supplied as accessories to secure the lower cover.

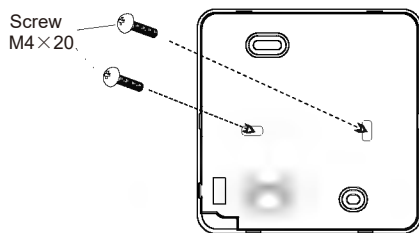

Standard embedded terminal box (86 type)

④ Setting DIP Switches

Default setting:

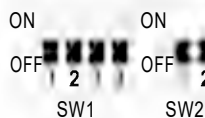

NOTE:

Symbol "■" indicates the position of the DIP switch.

DIP Switch	Description	Setting Method
SW1	Address settings	In the same central control system, 1. Addresses should not be repeated; 2. Settings can be made for both primary and secondary central controllers. The primary controller has the priority and its position must be set to "OFF".
SW2	Setting for terminal resistor	Be sure to set the position of the switch at "ON" on either end of the central control system; SW2-1: for central control system; SW2-2 for central management system

⑤ Setting Baud Rate

The default code for baud rate is 00, which supports the communication in a distance of no more than 1000m. As communication lines for different central control systems are different, the code for baud rate needs to be changed to ensure the transmission rate.

Setting methods:

1. Hold down "ADD.FUNC." button and "ON/OFF" button for 3 seconds and the buzzer beeps for four times indicating that the system enters a self-checking state. Press "▲" (plus) button to select the series number 4 and press "ENTER" button to confirm. Then the baud rate code below blinks indicating that the code can be set.
2. Press "▲" (plus) or "▼" (minus) to select proper code according to the communication requirement for the central control system.

Baud Rate Code	Baud Rate (bps)	Supported Maximum Communication Distance (m)
00	9600	1000
01	19200	400
02	38400	200

3. After the code value is changed, press "ENTER" button to complete the setting.

NOTE:

The baud rate of the central controller and that of the wired controller/contral box in the central control network must be the same.

Otherwise, the system will fail to operate properly.

3. Central Controller(YJE-C01T(E))

6 Resetting the System

Resetting Method:

Hold down “ADD.FUNC.” button and “ON/OFF” button for 3 seconds and the buzzer beeps for four times indicating that the system enters a self-checking state. Press “▲” (plus) button to select the series number 3 and press “ENTER” button. When indicator showing “boot” blinks in LCD screen, press the “ENTER” button to reset the system, then all system settings except those for DIP switches are restored to factory settings.

7 Snapping Upper Cover into Place

Align the upper cover with the corner buckles of the lower cover of the central controller, and press them together until the upper cover snaps into place.

After installation, please remove the protective sticker on the central controller.

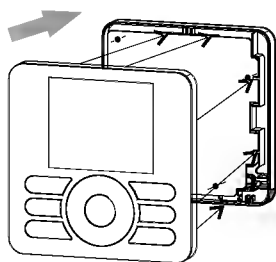

AFTER-SALE SERVICE

Contact the service shop where you bought the wired controller.

4. Control Box(B541(E))

4.1 Central Control Box(B541(E))

① Important Notice

Please read the Important Notice in these Installation Instructions supplied with the central control box, and perform installation in accordance with these instructions properly.

The central control box is a dedicated device that can be directly connected with the indoor unit for converting communication protocols and connects the indoor unit to central control network.
 Precautions for arrangement of central control system

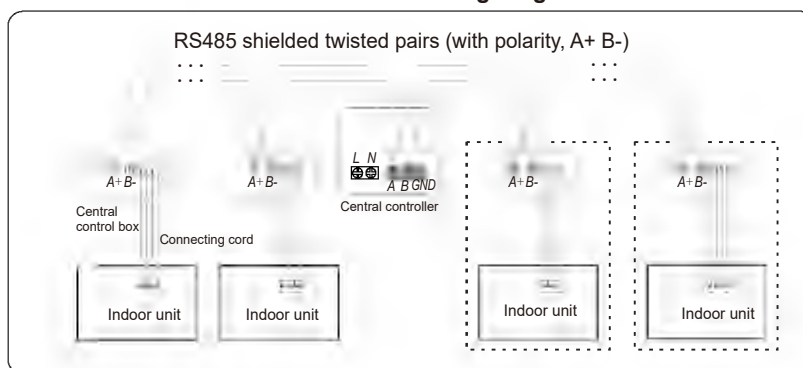

1. The design and installation of the central control box should be performed under the unified planning for central control system. The installation location of the central box, electrical distribution and wiring, address assignment, connection with central controller and indoor unit should be planned in advance.
2. Cables for central control and distribution lines shall not be too close to each other or routed in the same conduit. RS485 bus should be arranged as far away from interference sources as possible, especially high voltage interference sources, such as transformer and frequency converter. For other relevant precautions, see the requirements for wiring of building automation system.
3. The equipment on either end of the central control bus must be provided with terminal-matched resistor.
4. Central control line topology should be daisy-chain bus arrangement. If star topology or tree topology is required, it is recommended that 485 concentrators and 485 repeaters should be used.
5. The central control box should be installed close to the electronic control box of the indoor unit.
6. The baud rate configured for the central control box must be the same with that of the central controller.
7. The addresses for the central control box should not be repeated.

Central Control Box Wiring Diagram



② Checking Accessories

Check and confirm that in addition to the central control box product, the following accessories are included in the packaging box.

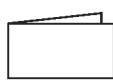
Installation Instructions	Connecting Cord	Clamp	Double-faced Adhesive Tape
 Qty.: 1	 Qty.: 1	 Qty.: 2	 Qty.: 1

③ How to Install

1. Selecting the location where the central control box is to be installed.

Please install it in the ceiling and close to the electronic control box of the indoor unit.

2. Connecting the central control box

① Connecting with the indoor unit by the communication line.

Connect the central control box with the indoor unit using the connecting cord supplied with the equipment, as shown in Figure 1. To prevent looseness of connector due to tensioning, use the line buckle (to be supplied with the equipment) to bind connecting cord, and fasten it to the hook, as shown in fig. 1.

4. Control Box(B541(E))

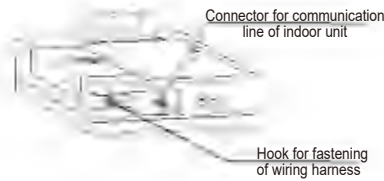

fig. 1 Connection with indoor unit by communication line

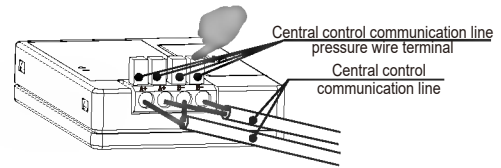

fig. 2 Connection of central control communication line

② Connection of central control communication line.

As shown in fig. 2, press the connection terminal for central control and insert the communication line for central control into the connecting hole. Then release the terminal until the communication line is properly inserted.

	Type	Minimum Specifications
Central control communication line	Shielded twisted pairs	Cross-sectional area: $2 \times 0.75 \text{ mm}^2$

NOTE:

1. The above requirement for wiring is the minimum;
2. The central control communication line should be provided by users;
3. Correct polarity of the communication line should be ensured during connection;
4. The connecting cord should be reliably secured after connection is completed.

3. Setting of DIP Switches

Please set DIP switches according to the actual conditions. Settings after power on will not take effect.

Methods for setting DIP switches:

Before setting, slide down the cover on the central control box to set the DIP switches.

After setting, reinstall the cover to the central control box.



Fig. 3 Methods for setting DIP switches

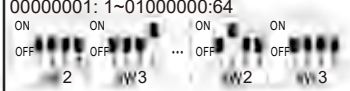
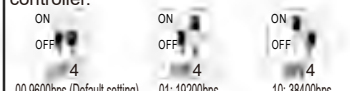

NOTE:
Symbol "■" indicates the position of the DIP switch.
Please refer to Table2 for the figure fo Address 1~16.

DIP Switch	Description	Setting Method
SW1-1	Setting when fuse operates	Set the position of the switch to "ON" when the fuse on the electronic control board of central control box operates to disconnect the circuit so as to restore the fuse.
SW1-2	Setting for terminal resistor	Be sure to set the position of the switch on either end of the central control system to "ON".
SW2 SW3	Setting of addresses	SW2: for setting high address (when more than 16 indoor units are used); SW3: for setting low addresses. Range of addresses: 1-64 00000001(address:1) 01000000(address:64) 
SW4	Setting of baud rate	00 9600bps (by default), 01: 19200bps, 10: 38400bps Baud rate should be the same with the central controller. 

4. Securing the central control box

If necessary, use double-faced adhesive tape to secure the central control box onto the indoor unit after installation.

4. Control Box(B541(E))

Table 1 DIP Switch Setting

Address No.	Example	Remarks
01		—
02		—
03		—
04		—
05		—
06		—
07		—
08		—
09		—
10		—
11		—
12		—
13		—
14		—
15		—
16		—

4. Control Box(B542(E))

4.2 Central Control Box(B542(E))

① Important Notice

Please read the Important Notice in these Installation Instructions supplied with the central control box, and perform installation in accordance with these instructions properly.

The communication box is a device specially intended to directly connect the indoor unit, which can have access to the multi-split system network by communication protocol conversion.

Precautions for arrangement of synchronize the multi-split air conditioning system.

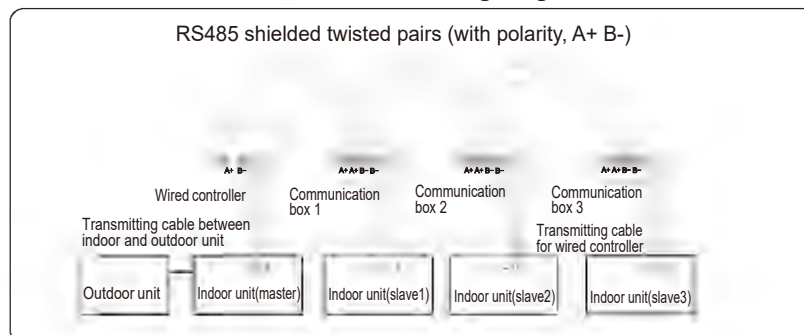

1. The design and installation should be performed under the unified planning for central control system. The installation location of the communication box, electrical distribution and wiring, address assignment, connection with central controller and indoor unit should be planned in advance.
2. Cables for central control and distribution lines shall not be too close to each other or routed in the same conduit. RS485 bus should be arranged as far away from interference sources as possible, especially high voltage interference sources, such as transformer and frequency converter. For other relevant precautions, see the requirements for wiring of building automation system.
3. The equipment on either end of the central control bus must be provided with terminal-matched resistor.
4. The RS485 line must be configured as a daisy-chain bus topology. If a star-type or tree topology is required, it is recommended to use RS-485 hub and RS-485 repeater.
5. The communication control box should be installed close to the electronic control box of the indoor unit.
6. The baud rate of the communication box must be set to 9600 bps, i.e., SW4 is set to 00.
7. The addresses for the communication control box should not be repeated.

Central Control Box Wiring Diagram



② Checking Accessories

Check and confirm that in addition to the communication box product, the following accessories are included in the packaging box.

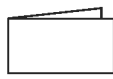
Installation Instructions	Connecting Cord	Clamp	Double-faced Adhesive Tape
 Qty.: 1	 Qty.: 1	 Qty.: 2	 Qty.: 1

③ How to Install

1. Selecting the location where the communication control box is to be installed.

Please install it in the ceiling and close to the electronic control box of indoor unit.

2. Connecting the central control box

① Connecting with the indoor unit by the communication line.

Connect the central control box with the indoor unit using the connecting supplied with the equipment, as shown in Figure 1. To prevent looseness of connector due to tensioning, use the line buckle (to be supplied with the equipment) to bind connecting cord, and fasten it to the hook, as shown in fig.1.

4. Control Box(B542(E))

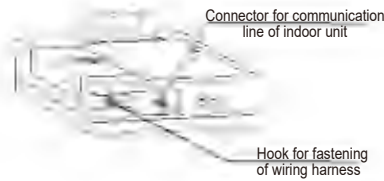

fig. 1 Connecting with indoor unit by communication line

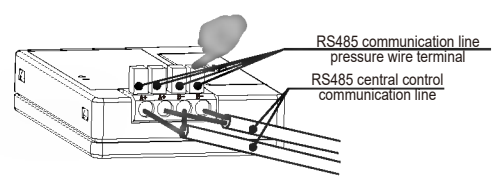

fig. 2 Connection of RS485 control communication line

② Connection of central control communication line.

As shown in fig. 2, press the connection terminal and insert the RS485 communication line into the connecting hole. Then release the terminal until the communication line is properly inserted.

—	Type	Minimum Specifications
RS485 control communication line	Shielded twisted pairs	Cross-sectional area: 2×0.75 mm ²

NOTE:

1. The above requirement for wiring is the minimum;
2. RS485 control communication line should be provided by users;
3. Correct polarity of the communication line should be ensured during connection;
4. The connecting cord should be reliably secured after the connection is completed.

3. Setting of DIP Switches

Please set DIP switches according to the actual conditions.

For the configuration of one slave, set DIP switch as SW1; for two slaves, set as SW1 and SW2 respectively; for three slaves, set as SW1, SW2 and SW3.

Settings after power on will not take effect.

Methods for setting DIP switches:

Before setting, slide down the cover on the communication control box to set the DIP switches.

After setting, reinstall the cover to the communication box.



Fig. 3 Methods for Setting DIP Switches

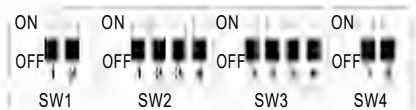

NOTE:

Symbol "■" indicates the position of the DIP switch.

DIP Switch	Description	Setting Method
SW1-1	Setting when fuse operates	Set the position of the switch to "ON" when the fuse on the electronic control board of central control box operates to disconnect the circuit so as to restore the fuse.
SW1-2	Setting for terminal resistor	Be sure to set the position of the switch on either end of the RS485 system to "ON".
SW2 SW3	Setting of addresses	SW2: for setting high address; SW3: for setting low addresses. Range of addresses: 1-3
SW4	Setting of baud rate	00 9600bps (by default), 01: 19200bps. It must set as 00.

4. Securing the Central Control Box

If necessary, use double-faced adhesive tape to secure the communication control box onto the indoor unit after installation.

4. Control Box (B543(E))

4.3 Central Control Box (B543(E))

① Important Notice

Please read the Important Notice in these Installation Instructions supplied with the product, and perform installation in accordance with these instructions properly.

The central control box is a dedicated device that can be directly connected with the indoor unit for converting communication protocols and connects the indoor unit to central control network.

Precautions for arrangement:

1. The design and installation of the central control box should be performed under the unified planning for central control system. The installation location of the central box, electrical distribution and wiring, address assignment, connection with Modbus monitor and indoor unit should be planned in advance.
2. Cables for central control and distribution lines shall not be too close to each other or routed in the same conduit. RS485 bus should be arranged as far away from interference sources as possible, especially high voltage interference sources, such as transformer and frequency converter. For other relevant precautions, see the requirements for wiring of building automation system.
3. The equipment on either end of the group control bus must be provided with terminal-matched resistor.
4. The central control line must be configured as a daisy-chain bus topology. If a star-type or tree topology is required, it is recommended to use RS-485 hub and RS-485 repeater.
5. The central control box should be installed close to the electronic control box of the indoor unit.
6. The baud rate of the adaptor must be set the same with Modbus monitor.
7. The addresses for the central control box should not be repeated.
8. The maximum allowable length of the connecting cable between the indoor unit and the central control box is 40m, and the maximum allowable length of RS485 control cable is 1000m.



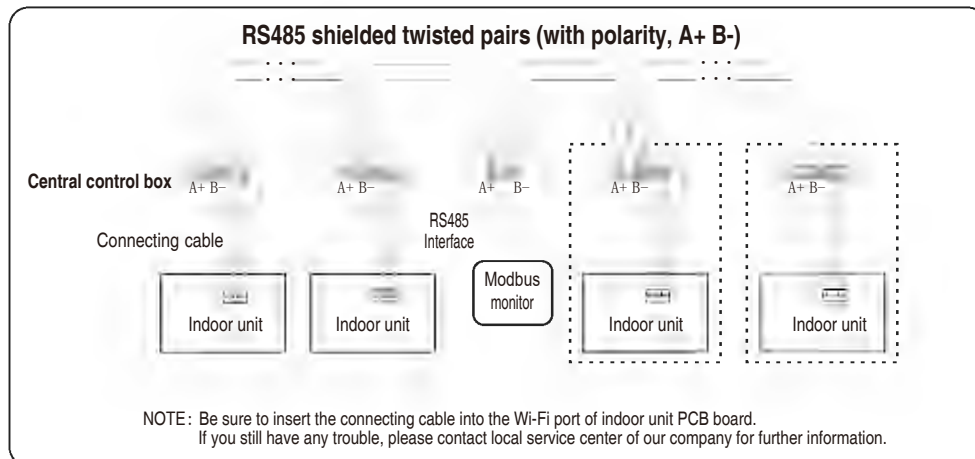

Wiring diagram



4. Control Box (B543(E))

2 Checking accessories

Check and confirm that in addition to the central control box product the following accessories are included in the packaging box.

Installation instructions	Connecting cable	Clamp	Double-sided tape
 Qty.: 1	 (505mm) Qty.: 1	 Qty.: 2	 Qty.: 1

3 How to install

1. Selecting the location where the appliance is to be installed. Please install it in the ceiling and close to the electrical control box of indoor unit.

2. Wiring connection

① Connection with indoor unit by connecting cable.

Connect the central control box with the indoor unit using the connecting cable (attached with the product), as shown in Figure 1. To prevent looseness of connector due to tensioning, use the clamp (attached with the product) to bind connecting cable, and fasten it to the hook, as shown in Fig. 1.

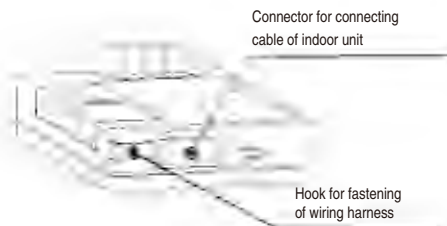

Fig. 1 Connection with indoor unit by connecting cable

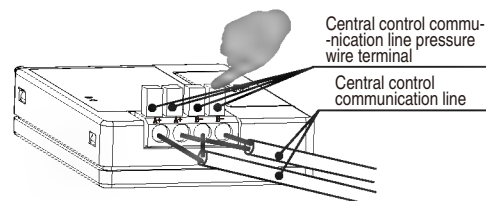

Fig. 2 Connection of central control communication line

② Connection of central control communication line.

As shown in fig. 2, press the connection terminal for central control and insert the communication line for central control into the connecting hole. Then release the terminal until the communication line is properly inserted.

———	Type	Minimum Specifications
Central control communication line	Shielded twisted pairs	Cross-sectional area: $2 \times 0.75 \text{ mm}^2$

NOTE:

1. The above requirement for wiring is the minimum;
2. The central control communication line should be provided by users;
3. Correct polarity of the communication line should be ensured during connection;
4. The cable should be reliably secured after connection is completed.

4. Control Box (B543(E))

3. Setting of DIP Switches

Please set DIP switches according to the actual conditions. Settings after power on will not take effect.

Methods for setting DIP switches:

Before setting, slide down the cover on the central control box to set the DIP switches.

After setting, reinstall the cover to the central control box.



Fig. 3 Methods for setting DIP switches



NOTE:

Symbol "■" indicates the position of the DIP switch.

DIP Switch	Description	Setting Method
SW1-1	Setting when fuse operates	Set the position of the switch to "ON" when the fuse on the electrical control board of central control box blows, so as to restore the fuse.
SW1-2	Setting for terminal resistor	Be sure to set the position of the switch on either end of the central control system to "ON".
SW2 SW3	Setting of addresses	SW2: for setting high address (when more than 16 indoor units are used); SW3: for setting low addresses. Range of addresses: 1~128.
SW4	Setting of baud rate	00 9600bps (by default), 01: 19200bps It must set as 00. Baud rate should be the same with the central control system appliance.

4. Securing the central control box

If necessary, use double-sided tape to secure the central control box onto the indoor unit after installation.

4. Control BOX (B544(E))

4.4 Central Control Adaptor (B544(E))

1 Important Notice

Please read the Important Notice in these Installation Instructions supplied with the product, and perform installation in accordance with these instructions properly.

The central control adaptor is a dedicated device that can be directly connected with the indoor unit for converting communication protocols and connects the indoor unit to central control network.

Precautions for arrangement:

1. The design and installation of the central control adaptor should be performed under the unified planning for central control system. The installation location of the central adaptor, electrical distribution and wiring, address assignment, connection with Modbus monitor and indoor unit should be planned in advance.
2. Cables for central control and distribution lines shall not be too close to each other or routed in the same conduit. RS-485 bus should be arranged as far away from interference sources as possible, especially high voltage interference sources, such as transformer and frequency converter. For other relevant precautions, see the requirements for wiring of building automation system.
3. The equipment on either end of the group control bus must be provided with terminal-matched resistor.
4. The central control line must be configured as a daisy-chain bus topology. If a star-type or tree topology is required, it is recommended to use RS-485 hub and RS-485 repeater.
5. The central control adaptor should be installed close to the electronic control adaptor of the indoor unit.
6. The baud rate of the adaptor must be set the same with Modbus/ BACnet monitor.
7. The addresses for the central control adaptor should not be repeated.
8. The maximum allowable length of the connecting cable between the indoor unit and the central control adaptor is 40m, and the maximum allowable length of RS485 control cable is 1000m.

Wiring diagram

Wiring diagram for twin system

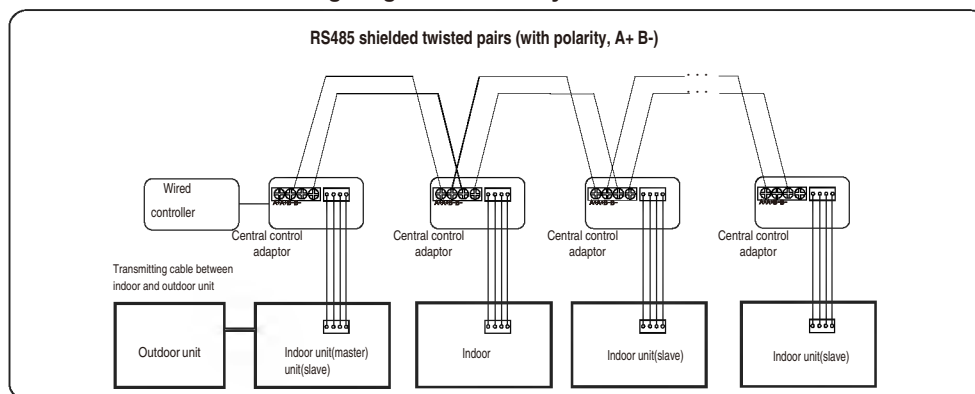

Wiring diagram for centralized control system (BACnet/ModBus)

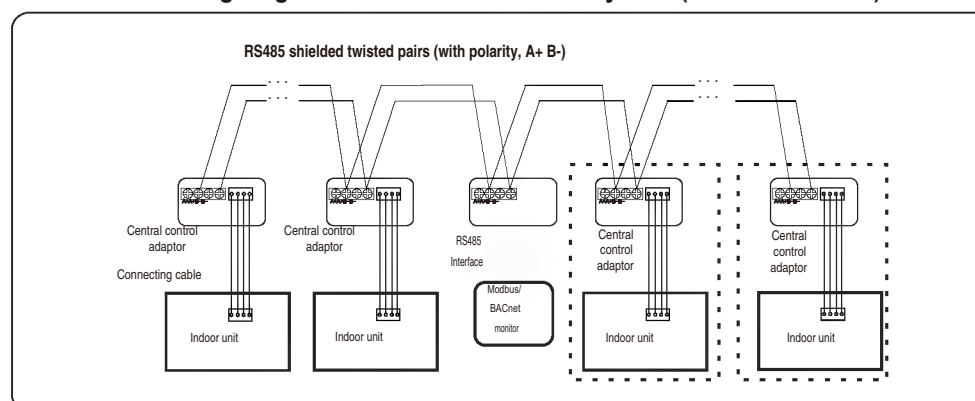





NOTE: Be sure to insert the connecting cable into the wired controller port of indoor unit PCB board.
If you still have any trouble, please contact local service center of our company for further information.

4. Control BOX (B544(E))

2 Checking accessories

Check and confirm that in addition to the central control adaptor product the following accessories are included in the packaging box.

Installation instructions	Connecting cable	Clamp	Double-sided tape
 Qty.: 1	 Qty.: 1	 Qty.: 2	 Qty.: 1

3 How to install

1. Selecting the location where the appliance is to be installed.

Please install it in the ceiling and close to the electrical control adaptor of indoor unit.

2. Wiring connection

① Connection with indoor unit by connecting cable. As shown in Fig.1.

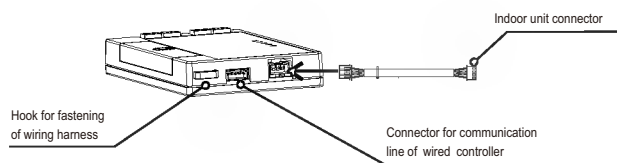

Fig. 1 Connection with indoor unit by connecting cable

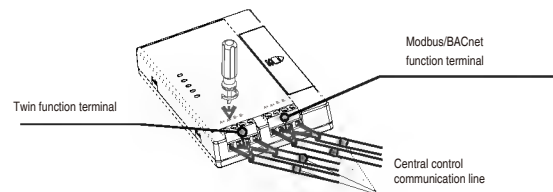

Fig. 2 Connection of central control communication line

② Connection of central control communication line, as shown in Fig. 2.

—	Type	Minimum Specifications
Central control communication line	Shielded twisted pairs	Cross-sectional area: $2 \times 0.75 \text{ mm}^2$

NOTE:

1. The above requirement for wiring is the minimum;
2. The central control communication line should be provided by users;
3. Correct polarity of the cable should be ensured during connection;
4. The cable should be reliably secured after connection is completed.

4. Control BOX (B544(E))

3. Setting of DIP Switches

Please set DIP switches according to the actual conditions. Settings after power on will not take effect. Methods for setting DIP switches:

Before setting, slide down the cover on the central control adaptor. After setting, reinstall the cover to adaptor. As shown in Fig.3.

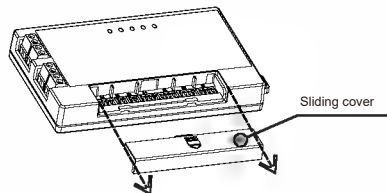
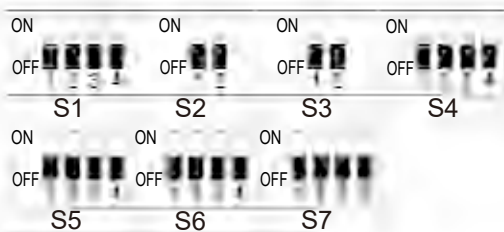

Fig. 3 Methods for setting DIP switches



Note: Symbol "■" indicates the position of the DIP switch.

System	DIP switch	Description	Setting method
Twin system	S1-1 S1-2	Indoor unit setting (hardware)	00: Slave Indoor 11: Master Indoor
	S1-3	Setting for terminal resistor	Be sure to set the position of the switch on either end of the central control system to "ON".
	S1-4	Setting when fuse is fail to work	Set the position of the switch to "ON" to restore the fuse.
	S4-1	Setting for specific products	Set the position of the switch to "ON" when using the following products: HCWA21NEHH HCWA22NEHH
	S4-2	Indoor unit setting (software)	0: Slave Indoor 1: Master Indoor
	S5	Slave indoor address/Number of slave indoors	When the central control adaptor is set as slave, S5 is set as slave address, which range is 1-15; When the central control adaptor is set as master, S5 is set as slaves' number, which range is 1-15.

Note: 1. The slave indoor address must be incremented form1.
2. When the twin system is not used, set S4-2 and S5 off.

System	DIP switch	Description	Setting method
Centralized control system	S2-1	Setting for terminal resistor	Be sure to set the position of the switch on either end of the central control system to "ON".
	S2-2	Setting when fuse is fail to work	Set the position of the switch to "ON" to restore the fuse
	S3	Setting of baud rate	00: 9600bps(by default). 01: 19200bps; 10: 38400bps.
	S4-3 S4-4	Protocol selection	00: Not connected to centralized control syestem (default setting); 01: BACnet; 10: ModBus.
	S6 S7	Setting of BACnet/ ModBus addresses	S6: for setting high address(reserve); S7: for setting low addresses. Range of addresses: 1~255.
	<p>00000001 (address: 1) 11111111 (address: 255)</p>		

Note: 1. If the system is connected to C01T, the address should not be greater than16.
2. When the centralized control system is not used, set S4-3, S4-4, S6 and S7 off.

4. Securing the central control box

If necessary, use double-sided tape to secure the central control box onto the indoor unit after installation.

4. Control BOX (B544(E))

4 MODEBUS Protocol

1. Function code

Address code: The address code is set by the DIP switch.

Function code: The function code is as follows:

Code	Function
01	Read Coils
02	Read Discrete Inputs
03	Read Holding Registers
04	Read Input Registers
05	Write Single Coil
06	Write Single Holding Register

2. Definition of registers

(1) Instruction of the registers

Coil and Hold Registers are for setting air conditioner parameters.

Discrete Inputs and Input Registers are for reading air conditioner status.

(2) Definition of registers as follows:

Read Discrete Inputs (Code 0x02)

No.	Object	Type	Addr	Value	Comment
00001	ON/OFF status	BI	0000	0-OFF/1-ON	
00002	Sleep status	BI	0003	0-OFF/1-ON	
00003	Electric heater status	BI	0004	0-OFF/1-ON	
00004	Energy-saving status	BI	0009	0-OFF/1-ON	
00005	Defrost status	BI	0010	0-No/1-Yes	
00006	Compressor status	BI	0011	0-OFF/1-ON	
00007	Super mode	BI	0014	0-No/1-Yes	
00008	Mute mode	BI	0015	0-No/1-Yes	

Read Input Registers (0x04)

No.	Object	Type	Reg Addr	Value	Comment
00001	Indoor temperature	AI	0001	-20-79	
00002	The setting temperature	AI	0002	18-32	
00003	Mode	MI	0007	FAN=00; HEAT=01; COOL=02; DRY=03; AUTO CODE=05; AUTO HEAT=06 AUTO FAN=07;	
00004	Fan speed	MI	0008	AUTO=00; HIGH=01 MIDDLE=03; LOW=02	
00005	Swing	MI	0009	NO SWING=0; LEFT/RIGHT=1; UP/DOWN=2; UP/DOWN/LEFT/RIGHT=3	
00006	Fault	MI	0012	1-255	See Error Code table
00007	Outlet air temperature	AI	0015	-20-79	

4. Control BOX (B544(E))

Write Coil (Code 0x05)

No.	Object	Type	Addr	Value	Comment
00001	ON/OFF setting	BV	0000	0-OFF/1-ON	
00002	Sleep setting	BV	0003	0-No/1-Yes	
00003	Electric heater setting	BV	0004	0-No/1-Yes	
00004	Energy-saving mode	BV	0009	0-No/1-Yes	
00005	Super mode	BV	0013	0-No/1-Yes	
00006	Mute mode	BV	0014	0-No/1-Yes	

Write Holding Registers (0x06)

No.	Object	Type	Addr	Value	Comment
00001	Temperature setting	AV	0000	18-32	
00002	Mode setting	MO	0002	FAN=00; HEAT=01; COOL=02; DRY=03; AUTO=04	
00003	Fan speed setting	MO	0003	AUTO=00; HIGH=01 MIDDLE=03; LOW=02	
00004	Swing setting	MO	0004	NO SWING=0; UP/DOWN=1 LEFT/RIGHT=2 UP/DOWN/LEFT/RIGHT=3	

5

BACnet MSTP Protocol

1. Introduction

This document contains the Protocol Implementation Conformance Statement (PICS) and BACnet® Interoperability Building Blocks (BIBBs) for B544(E) as required by the American National Standards Institute/American Society of Heating, Refrigerating, and Air-Conditioning Engineers (ANSI/ASHRAE) Standard 135-2004, BACnet protocol.

The PICS is a written document created by the manufacturer of a device to identify the particular options specified in the BACnet standard and implemented in the device.

BACnet interoperability building blocks are collections of one or more BACnet services. This document includes a listing of the BIBBs currently.

2. Annex A - Protocol Implementation Conformance Statement (Normative)

Table 1: BACnet Protocol Implementation Conformance Statement

Vendor Name	Hisense Kelon Air-conditioning Corporation
Product Name	Central Control Adaptor
Product Model Numbers	B544(E)
Applications Software Version	1.0.0
Firmware Version	0.5.2
BACnet Protocol Revision	Version 1, Revision 4

Product Description

The B544(E) central control adaptor provides functionality to allow other BACnet devices to read and write properties of BACnet-enabled Hisense devices and objects.

4. Control BOX (B544(E))

BACnet Standardized Device Profile (Annex L)

- BACnet Operator Workstation (B-OWS)
- BACnet Building Controller (B-BC)
- BACnet Advanced Application Controller (B-AAC)
- BACnet Application Specific Controller (B-ASC)
- BACnet Smart Sensor (B-SS)
- BACnet Smart Actuator (B-SA)

Note: Note:For a complete listing of the additional BIBBs supported (Annex K), see the *Annex K - BACnet Interoperability Building Blocks (BIBBs) (Normative)* section of this document.

Segmentation Capability

- Segmentation Requests Supported Window Size 127
 - Segmentation Responses Supported Window Size 127
-

Standard Object Types Supported

The following is a list of the standard object types as defined by ASHRAE. Refer to the section of the supported object type for details.

- Analog Input
- Analog Output
- Analog Value
- Averaging
- Binary Input
- Binary Output
- Binary Value
- Calendar
- Command
- Device
- Event
- Enrollment
- File
- Group
- Life
- Safety Point
- Life Safety Zone
- Loop
- Multistate Input
- Multistate Output
- Multistate Value
- Notification Class
- Program
- Schedule
- Trend Log

4. Control BOX (B544(E))

Analog Input

Table 1: Analog Input

Dynamically Creatable	Dynamically Deletable	Optional Properties Supported	Writable Properties
<input type="checkbox"/>	<input type="checkbox"/>		Present Value

Analog Output

Table 2: Analog output

Dynamically Creatable	Dynamically Deletable	Optional Properties Supported	Writable Properties
<input type="checkbox"/>	<input type="checkbox"/>		Present Value

Analog Value

Table 3: Analog Value

Dynamically Creatable	Dynamically Deletable	Optional Properties Supported	Writable Properties
<input type="checkbox"/>	<input type="checkbox"/>		Present Value

Binary Input

Table 4: Binary Input

Dynamically Creatable	Dynamically Deletable	Optional Properties Supported	Writable Properties
<input type="checkbox"/>	<input type="checkbox"/>		Present Value

Binary Output

Table 5: Binary Output

Dynamically Creatable	Dynamically Deletable	Optional Properties Supported	Writable Properties
<input type="checkbox"/>	<input type="checkbox"/>		Present Value

Binary Value

Table 6: Binary Value

Dynamically Creatable	Dynamically Deletable	Optional Properties Supported	Writable Properties
<input type="checkbox"/>	<input type="checkbox"/>		Present Value

Device

Table 7: Device

Dynamically Creatable	Dynamically Deletable	Optional Properties Supported	Writable Properties
<input type="checkbox"/>	<input type="checkbox"/>		

4. Control BOX (B544(E))

Data Link Layer Option

- ACnet Internet Protocol (IP) (Annex J)
- BACnet IP (Annex J), Foreign Device
- ISO 8802-3, Ethernet (Clause 7)
- ANSI/ATA 878.1, 2.5 MB ARCNET® network (Clause 8)
- ANSI/ATA 878.1, RS-485 ARCNET network (Clause 8), baud rates:
- Master-Slave/Token-Passing (MS/TP) master (Clause 9), baud rates: 9600,19200,38400
- MS/TP slave (Clause 9), baud rates: 9600,19200,38400
- Point-To-Point, EIA 232 (Clause 10), baud rates:
- Point-To-Point, modem (Clause 10), baud rates:
- LonTalk® protocol (Clause 11), medium:
- Other:

Device Address Binding

- Yes No **Is static device binding supported?** (required for two-way communication between MS/TP slaves and other devices) Networking Options

Networking Options

- Router, Clause 6: _____ Annex
- H, BACnet Tunneling Router over IP
- BACnet/IP Broadcast Management Device (BBMD)
Does the BBMD support registrations by Foreign Devices? Yes No

Character Sets Supported

Indicating support for multiple character sets does not imply that they can all be supported simultaneously.

- | | | |
|--|---|---|
| <input checked="" type="checkbox"/> ANSI X3.4 | <input type="checkbox"/> IBM®/Microsoft® Double-Byte Character Set (DBCS) | <input type="checkbox"/> ISO 8859-1 Japanese |
| <input type="checkbox"/> ISO 10646 Universal Character Set-2 (UCS-2) | <input type="checkbox"/> ISO 10646 (UCS-4) | <input type="checkbox"/> Industrial Standard (JIS) C 6226 |

If this product is a communication gateway, describe the types of non BACnet equipment/network(s) that the gateway supports:

4. Control BOX (B544(E))

2. Annex K - BACnet Interoperability Building Blocks (BIBBs)

(Normative)

Table 1 lists all the BIBBs which, per ANSI/ASHRAE Standard 135-2004, could be supported by a BACnet Specific Controller (B-ASC). The checked BIBBs are supported by B544(E).

Table 1: B544(E) BIBBs Support

Application Service (B-SS)	Designation	Support
Data Sharing - Read Property - A	DS-RP-A	<input type="checkbox"/>
Data Sharing - Read Property - B	DS-RP-B	<input checked="" type="checkbox"/>
Data Sharing - Read Property Multiple - A	DS-RPM-A	<input type="checkbox"/>
Data Sharing - Read Property Multiple - B	DS-RPM-B	<input type="checkbox"/>
Data Sharing - Write Property - A	DS-WP-A	<input type="checkbox"/>
Data Sharing - Write Property - B	DS-WP-B	<input checked="" type="checkbox"/>
Data Sharing - Write Property Multiple - A	DS-WPM-A	<input type="checkbox"/>
Data Sharing - Write Property Multiple - B	DS-WPM-B	<input type="checkbox"/>
Data Sharing - COV - Unsolicited - A	DS-COVU-A	<input type="checkbox"/>
Data Sharing - COV - Unsolicited - B	DS-COVU-B	<input checked="" type="checkbox"/>
Alarm and Event - Notification Internal - B	AE-N-I-B	<input type="checkbox"/>
Alarm and Event - ACK - B	AE-ACK-B	<input type="checkbox"/>
Alarm and Event - Information - B	AE-INFO-B	<input type="checkbox"/>
Alarm and Event - Enrollment Summary - B Scheduling - External - B	AE-ESUM-B SCHED-E-B	<input type="checkbox"/>
Trending - Viewing and Modifying Trends Internal - B	T-VMT-I-B	<input type="checkbox"/>
Trending - Automated Trend Retrieval - B	T-ATR-B	<input type="checkbox"/>
Device Management - Dynamic Device Binding - A	DM-DDB-A	<input type="checkbox"/>
Device Management - Dynamic Device Binding - B	DM-DDB-B	<input checked="" type="checkbox"/>
Device Management - Dynamic Object Binding - A	DM-DOB-A	<input type="checkbox"/>
Device Management - Dynamic Object Binding - B	DM-DOB-B	<input checked="" type="checkbox"/>
Device Management - Device Communication Control - B	DM-DCC-B	<input type="checkbox"/>
Device Management - Time Synchronization - B	DM-TS-B	<input checked="" type="checkbox"/>
Device Management - UTC Time Synchronization - B	DM-UTC-B	<input type="checkbox"/>
Device Management - Reinitialize Device - B Device Management - Backup and Restore - B	DM-RD-B DM-BR-B	<input type="checkbox"/>

4. Control BOX (B544(E))

Network Management - Connection Establishment - A NM-CE-A

Figure 2 lists all the BACnet standard application services. The checked services are supported by B544(E).

Table 2: BACnet Standard Application Services Support (Part 1 of 2)

Application Service	Initiates Requests	Executes Requests
AcknowledgeAlarm	<input type="checkbox"/>	<input type="checkbox"/>
AddListElement	<input type="checkbox"/>	<input type="checkbox"/>
AtomicReadFile	<input type="checkbox"/>	<input type="checkbox"/>
AtomicWriteFile	<input type="checkbox"/>	<input type="checkbox"/>
ConfirmedCOVNotification	<input checked="" type="checkbox"/>	<input type="checkbox"/>
ConfirmedEventNotification	<input type="checkbox"/>	<input type="checkbox"/>
ConfirmedPrivateTransfer	<input type="checkbox"/>	<input type="checkbox"/>
ConfirmedTextMessage CreateObject	<input type="checkbox"/>	<input type="checkbox"/>
DeleteObject	<input type="checkbox"/>	<input type="checkbox"/>
DeviceCommunicationControl	<input type="checkbox"/>	<input type="checkbox"/>
Disconnect-Connection-To-Network	<input type="checkbox"/>	<input type="checkbox"/>
Establish-Connection-To-Network	<input type="checkbox"/>	<input type="checkbox"/>
GetAlarmSummary	<input type="checkbox"/>	<input type="checkbox"/>
GetEnrollmentSummary	<input type="checkbox"/>	<input type="checkbox"/>
GetEventInformation	<input checked="" type="checkbox"/>	<input type="checkbox"/>
I-Am	<input type="checkbox"/>	<input checked="" type="checkbox"/>
I-Am-Router-To-Network	<input type="checkbox"/>	<input type="checkbox"/>
I-Could-Be-Router-To-Network	<input type="checkbox"/>	<input type="checkbox"/>
I-Have	<input type="checkbox"/>	<input type="checkbox"/>
Initialize-Routing-Table	<input type="checkbox"/>	<input type="checkbox"/>
Initialize-Routing-Table-Ack	<input type="checkbox"/>	<input type="checkbox"/>
LifeSafetyOperation ReadProperty	<input type="checkbox"/>	<input checked="" type="checkbox"/>
ReadPropertyConditional	<input type="checkbox"/>	<input type="checkbox"/>
ReadPropertyMultiple ReadRange	<input type="checkbox"/>	<input type="checkbox"/>

4. Control BOX (B544(E))

Network Management - Connection Establishment - A NM-CE-A

Figure 2 lists all the BACnet standard application services. The checked services are supported by B544(E).

Table 2: BACnet Standard Application Services Support (Part 2 of 2)

Application Service	Initiates Requests	Executes Requests
ReinitializeDevice	<input type="checkbox"/>	<input type="checkbox"/>
RemoveListElement	<input type="checkbox"/>	<input type="checkbox"/>
SubscribeCOV	<input type="checkbox"/>	<input checked="" type="checkbox"/>
SubscribeCOVProperty	<input type="checkbox"/>	<input checked="" type="checkbox"/>
TimeSynchronization	<input type="checkbox"/>	<input checked="" type="checkbox"/>
UnconfirmedCOVNotification	<input type="checkbox"/>	<input type="checkbox"/>
UnconfirmedEventNotification	<input type="checkbox"/>	<input type="checkbox"/>
UnconfirmedPrivateTransfer	<input type="checkbox"/>	<input type="checkbox"/>
UnconfirmedTextMessage	<input type="checkbox"/>	<input type="checkbox"/>
TCTimeSynchronization	<input type="checkbox"/>	<input type="checkbox"/>
VT-Close	<input type="checkbox"/>	<input type="checkbox"/>
VT-Data	<input type="checkbox"/>	<input type="checkbox"/>
VT-open	<input type="checkbox"/>	<input type="checkbox"/>
Who-Has	<input type="checkbox"/>	<input type="checkbox"/>
Who-Is	<input type="checkbox"/>	<input checked="" type="checkbox"/>
Who-Is-Router-To-Network	<input type="checkbox"/>	<input type="checkbox"/>
WriteProperty	<input type="checkbox"/>	<input checked="" type="checkbox"/>
WritePropertyMultiple	<input type="checkbox"/>	<input type="checkbox"/>

4. Control BOX (B544(E))

6 Object List

Device Instance: 10000 + Set address

Device MSTP MAC address:16+ Set address

Set address: Set at B544 dip switch

For example:

If the B544(E) dip switch address set to 2, this B544(E) in BACnet MSTP

Device Instance should be 10002, and the MAC address should be 18.

Alog input object

No.	Object	Type	Object Instance	Value	Comment
1	Indoor Temperature	AI	000001	-20-79	
2	Set Temperature	AI	000002	18-32	

Binary input object

No.	Object	Type	Object Instance	Value	Comment
1	ON/OFF Status	BI	000000	0-Off/1-On	
2	SLEEPStatus	BI	000003	0-No/1-Yes	
3	ELECTRICAL	BI	000004	0-No/1-Yes	

Multistate input object

No.	Object	Type	Object Instance	Value	Comment
1	Mode	MI	000001	FAN=00 HEAT=01 COOL=02 DRY=03 AUTO=04	
2	Fan	MI	000002	AUTO=00 HIGH=01 MIDDLE=03 LOW=02	
3	Swing	MI	000003	NO SWING=0 UP/DOWN=1 LEFT/RIGHT=2 UP/DOWN/LEFT/RIGHT=3	
4	Error	MI	000006	1-255	See Error

Analog valve object

No.	Object	Type	Object Instance	Value	Comment
1	Set Temperature	AV	000000	18-32	
2	SetHumidity	AV	000001	0-100%	Reserved

4. Control BOX (B544(E))

Binary value object

No.	Object	Type	Object Instance	Value	Comment
1	ON/OFF	BV	000000	0-OFF/1-ON	
2	NET RESET	BV	000002	0-NO/1-YES	
3	SLEEP	BV	000003	0-NO/1-YES	
4	ELECTRICAL HEAT	BV	000004	0-NO/1-YES	

Multistate output object

No.	Object	Type	Object Instance	Value	Comment
1	MODE	MO	000000	FAN=00 HEAT=01 COOL=02 DRY=03 AUTO=04	
2	FAN	MO	000001	AUTO=00 HIGH=01 MIDDLE=03 LOW=02	
3	SWING	MO	000002	NO SWING=0 UP/DOWN=1 LEFT/RIGHT=2 UP/DOWN/LEFT/RIGH T=3	

5. Trouble Shooting

Please refer to the table below for the troubleshooting of the controller.

Error code	Error description	Possible reasons	How to deal with	Remarks
F0 (240)	EEPROM communicating failure	Communication between EEPROM and MCU fails.	Change the wired controller	The unit can run.
F1 (241)	Wired controller temperature sensor failure	Communication between temperature sensor and MCU fails.	Change the wired controller	The unit can run.
F2 (242)	Wired controller clock IC failure	Communication between Clock IC and MCU fails.	Change the wired controller	The unit can run.
F3 (243)	Wired controller humidity sensor failure	Communication between humidity sensor and MCU fails.	Change the wired controller	The unit can run.
F4 (244)	Wired controller EEPROM data error	1.EE components fail; 2.EE components control circuit fails; 3.EE components are inserted incorrectly.	Change the wired controller	The unit can run.
FA	Brand error between indoor unit and wired controller	Connected to different brand wired controller.	Change the wired controller to the same brand with indoor unit	The unit will stop.
Fb	Error between slave indoor unit and simplified central controller	Communication Error between Slave IDU and simplified central controller	1. Reconnect the connection cable referring to the wiring diagram; 2. Reconnect the communication cable; 3. Replace the communication cable; 4. Replace the indoor control board; 5. Check the communication circuit, adjust the DIP switch	1. Only for simplified central controller 2. The unit will stop.
FC	Unbalanced distribution warming	Coil temperature difference between the master indoor unit and slave indoor unit is too big.	1. Check the installation height difference 2. Check the branch connection pipe. 3. Check the pipe length difference of each indoor unit.	1. Only for simplified central controller 2. The unit will stop.
Fd	Central controller communicating failure	Central controller can not find the wired controller or central control box correctly.	1. Reconnect the connection cable referring to the wiring diagram; 2. Reconnect the communication cable; 3. Replace the communication cable; 4. Replace the indoor control board; 5. Check the communication circuit, adjust the DIP switch	1. Only for central controller 2. The unit will stop.

5. Trouble Shooting

Error code	Error description	Possible reasons	How to deal with	Remarks
FE(254)	Communication between main control board &Wiring remote controller Fault (display on wiring remote controller)	<ol style="list-style-type: none"> 1. The wiring between the wiring controller to the indoor control board connect loose; 2. The sequence of the wiring between the wiring controller to the indoor control board is wrong; 3. The wiring between the wiring controller to the indoor control board is failure; 4. The wiring controller is failure; 5. The indoor control board is abnormally. 	<ol style="list-style-type: none"> 1. Reconnect the wiring between the wiring controller to the indoor control board; 2. Replace the wiring between the wiring controller to the indoor control board; 3. Replace the wiring between the wiring controller to the indoor control board; 4. Replace the wiring controller; 5. Replace the indoor control Board. 	The unit can run.
ER	Communication between main control board &display board Fault (displays on display board)	<ol style="list-style-type: none"> 1. The wiring between the display board to the indoor control board connect loose; 2. The sequence of the wiring between the display board to the indoor control board is wrong; 3. The wiring between the display board to the indoor control board is failure; 4. The display board is failure; 5. The indoor control board is failure. 	<ol style="list-style-type: none"> 1. Reconnect the between the display board to the indoor control board; 2. Replace the wiring between the display board to the indoor control board; 3. Replace the wiring between the display board to the indoor control board; 4. Replace the display board; 5. Replace the indoor control board. 	The unit can run.

Please check the relevant content in the TECHNICAL & SERVICE MANUAL for indoor&outdoor unit troubleshooting.

6. Outlines and Dimensions

YXE-A03U(E)

(Unit: mm)

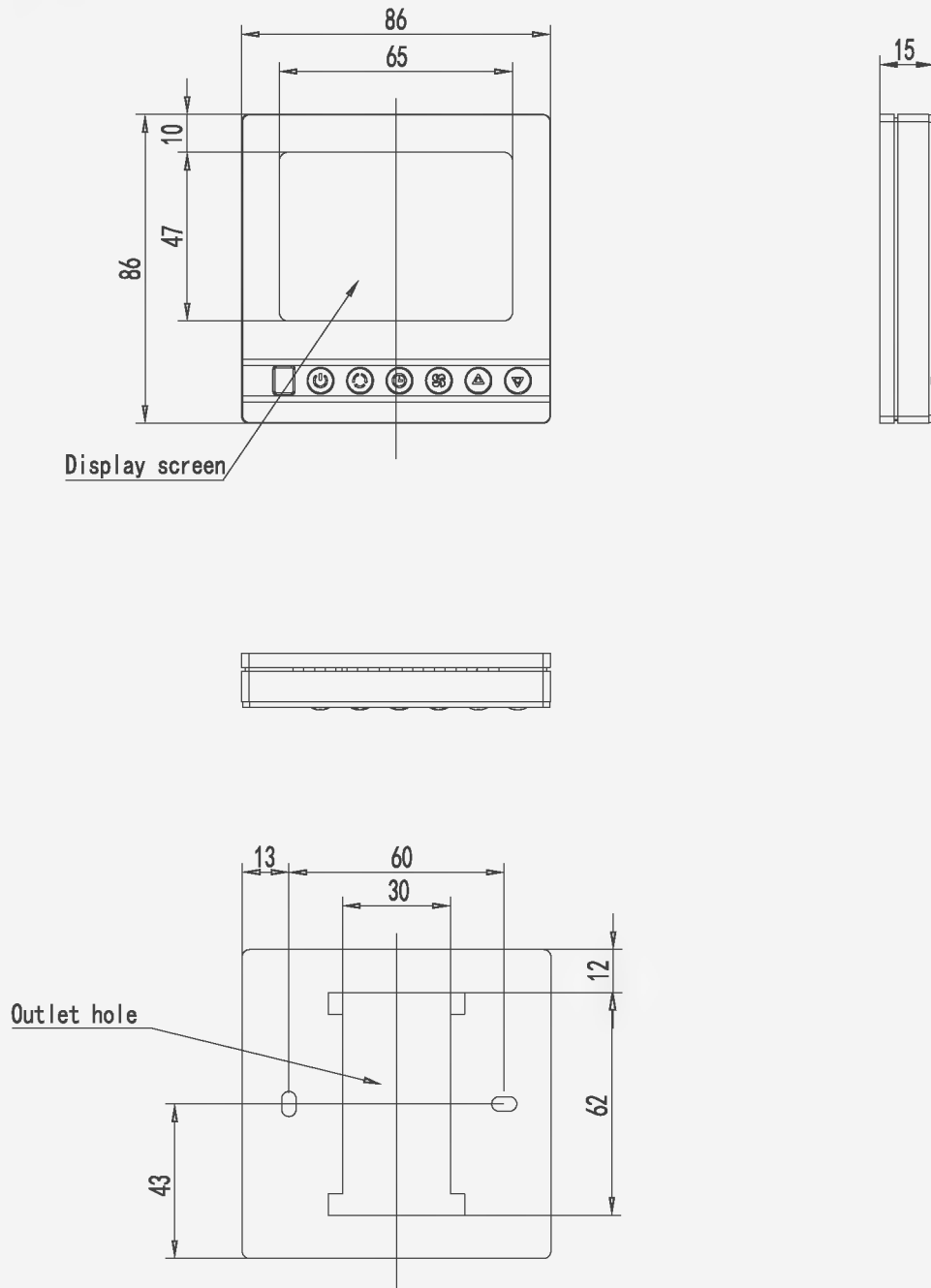

6. Outlines and Dimensions

YXE-C01U1(E)

(Unit: mm)

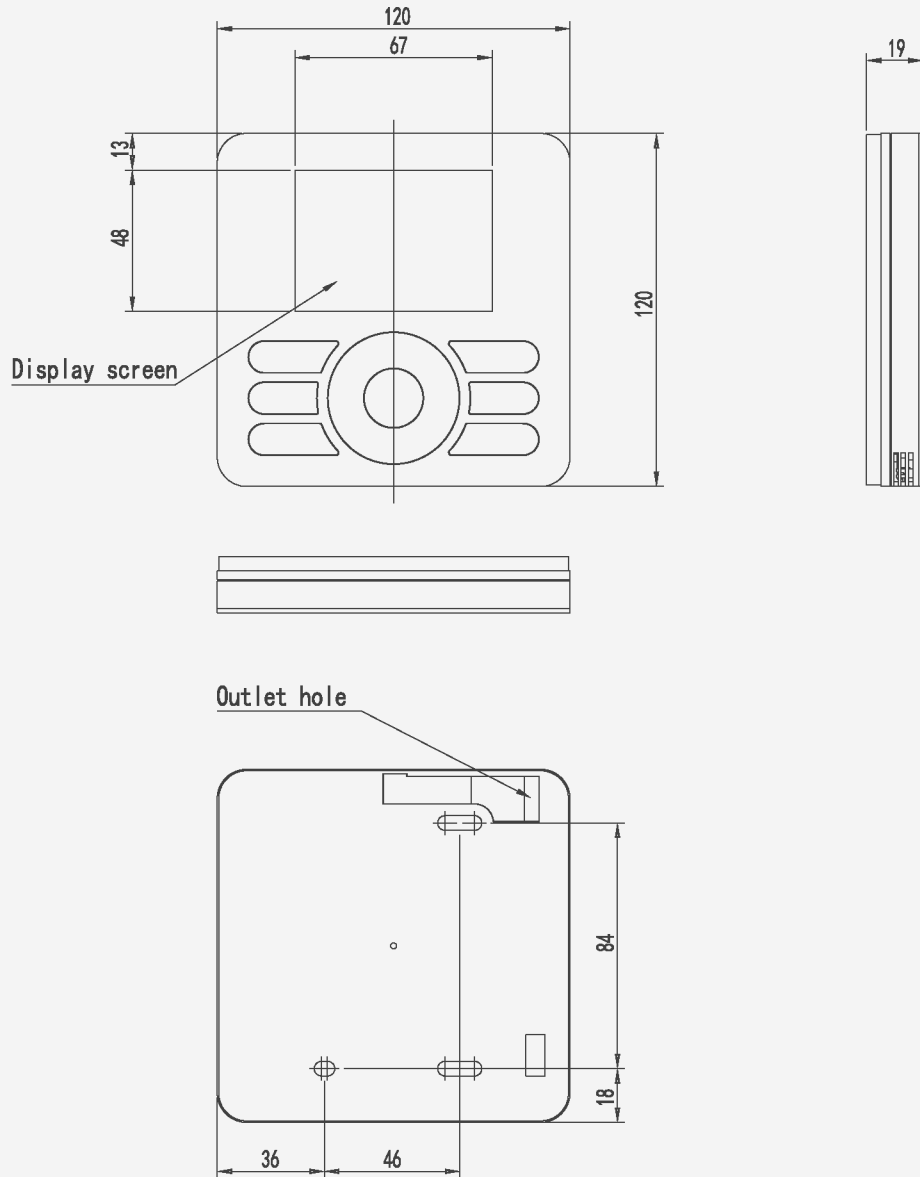

6. Outlines and Dimensions

YXE-C02U1(E) YXE-C03U(E)

(Unit: mm)

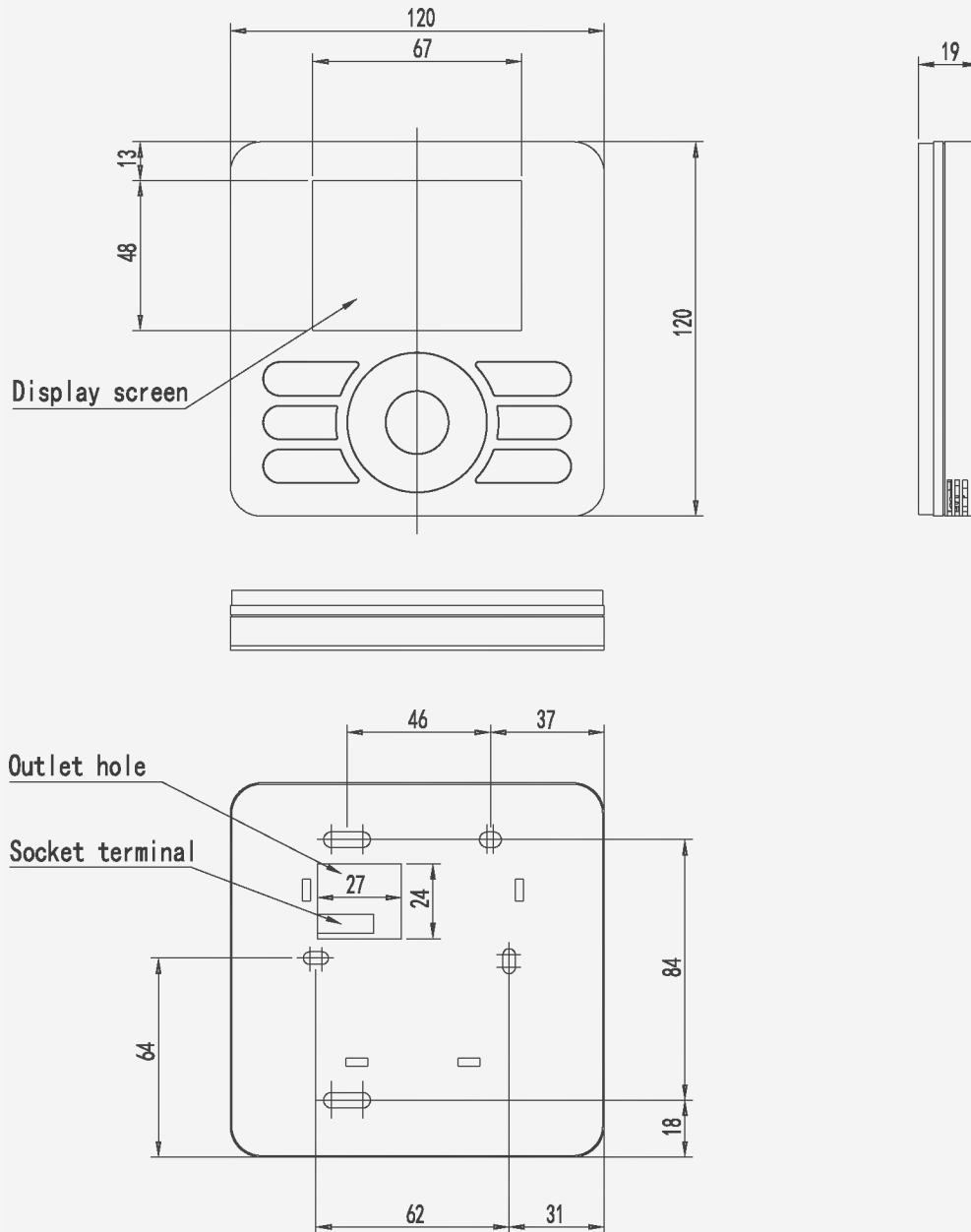

6. Outlines and Dimensions

YXE-E01U(E)/YXE-E02U(E)

(Unit: mm)

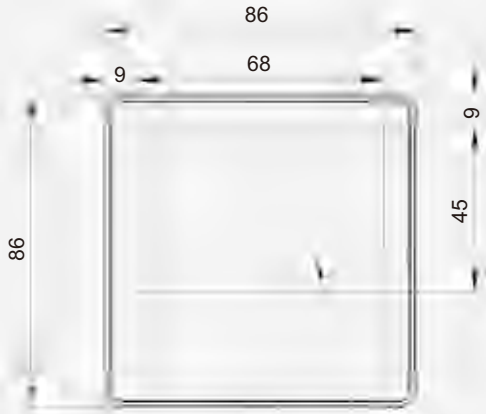

Display screen



Outlet hole

6. Outlines and Dimensions

YJE-C01T(E)

(Unit: mm)

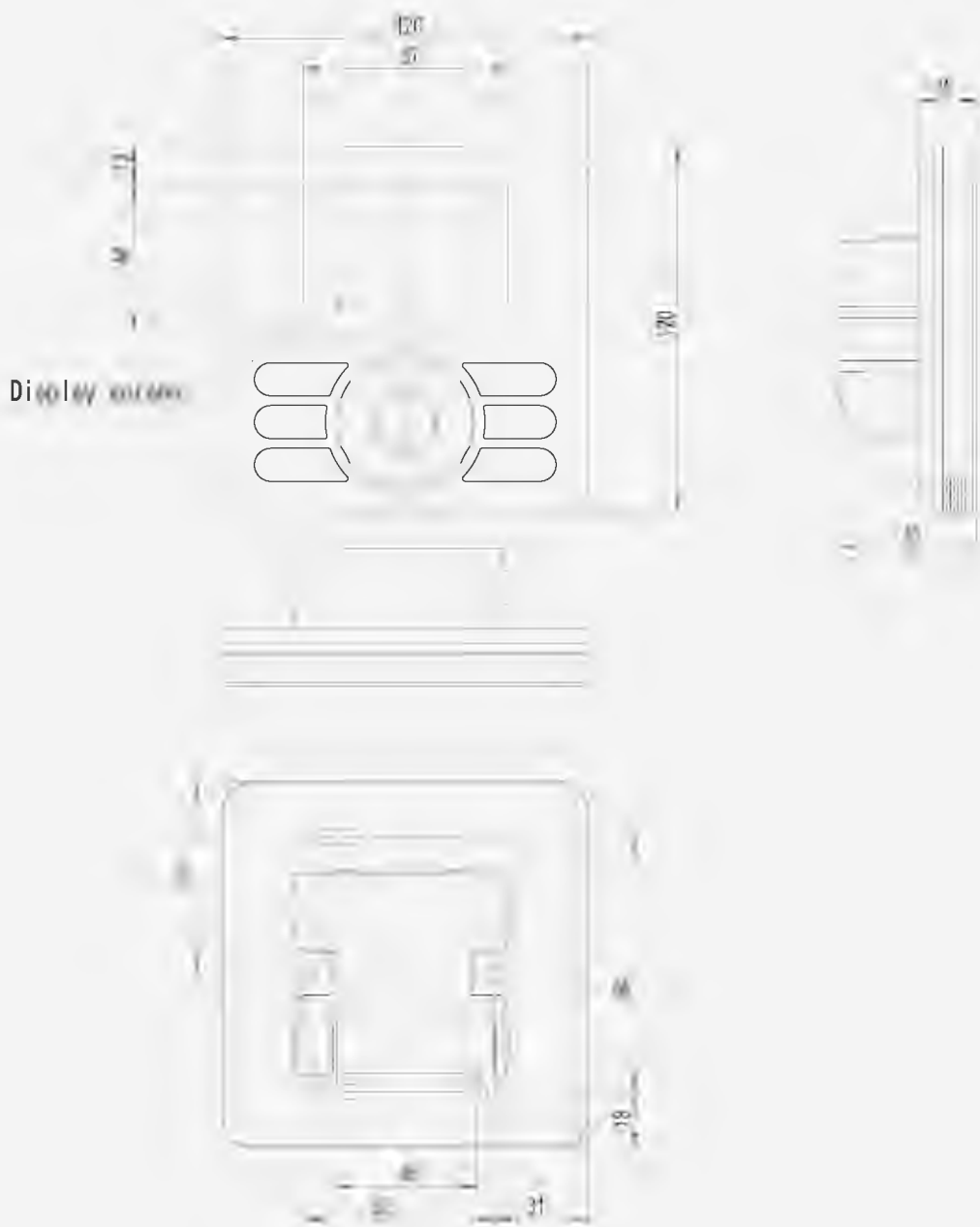

6. Outlines and Dimensions

B541(E) B542(E) B543(E)

(Unit: mm)

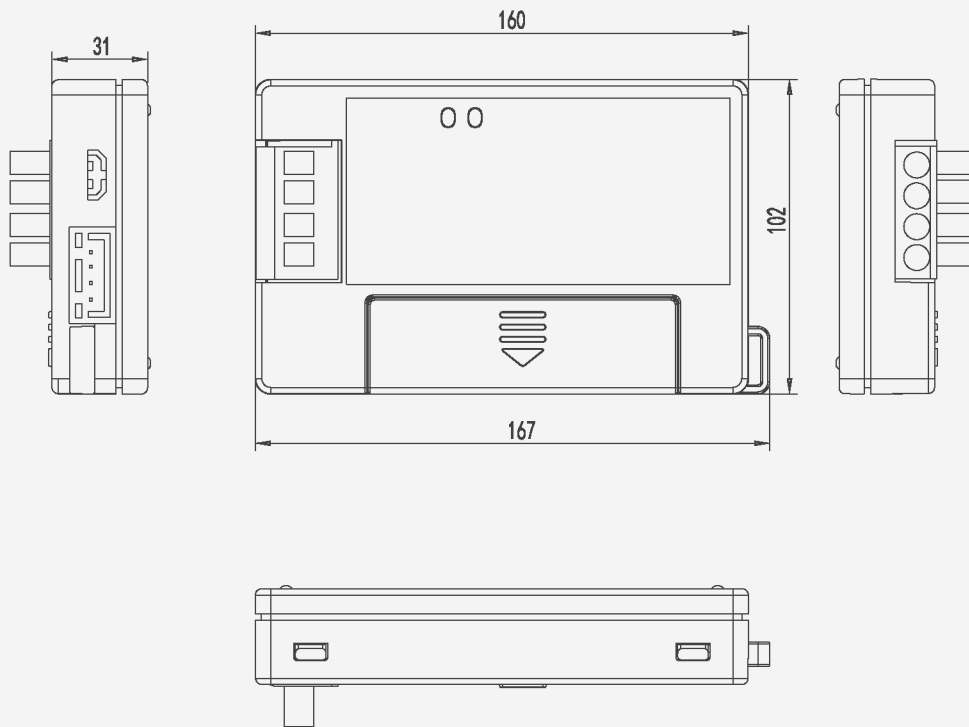

6. Outlines and Dimensions

B544(E)

(Unit: mm)

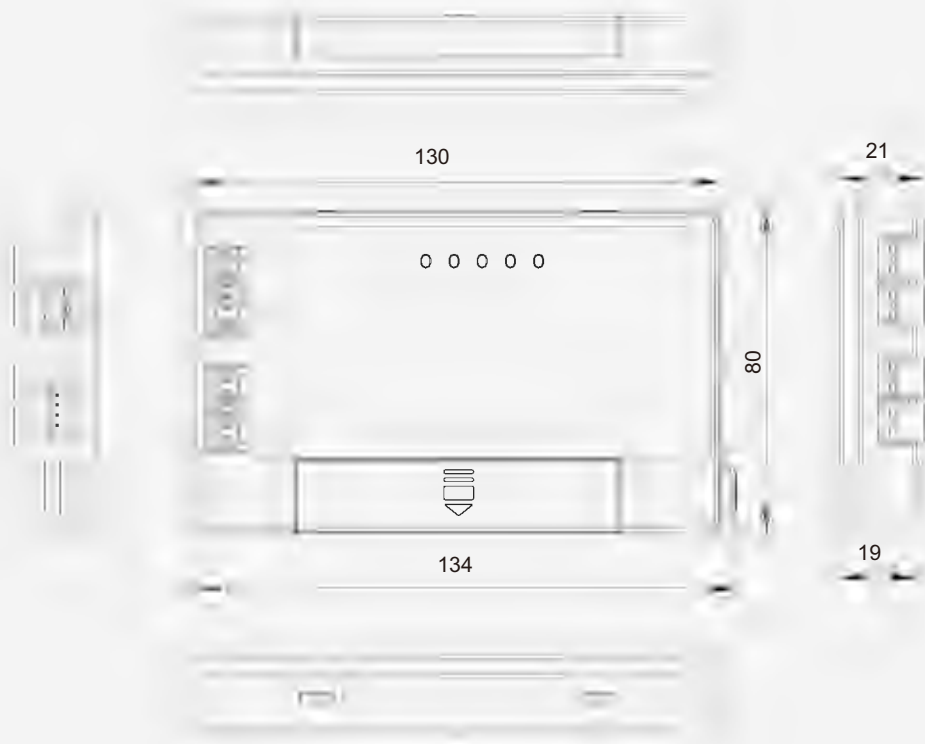

Hisense

Product improvement, specifications and appearance in this manual are subject to change without prior notice.